

RADIO-CRAFT

HUGO GERNSBACK, *Editor*

**OMNIDIRECTIONAL
LOUDSPEAKER**
See Page 10

**RADIO
PARTS SHOW
REVIEW**

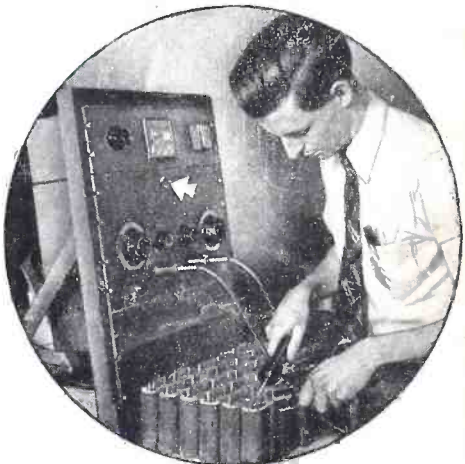

INDUSTRIAL "EYE"



LUFTWAFFE LOOP



ARMY RADIO "PAPER"

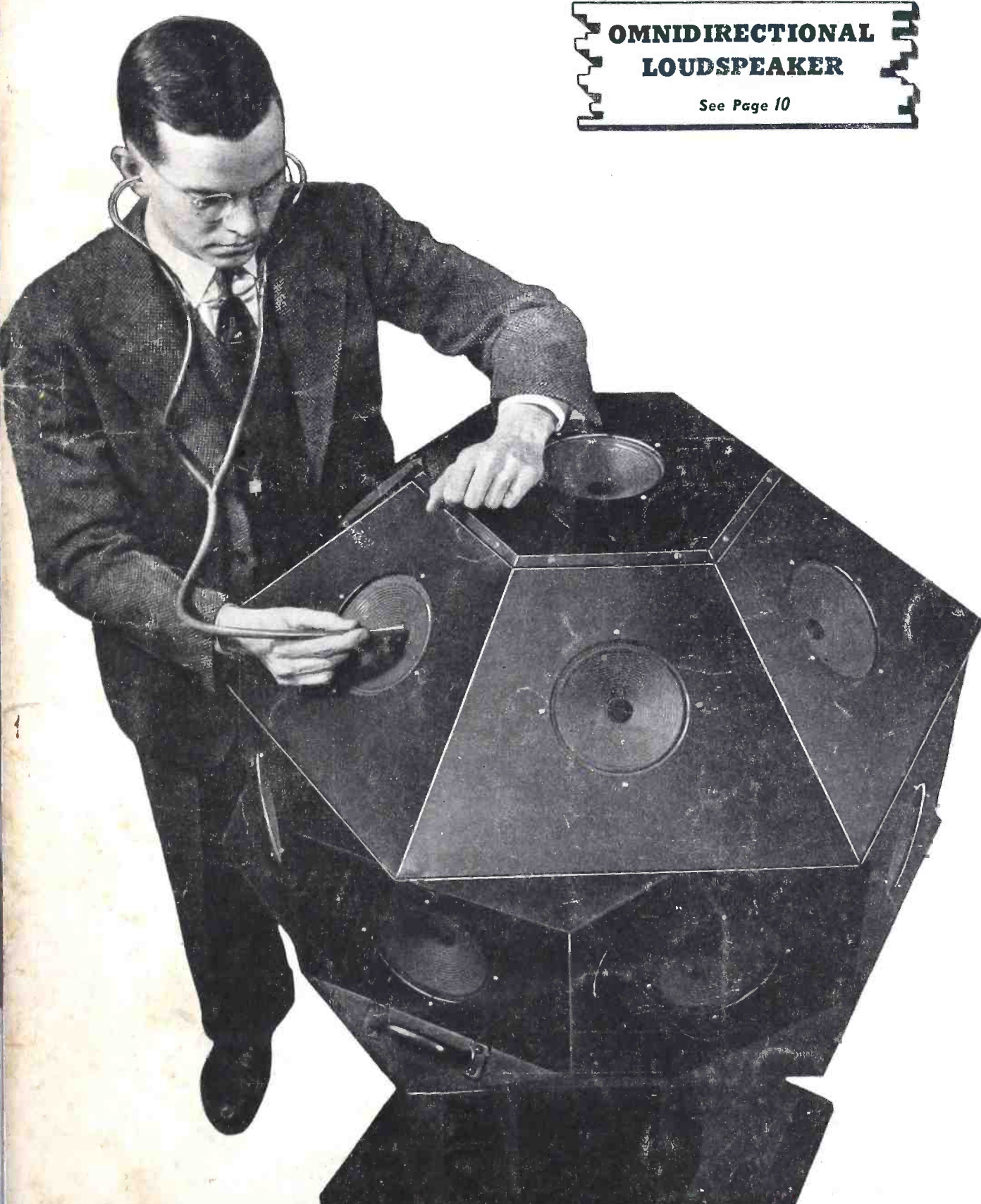

JULY **25c** CANADA 30c 1941 **RADIO'S GREATEST MAGAZINE**

**EXPERIENCES WITH METAL-TREASURE LOCATORS • 1941 AUTO-RADIO CIRCUITS
REJUVENATING DRY-BATTERIES • RECENT TUBES • THE HOW AND WHY OF F. M.**

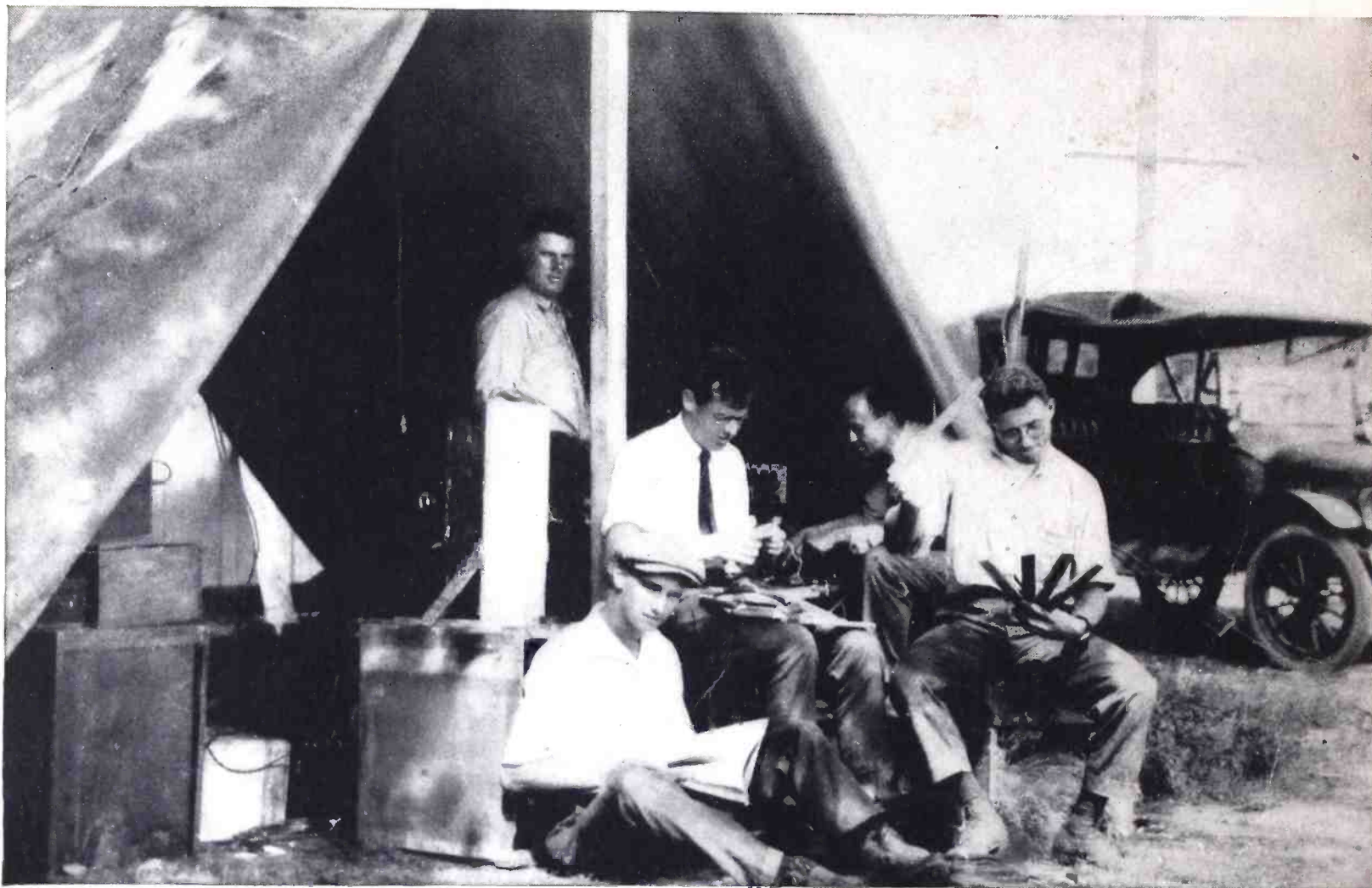

It all started in a tent...

AGAINST the horizon of "the spires of Princeton," the world's largest radio research laboratories are to be built by the Radio Corporation of America at Princeton, New Jersey.

The new RCA Laboratories, to be completed before the year-end, are planned to promote the growth of radio as an art and industry, and to meet the expanding demands of national defense. Several

hundred research experts and engineers will coordinate their efforts to create new products and services, and improve existing ones, in all fields of radio and electronics.

The march of progress which has led to Princeton started back in 1919 when the first RCA laboratory was located in a tent, later to be augmented by a shack 15 feet square at Riverhead, L. I. From

that humble beginning, with public service as the watchword, RCA has pioneered in radio manufacturing, international communications, marine radio, broadcasting, sound reproduction and television. Through continuous research it has discovered keys that have unlocked new doors of radio science, and has extended the usefulness of radio into many realms of public service.

Now, RCA research experts on a united front at Princeton are to take another historic step to enhance America's preeminence in radio, and to increase the services of radio to the Government, to the people of the United States and to industry.



RCA LABORATORIES

A SERVICE OF RADIO CORPORATION OF AMERICA
Radio City, New York

RCA Manufacturing Co., Inc. • Radiomarine Corporation of America
RCA Laboratories • National Broadcasting Company, Inc.
R.C.A. Communications, Inc. • RCA Institutes, Inc.



J. E. Smith, Pres.
National Radio
Institute
Est. 25 Years

I WILL TRAIN YOU TO START A SPARE TIME OR FULL TIME RADIO SERVICE BUSINESS WITHOUT CAPITAL

**N.R.I. MEN
WORK IN THESE
BRANCHES, TOO**

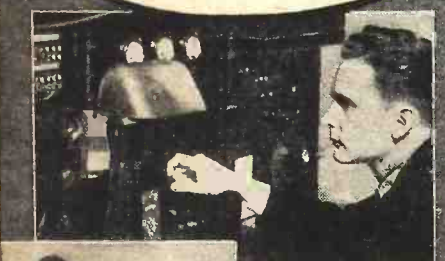

(Above) Broadcasting Stations employ operators, installation, maintenance men and Radio Technicians in other capacities and pay well.



(Above) Radio Jobbers and Dealers employ installation and service men at good pay.



(Above) Loud Speaker System is another field for Radio Technicians.

(Left) Police, Aviation and Commercial Radio are newer fields for which we give the required knowledge of Radio.

DRAFT REGISTRANTS!

Hundreds of men who know Radio when they enter military service are going to win specialist ratings in the Army, Navy and Marine Corps. These ratings pay up to 6 times a private's or seaman's base pay, in addition to carrying extra rank and prestige! If you ARE NOT called, you are getting into Radio when the Government is pouring millions into the Radio industry to buy Defense equipment, on top of boom civilian Radio business. Whether you enlist or wait for conscription—**IT'S SMART TO LEARN RADIO—NOW!**

SAMPLE LESSON FREE

I want to prove our Course gives practical, money-making information, that it is easy to understand—what you need to master Radio. My sample lesson text, "Radio Receiver Troubles—Their Cause and Remedy," covers a long list of Radio receiver troubles in A.C., D.C., battery, universal, auto, T.R.F., superheterodyne, all-wave, and other types of sets. And a cross reference system gives you the probable cause and a quick way to locate and remedy these set troubles. A special section is devoted to receiver check-up, alignment, balancing, neutralizing, testing.

You can get this lesson Free by mailing the coupon.

Mail Now

I Trained These Men

These Men Have SPARE TIME BUSINESSES



"I repaired many Radio sets when I was on my tenth lesson. I really don't see how you can give so much for such a small amount of money. I made \$600 a year and a half, and I have made an average of \$10 to \$20 a week—just spare time."
JOHN JERRY
1529 Arapahoe St., Room 17, Denver, Colo.

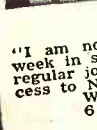

"I am now making from \$10 to \$25 a week in spare time while still holding my regular job as a machinist. I owe my success to N.R.I."
WM. F. RUPP
611 Green Street, Bridgeport, Pa.



"I am doing spare time Radio work, and I am averaging from \$700 to \$850 a year. Those extra dollars mean so much—the difference between just barely getting by and living comfortably."
JOHN WASHKO, Hazleton, Penna.
97 New Cranberry.

I Trained These Men

These Men Have FULL TIME BUSINESSES



"For the last two years I have been in business for myself making between \$200 to \$300 a month. Business has steadily increased. I have N.R.I. to thank for my start in this field."
ARLIE J. FROEHNER
300 W. Texas Ave., Goose Creek, Texas

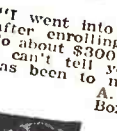

"I went into business for myself 6 months after enrolling. In my Radio repair shop I do about \$300.00 worth of business a month. I can't tell you how valuable your Course has been to me."
A. J. BATEN,
Box 1168, Gladewater, Texas



"I am making between \$50 and \$60 a week after all expenses are paid, and I am getting all the Radio work I can take care of. Thanks to N.R.I."
H. W. SPANGLER,
126 1/2 S. Gay St., Knoxville, Tenn.

The world-wide use of Radio has made many opportunities to have a spare time or full time Radio service business of your own. Over 28,000,000 homes have over 40,000,000 Radios. There are more Radios than telephones. Every year millions of these Radios go out of date and are replaced. There's an opportunity to earn good commissions selling new sets. Millions more need new tubes, servicing. I will train you at home in your spare time to sell, install, fix all types of Radios; to start your own Radio service business and build it up on money you make in your spare time while learning. You don't have to give up your present job, or spend a lot of money going away to school to become a Radio Technician.

Beginners Quickly Learn to Earn \$5 to \$10 a Week Extra in Spare Time

I start sending Extra Money Job Sheets the day a student enrolls—start showing how to do Radio repair jobs. Throughout the Course I send additional plans and directions for doing increasingly complicated, better paying jobs. That's why many students make \$5 to \$10 a week extra in spare time; why many start building their own Radio service businesses while learning.

I Train You for Good Jobs Too Many Pay \$30, \$40, \$50 a Week

Anyone can tune a Radio set, but few can service one. That's why many qualified Radio Technicians make such good money installing, fixing, selling home and auto Radio Sets, operating and maintaining Broadcast, Police, Aviation, Commercial Radio stations; selling, installing, servicing

Loudspeaker systems. That's why many open their own Radio sales and repair businesses and make \$30, \$40, \$50 a week. Why others hold their regular jobs and make \$5 to \$10 a week extra fixing Radios in spare time.

How I Give You Practical Experience

I send you special Radio equipment; show you how to conduct experiments, build circuits illustrating important principles used in modern Radio receivers, broadcast stations and loudspeaker installations. You work out, with your own hands, many of the principles you study in our lesson texts. **YOU ALSO GET A PROFESSIONAL ALL-WAVE, SET SERVICING INSTRUMENT.**

You Learn Television, "F-M", Electronics

The N. R. I. Course is up-to-date. You are taught how to install, adjust, service Television receivers and antennas. You learn about Frequency Modulation transmitters and receivers; you learn the principles of electronic control equipment, such as photoelectric counters, safety devices, electric eye burglar alarms, etc.

Find Out How I Train You at Home

Act Today. Mail the coupon now and I will send my book, "Rich Rewards in Radio," and a Sample Lesson free. Find out what Radio offers; what opportunities are coming in Television. Read the details of my Course in Radio and Television; read more than 100 letters from men I have trained; what they are doing earning. Read my Money Back Agreement. MAIL COUPON BELOW in an envelope or paste on a postcard—NOW.

**J. E. SMITH, President
National Radio Institute, Dept. 1GX
Washington, D. C.**

GOOD FOR BOTH 64 PAGE BOOK **FREE** SAMPLE LESSON

**J. E. SMITH, President, National Radio Institute
Dept. 1GX, Washington, D. C.**

Without obligating me, mail your Sample Lesson and 64-page Book FREE. I am particularly interested in the branch of Radio checked below. (No salesman will call. Write plainly.)

- Radio Service Business Of My Own
- Service Technician for Radio Stores and Factories
- Spare Time Radio Servicing
- Auto Radio Technician
- Aviation Radio
- Operating Broadcasting Stations
- Army, Navy Radio Jobs
- Operating Police Radio Stations
- Operating Ship and Harbor Radio

(If you have not decided which branch you prefer—mail coupon for facts to help you decide.)

Name

Address

City State Age



RADIO-CRAFT

HUGO GERNSBACK, *Editor-in-Chief*

N. H. LESSEM
Associate Editor

THOS. D. PENTZ
Art Director

R. D. WASHBURNE, *Managing Editor*

IN THE NEXT ISSUE!

- Money-Making with Wireless Phono-Oscillators
- Frequency Modulation Phono Pickup
- Voltage Multiplier-Type Power Supply and Amplifier
- Making an Inexpensive Vacuum-Tube Volt-meter
- Combining High- and Low-Frequency Loud-speakers

Contents JULY, 1941 Issue

VOLUME XIII -- NUMBER 1

Mailbag	3
Editorial: War Radio Weapon	Hugo Gernsback 9
Radio Month in Review	10

SERVICING

New Circuits in Modern Radio Receivers—No. 46	F. L. Sprayberry 12
Operating Notes	13
The Latest Developments in 1941 Auto-Radio Circuits	Bob Stang 14
Interference in Loop Circuits	Willard Moody 16
Dynamic Testing with Your Signal Generator ..	Herbert S. Haynes 18
RADIO SERVICE DATA SHEETS:	
No. 310—Zenith Model 4K600 "Poketradio" (chassis 4B01)	20
No. 311—Crosley Model 45BV "Commuter"	21
Radio Repair—China Style	Fred Shunaman 22
Eliminating Ignition Interference in Car-Radio Installations....	24

F. M.

An Engineer Analyzes the How and Why of Frequency Modulation—Part I	Raymond F. Guy 25
---	-------------------

SOUND

Sound Engineering—No. 19	Conducted by A. C. Shaney 28
How to Build a Modern 30/15 Watt P.A. - Radio - Recording Console—Part II	R. J. Bergemann 34

ELECTRONICS

24 Recent Radio Tubes	R. D. Washburne 38
-----------------------------	--------------------

RADIO SHOW REVIEW

Review—Radio Parts National Trade Show	44
--	----

RADIO DEFENSE

Our Ailing Radio Defense Program	Leo Fenway 48
--	---------------

ENGINEERING

Rejuvenating Dry Batteries!	Benj. S. Vilkomerson 51
-----------------------------------	-------------------------

RADIO DEVELOPMENTS

How the Radio Industry Has Grown	54
Modern Miniature Portables.....	N. H. Lessem 55

DEPARTMENTS, ETC.

Mailbag	1
The Radio Month in Review	10
New Circuits in Modern Radio Receivers—No. 46	F. L. Sprayberry 12
Operating Notes	13
RADIO SERVICE DATA SHEETS (See Servicing)	20, 21
Sound Engineering—No. 19.....	Conducted by A. C. Shaney 28
Latest Radio Apparatus	57
Classified Radio Directory—Section IV (Revised)	59
Book Reviews	31, 37



Published by Radcraft Publications, Inc. Publication office: 29 Worthington Street, Springfield, Mass. Editorial and Advertising Offices: 20 Vesey Street, New York City. Chicago Advertising Office: RADIO-CRAFT, 520 North Michigan Avenue, Chicago, Ill.

RADIO-CRAFT is published monthly, on the first of the month preceding that of date; subscription price is \$2.50 per year in U. S. (In foreign countries, 75c additional per year to cover postage; Canada, 50c additional.) Entered at the post office at Springfield as second-class matter under the act of March 3, 1879. All communications about subscriptions should be addressed to: Director of Circulation, 20 Vesey Street, New York, N. Y.



Foreign Agents:

London—Gorrings's American News Agency, 9A Green St., Leicester Square, W. C. 2, England.
 Paris—Messageries Dawson, 4 Rue Faubourg, Poissonniere, France.
 Melbourne—McGill's Agency, 179 Elizabeth St., Australia.
 Dunedin—James Johnston, Ltd., New Zealand.



Text and illustrations of this magazine are copyright and must not be reproduced without permission of the copyright owners.



Copyright 1941 Radcraft Publications, Inc.

THE COUNTRY SERVICEMAN

Dear Editor:

I am enclosing a few "Operating Notes" (Thank you!—Ed.) that I believe might be helpful to those who have not had experience with these models. I know most of these cases bothered me the first time I encountered them—back when I was just beginning. I'm an old-timer now—3 years of servicing and set-building, and every month since I enrolled in a correspondence school, I have read and enjoyed *Radio-Craft*. I like the modernistic binding and layout—I think practically every change you have made in the magazine has been for the better.

The get-together pages, where readers meet and express their opinions, also appeal to me. I read them the first thing, and keep thinking that I will find time to write and express some of my views. But it seems like every time I get the typewriter out and the salutation pecked out someone comes in with a radio set and a carload of batteries, and by the time I get them all inside and hooked up, poor old Mr. Typewriter has found himself high on a dusty shelf.

The problems of the Country Serviceman sound absurd to the big city shops, no doubt. But our services are essential, just as theirs are.

For instance, Mr. Bung, a good honest farmer, has a console that only a trucking company would attempt to move, yet he must have something done to it, because it sounds like an electrical blitzkrieg when he tries to get his daily news about the original blitzkriegs. He goes to the city shop about 35 miles away, and they quote him a price for coming and getting his chassis and returning it to their shop. They don't know what the actual repair would cost, since they haven't seen the set. Mr. Bung does a little rapid calculation—if they live real thrifty, and he takes good care of his shoes, perhaps by dividing the repair cost in two payments, it can be paid out of this year's calf crop and next spring's potato venture. But on the way home he meets an old friend who tells him about the radio repairman in the little town of Black-out, just across the hills, who has a reputation for doing good work at less cost to Mr. Bung. So Mr. Bung goes to see him.

Then the old Country Serviceman grabs his hat, his condenser kit, his resistor box, a few portable testers, and a set of tubes for Mr. Bung's radio. (Mr. Country Serviceman makes it his business to have a record of all the "radios" in his territory, thus knowing what tubes to take.) Then he "burns dust" to Mr. Bung's house.

Mr. Bung's wife and 12 or more kids gather around to witness the unveiling of the internal organs of their pride and joy—the best radio in the county, as far as that "little" family is concerned. With 3 grown boys peering over one shoulder, a teen-age girl and an infant over the other, a bushy-headed boy under each arm, the wife standing in such a position as to cut off all light from the window, and the window itself filled with the faces of those on the outside who either did not have the nerve to come in, or feared there wasn't room, the radio doctor sits down to diagnose and operate.

It is queer that practically all those who do not know anything about radio, think a radio man can tell by listening to a set, or by glancing at the dial, what the trouble is. They seem disappointed if you can't put your finger on the defective part in 30 seconds. They have the idea that you can connect a set tester to a set, and just one glance will tell you how the tubes are, and

everything else you need to know. Honestly, you'd be surprised to know how many people do not know about the condensers, resistors, and wiring below the chassis. It is a fact that many people think all there is to a set are the tubes, coils, etc., visible above the chassis. So usually the family is stricken with amazement when Mr. Country Serviceman turns the chassis upside down and exposes all those firecrackers and tiny shotgun shells, imbedded in a crow's nest. The same remarks are made by every family that is astonished: "How in the world can you tell anything about that mess?"

Mr. Country Serviceman takes one listen and knows what is wrong. There is terrible distortion mixed with motorboating and a weird sort of howling. Nothing but a filter condenser. Not even a bad tube or a run-down battery. When test leads from a neat "condenser substitution box" are placed across the high voltage, the signal generator tone clears up—thus making the simplest test in radio look like a miracle of science.

Mr. Bung is amazed when you tell him he owes you only \$3. He makes a verbal promise right then that never again shall anyone but Mr. Country Serviceman piddle with his set. And within a week, 3 or 4 ailing sets of his neighbors are "surrendered for service."

Well, good luck to *Radio-Craft*—and keep up the good work.

NORRIS CHAMBERS,
Cross Cut, Texas.

Mr. Chambers' colorful description of "service in the sticks" may induce some other erstwhile backwoods radioman to speak his piece. How about it? Come on, don't be bashful!—Editor

"ELECTRONIC ORGAN"

Dear Editor:

In your April, 1941, issue appears an article by W. K. Allan on an "Electronic Organ," and credit is given there to the undersigned for suggesting a marking tool in locating the reed tongue position.

The real credit belongs to Mr. Victor R. Mumma for first constructing this tool and due to an oversight of the publisher of the source article (*Electronics*, April, 1940 "Design for an Electronic Reed Organ") acknowledgments (including that to Meissner Inventions, Inc.) were omitted.

F. D. MERRILL, JR.,
Millburn, N. J.

We are always glad to give space to information which helps to "keep the record straight."—Editor

PRACTICAL SIGNAL TRACER

Dear Reader:

We know from the correspondence that daily surges back and forth over our desk, that the following 2-way confab will be of considerable general interest.

To Mr. Monroe M. Freedman:

I have sent this letter to *Radio-Craft* to be addressed to you—(thanks to them).

Mr. Freedman, I am building one of your "Practical Signal Tracers" described in *Radio-Craft*, Sept. 1940. I do like your circuit and want to congratulate you . . . it's tops.

At your convenience, please advise me on the right "B+" Voltage. My transformer (from an old set) is putting 400 volts at the input filter and 315 volts on the 6F6 plate.

Am using 200-ohm choke and substituting a 600-ohm choke and a 650-ohm resistor for the field (using an 8-inch P.M. speaker).



LET THE HIGH LINES
MAKE PROFITS FOR YOU!

SELL GTC
PORTA-POWER
CONVERTS BATTERY OPERATED
RADIOS TO ALL-ELECTRIC

MODEL "P"
For 6 volt radios
"Twin-Powered"

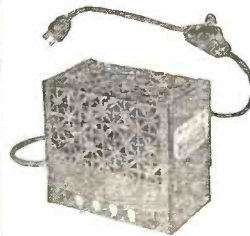

Converts 98% of all 6 volt radios. Vibrator disturbance is eliminated. High fidelity performance assured. List price \$13.95.

MODEL "L"
For 2 volt radios

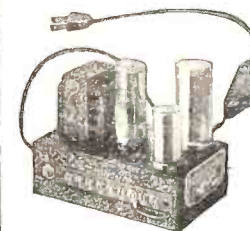

Supplies "A", "B" and "C" power to 4 to 8 tube battery-operated radios using 2 volt tubes. List price \$9.95.

MODEL "U"
For 1 1/2 volt portable
or farm radios



Powers any portable or battery radio using 1 1/2 volt tubes. Provides "A" and "B" power. List price \$7.50.

MODEL "G"
For 1 1/2 volt radios
of 4, 5, or 6 tubes

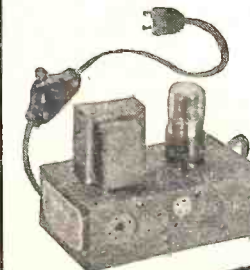

For 1 1/2 volt radios of 4, 5, or 6 tubes requiring more power than Model "U" provides. List price \$9.50.

When you reset radios with push-button tuning be sure to mention GTC Porta-Power for electrifying Portable and Rural Battery Radios.

GENERAL TRANSFORMER CORP.
1254 W. VAN BUREN ST. • CHICAGO, ILLINOIS

RADIO TRAINING



Founded in 1909

PORT ARTHUR COLLEGE, a non-profit making educational institution, offers a practical radio operator's course at the lowest tuition price in its history. Each radio graduate receives two months' actual operating experience at the college's commercial broadcasting station KPAC. This station is equipped with the latest type 1000 watt high fidelity RCA transmitter—1250 kc.—directional antenna system. KPAC operates in new modern studios located on the campus.

The college has never advertised jobs or positions in lieu of education. Today it is well known there is a shortage of radio operators in every branch of radio; therefore, we believe it is good common sense to mention that Port Arthur College is the sole radio school in America which owns a commercial broadcasting station with commercial advertising representatives in New York, Chicago, San Francisco, and many of America's leading cities, with active membership in the National Association of Broadcasters, and Broadcast Music Incorporated. Through these contacts the college receives from the broadcast industry alone a great many more calls for student radio operators than it is possible to supply. Authorized to teach RCA texts.

If interested, write for Bulletin R-41

PORT ARTHUR COLLEGE
PORT ARTHUR (World-Known Port)
TEXAS

BRAND INVALUABLE!
NEW!

ONLY **25¢** a copy



The greatest, most compact formula book in print. Contains actually 1000 trade secrets, recipes and processes for home, factory and workshop.

Check-full of money-making ideas. Has newest tried and tested formulas for making Glues, Cements and Adhesives; Cleaning Compounds; Paint and Pigments; Wood Stains; Var-nishes; Disinfectants and Deodorants; Fire Proofing and Extinguishers; Glass working; Inks; Insecticides; Laundry Processes; Metal Work; Etching Fluids; Solders;

Paper Making; Photographic Processes; Preserving Essences; Extracts and Flavors; Plastics; Plating Solutions; Polishes; Preservatives; Fireworks; Soaps; Creams; Dyes; Toilet Preparations, Dentifrices and Cosmetics; Hair Preparations; Manicure Preparations; Sun Burn Creams and Lotions; Waterproofing; Waxes and countless others.

A Wonder Book of Useful Knowledge! Worth its weight in gold. Book is up-to-date. Newest methods—latest discoveries. Remember—1000 clearly described SIMPLIFIED formulas, processes and recipes—MANY NEVER BEFORE DISCLOSED.

68 pages, printed on good paper. Send for your copy TODAY. Remember, great fortunes are made from formulas.

25¢ a copy, sent **postpaid** anywhere. Send money order, check, unused U.S. stamps or coin.

NATIONAL PLANS INSTITUTE
246-R Fifth Avenue New York, N. Y.

FLUORESCENT

Buy Direct—All Types—Factory Prices

Save up to 50% on Fluorescent Lighting. Using 100% G-E parts. Dealers—write for FREE catalog.

McGEE RADIO, F-2053, KANSAS CITY, MO.

Would you suggest a resistor in series with each plate of the 80 tube or add proper resistance after the first choke (your 200-ohm)?

R. H. TURNER,
St. Louis, Mo.

Dear Mr. Turner:

I would suggest using 250 volts on the plate of the 6F6.

The best way to determine the exact-size resistance in the filter circuit is to determine the total current drawn by the plates and screen-grids of the tubes in your tracer. The easiest way to do this is to put a milliammeter in the negative return.

After noting the current drain, and you know you want to drop 65 volts:

$$315 \text{ V.} - 250 \text{ V.} = 65 \text{ V.}$$

you merely calculate via Ohm's Law:

$$E \text{ (in volts)}$$

$$R -$$

$$I \text{ (in amperes)}$$

This will give you the additional size of resistance you would have to add in your filter circuit.

I suggest using filter chokes having the resistance equal to

$$200 + 600 + 650 + \text{calculated value}$$

Say the additional resistance is 1,000 ohms; then your total filter circuit R should be equal to 2,450 ohms. I would then suggest 2 chokes having about 1,200 ohms each, instead of using resistors.

Further, I suggest the following changes:

1. Substitute 5,000- to 10,000-ohm resistors in the plate circuits of the 6K7 tubes.

2. Substitute 60,000-ohm resistors for the 25,000-ohm screen-grid resistors (2 watt), (see Fig. 2).

3. The "eye" circuit in the schematic is incorrect. The "B+" goes to the target, not to the plate, of the 6E5.

4. I suggest making the audio section first, then add the divider section, the 6K6 (2nd R.F.), and finally the 6K7 (1st R.F.).

5. Watch the grid leads around the 1st (6K7) R.F. Shield them or you'll run into oscillation trouble.

6. Make sure the 1st 6K7 is not microphonic.

7. Finally, I suggest using single-ended tubes like the 6SK7 and 6SQ7.

M. FREEDMAN,
New York City, N. Y.

RE: ALIGNING SUPERHETS.

Dear Editor:

A letter by Willard Moody in the May issue of *Radio-Craft* indicated that a radio tube between a point of contact and a tuned circuit would isolate that circuit from whatever was connected to the tube. To quote Mr. Moody directly, "the circuits being aligned are separated from the generator by the tube, a 6SK7, which stands between the generator and a 6SQ7."

Now, not wishing to raise any additional arguments on the subject of Mr. Buck's alignment method—I think we've had enough of these already—I have had some interesting experience along this line, some that should prove helpful to many radio men.

Having designed signal tracers and methods of using them, I spent considerable time experimenting with systems that would speed up service work and make the job easier.

The experience referred-to came while I was attempting to devise a system of aligning a radio set with a signal tracer and without an oscillator. At first it was my idea to tune the signal tracer to the I.F. of the set, pick up the signal at the 2nd-detector and align the I.F.s for maximum

reading on the signal tracer's indicator. Some of the manufacturers recommended this system, but apparently never tried it. The first thing wrong with it is that perhaps the I.F. being passed along the I.F. circuits, is a signal strong enough to override the tuned circuits of the signal tracer, thereby giving a peak on a signal that is of a frequency between that to which the I.F.s are tuned and the setting of the signal tracer.

To eliminate this possibility, I jumped the signal tracer probe back to the plate of the converter tube and thought I would adjust the I.F. by turning the dial until I had a signal that was the true I.F. However, I found that even though I had a coupling condenser of only 1.5 mmf. I still detuned the oscillator circuit noticeably! In other words, the interelement capacity of the tube was not sufficient to prevent the detuning of the oscillator section.

Now, everyone knows that oscillators are screwy and delicate things and subject to all kinds of unusual responses. So, thinking as Mr. Moody said that a tube would isolate the signal tracer from the tuned circuit, I decided that I should be able to pick up enough R.F. on the plate of the 1st audio to work my meter and permit alignment. I was somewhat surprised to find that the detuning effect with the signal tracer probe, a 1.5 mmf. condenser, on the 1st audio plate was apparently as great as when the diode was contacted directly! I next jumped to the plate of the output tube and found that the signal tracer *still detuned the last I.F.!* (All the wise guys who think there is no R.F. available on the plate of the output tube despite the bypass condensers: just take a signal tracer and try for yourselves.)

Becoming immensely interested at this point, I tried both other "radios" and signal tracers. I found the same results with all signal tracers, but a varying amount of detuning with different radio receivers. I also found that by holding the probe 2 or 3 inches from the 2nd-det. and attempting to align the last I.F. still caused objectionable detuning on critical sets. In this position the signal tracer could not have been coupled to the circuit by more than a fraction of an mmf., a figure approaching the inter-electrode capacity of a vacuum-tube.

I think these experiments prove conclusively that a vacuum-tube positively will not isolate a tuned circuit, and for this reason, care should be exercised in installing bypass condensers even on the plates of the audio tubes. If such condensers are not the recommended values, alignment may be found necessary, especially of the last I.F. transformer.

Having brought up the question of aligning with a signal tracer, I believe the additional space required to explain the system I finally did arrive at, will be worth while.

First, I found that when probing in tuned circuits, resistance coupling is far better than a capacity coupling, even the highly touted 1.5 mmf. used by many signal tracer manufacturers. In fact, 1 meg., while causing considerable signal loss, seldom, if ever, detunes a circuit. A 100,000-ohm resistor was found to cause less signal drop, and less detuning, than the 1.5 mmf. condenser.

It was also found that on sets having split diodes, i.e., one diode furnishing the audio component and the other the A.V.C., contact could be made at the latter, and the last I.F. adjusted, without noticeable detuning. This again proves that resistors are better de-couplers than condensers, because the A.V.C. network is isolated from the tuned circuit by resistors.

Accordingly, using a 100,000-ohm resistor as a coupler, I contacted the 2nd-detector

with my signal tracer set to the I.F. I rocked the signal tracer back and forth through the signal, at the same time changing the tuning-dial setting of the radio set until I was sure that the proper I.F. was being generated. (It is absolutely necessary that a weak, out-of-town station be used for this purpose.) I then peaked the I.F.s, removed the probe from the 2nd-detector and re-touched the trimmers, picking-up an audio signal from the audio section through a 1-meg. probe as an indicator.

I still do not recommend this method over that of a good oscillator. However, satisfactory results can be obtained. And, when using an oscillator, I do recommend that it be resistance-coupled to the set, instead of capacity-coupled, for less detuning effect. Personally, I connect my oscillator to the antenna and ground connection of my radio receiver and never move it. I force the I.F. signal through the R.F. section*, which system I believe causes less detuning than connecting to the grid of the converter or 1st-detector. My final adjustments of oscillator trimmer and padder as well as R.F. trimmers is always made by using a weak out-of-town signal from a broadcasting station. (I refer to broadcast-band adjustments.) Such is not always possible on shortwave.

I hope that this will shed some light on the much discussed subject of "mis-alignment."

HAROLD DAVIS,
Jackson, Miss.

*It is a good idea to stop the set oscillator by shorting the oscillator section of the tuning condenser.

SERVICING OBSERVATIONS

Dear Editor:

Your magazine, which I buy from the newsstand, certainly "comes in on the button."

I've repaired sick radio sets since I built my own 1-tube regenerative way back when a WD12 cost \$6. I haven't become at all wealthy but I have earned a good deal. Radio repair work still has its attraction for me and with its constant changes it offers many new problems to be solved. A few things I have learned about radio receivers might be of help to some budding Serviceman.

- (1) The human eye cannot see an electrical connection.
- (2) Always test tubes even if they are supposed to be all right. Take plenty of time in testing them—be very thorough.
- (3) Faulty internal connections in mica and paper condensers, resin joints, and joints soldered while under tension cause many puzzling cases of noise and intermittent operation.
- (4) Use the correct meter scale. Use the low-range ohm scale for coils and low-volt range for low voltage, etc. The vacuum-tube voltmeter should be used today, more than ever.
- (5) Most cases of pronounced distortion call for inspection of detector circuits. Audio circuits come 2nd, with I.F. and R.F. 3rd. Most speaker troubles are rattles.
- (6) Oscillation, today, is generally caused by defective electrolytic condensers. Next in order are defective paper condensers, lack of grounds to shielding and improper dressing of leads. An uncommon cause, but a very annoying one, is the case of tube types being changed. Sometimes a change from metal to glass tubes, or vice versa, will cause circuit oscillation.
- (7) Some of the most difficult cases of noise in car-radio sets I have solved by

more accurate aligning and peaking of I.F. circuits. One very baffling case of vibrator noise was solved by replacing a defective output tube.

(8) A Serviceman should always make certain that a receiver is "all there." Many times a customer takes shields off and forgets to replace them. Sometimes they put the shields on the wrong tubes. Such changes cause many circuit disturbances. They may cause oscillation, weak reception, distortion or combinations of faults.

I can recommend only the best equipment that one can afford. Inferior equipment will always let a Serviceman down sooner or later. A Serviceman should always keep up-to-date in his work by studying books and magazines devoted to radio subjects.

One subject that greatly interests me is the lightbeam transmission of voice. In fact I enjoy studying any of the uses of the electric eye. I hope *Radio-Craft* will tell us more about it. Your efforts in behalf of National Defense are truly American.

GEORGE BATCHELDER,
Woodsville, N. H.

We will continue to publish articles for experimenters, in addition to the large amount of material we regularly carry for Servicemen and sound specialists, as it is to this group we must look for the new developments in days to come. Hence any assistance we may give them, however slight, toward broadening their knowledge, may one day return as some new idea in the field—electronics especially.—*Editor*

MR. SHANEY'S ARTICLE IN "R.-C."

Dear Editor:

Just finished reading the "Mailbag" in your May issue of "R.-C.," and like it very much. It gives all the readers who care to, a chance to express their own particular opinion concerning their pet peeves. I, too, have an opinion to express, therefore my reason for writing you.

I admire Mr. A. C. Shaney very much and take this opportunity to thank "R.-C." for publishing all of Mr. Shaney's articles on Sound and its associated applications. I would also like to take the liberty of thanking Mr. Shaney himself for his unflinching devotion to all your readers by his submitting of Sound articles to *Radio-Craft*.

While reading the "Mailbag" I came across a letter written by a Mr. Ellsworth Dodrill of O'Neill, Nebraska, wherein he criticizes *Radio-Craft* and Mr. Shaney for being accomplices in a little advertising deal more or less, concerning the Amplifier Co. of America. Please refer to Mr. Dodrill's letter.

I, too, have constructed a goodly number of Receivers, P.A. Systems, etc., that have appeared from time to time in "R.-C." Although not being a subscriber to your publication I feel that I have a little right to express my opinion, also.

After having read Mr. Dodrill's letter, there is no doubt whatsoever in my mind that he is in a way disgusted, as he says with your section on amplifiers, disgusted, mind you, not only with *Radio-Craft*, but with Mr. Shaney and his company also. He goes farther in his letter, by stating that, after getting all enthused over a particular amplifier and all its good qualities, it finally ends up with sort of a basic parts list or none at all. Then on top of that he relates that in reality it is just another plug for the Amplifier Co. of America. I

*May, 1941, issue.

New Direct-Coupled FM - AM AMPLIFIER MANUAL

By A. C. SHANEY

Chief Engineer, Amplifier Co. of America

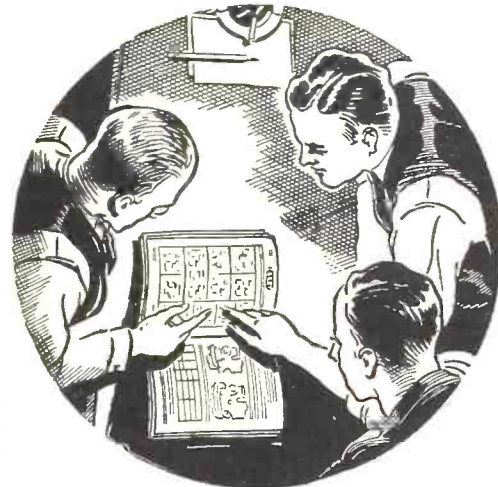

For the Layman, Serviceman Recordist and Engineer

Regardless of whether you are interested in the finest type of phonograph reproduction, high fidelity recording, sound-on-film applications, FM or AM programs, you will find invaluable information in this practical handbook. Written by the leading exponent of direct-coupled amplifiers who has spent more than 10 years improving and perfecting the famous Loftin-White circuit.

Explains the theory and practical application of:

- Variable Speed Non-Overloading Push-Pull Expansion
- Non-Frequency Discriminating Scratch Suppression
- Push-Pull Balanced Direct-Coupled Amplification
- Push-Pull High-Frequency Equalization
- Push-Pull Low-Frequency Equalization
- Push-Pull Volume Compression
- Automatic Volume Limitation
- Automatic Volume Control
- Calibrated V.U. Indicator
- Audio Spectrum Control
- Remote Control

If you are interested in the latest audio developments, you can't afford to be without this complete compilation of authentic articles on Direct-Coupled Amplifiers. 32 pages 8½" x 11". Over 100 diagrams and illustrations.

Priced to Cover Cost of 20c
Printing and Mailing

Send Stamps or Coin

AMPLIFIER CO. of AMERICA
17 WEST 20TH STREET. NEW YORK, N. Y.



LEARN
RADIO
SERVICING COURSE - 8 WEEKS
OPERATING COURSE - 5 MONTHS

H. C. Lewis I'LL FINANCE YOUR TRAINING

Mail coupon today for free book showing how you can learn Radio Operating, Servicing, Sound and Television in a few short weeks in Coyne Shops and also how you can pay tuition in easy monthly payments after graduation.

LEARN BY DOING
On real Radio receiving and transmitting equipment at Coyne. Simple, easy method of practical shop training. You don't need previous experience. Prepare for Radio Operators' Government license Exam. and for good jobs in Broadcast, Police Radio, Aircraft Radio, Ships, Commercial Radio stations, or in service shops and radio factories. "Learn by doing", the quick, modern way, at Coyne Shops in Chicago.

EARN WHILE LEARNING
We assist you in getting part-time work to help pay living expenses and give you real employment service after you graduate. Mail coupon now for all details of my plans to help you.

H. C. LEWIS, Pres., COYNE ELECTRICAL SCHOOL (Radio) Div.
500 So. Paulina St., Dept. 81-8H, Chicago, Ill.
Please send me your free book and details of easy Pay-After-Graduation Plan.

NAME _____
ADDRESS _____
CITY _____ STATE _____



SEND
COUPON
TODAY

DATAPRINTS

TESLA-LOUDIN COILS

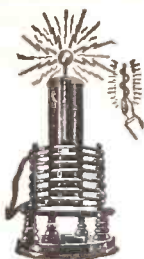

- 20c Ea. in order for 10 (Data and Drawings only.)
- 36" Sp'k Tesla-Oudin Coil 40c (1 K.W. Exc. Trf. Data incl.)
- 8" Sp'k Tesla-Oudin Coil 40c (1/4 K.W. Exc. Trf. Data incl.)
- 3" Sp'k Oudin; 110 Vt.
- "Kick Coil" type.....40c
- 3" Tesla Works on Ford Coil.....40c
- 1" Sp'k Vibrator Hi-Freq. Coil 40c

NEW! 5 ft. Sp'k. Oudin Coil & Exciter Data75c



Induction PIPE & ORE LOCATOR

Induction Type, Data40c
Radio Type40c

More DATAPRINTS 40c each!

- | | |
|------------------------------|-------------------------|
| 5 Meter Superhet. | Electric Refrigerator |
| 1/2 Meter Tr. & Rec. | Wheatstone Bridge |
| 20 A.C. Probs. & Ans. | Weld. Transf. 2 K.W. |
| 20 Telephone Hook-ups | Rewinding Armatures |
| 100 Mech. Movements | String Galvanometer |
| 20 Motor Hook-ups | 20 Simple Bell Circuits |
| Television Hook-up | Steel Wire Recorder! |
| 20 Elec. Party Tricks | Water Wheels |
| Solenoids and Magnets | Water Turbines |
| —get list. | Photo Cell and Relay |
| Fry Eggs on Ice! | Ring 4 bells: 2 Wires |
| Experimental Photo-
phone | 20 Tesla Tricks |
| Radio Control for
Models | Polarized Relay |
| Diathermy Apparatus | Induction Balance |
| Inductor Organ | Electric Pipe Thawer |

Special Prices: 4 prints \$1.00; 10 for \$2.00;
Single, 40c each. Get New Catalog 100 A.

The DATAPRINT Co.

Lock Box 322D, Ramsey, N. J.

MAKE BIG MONEY AT HOME!

NEW INVENTION
Electroplates by Brush



New, patented invention makes possible big earnings AT HOME. Replate auto-parts—worn articles in homes, stores, hotels, restaurants, etc.—with durable, sparkling, new coat of metal—with stroke of brush. Easy, simple, quick. Genuine Gold, Silver, Nickel, Cadmium, etc. Everything furnished. Outfit complete, ready for use. No shop required. Clear from \$2 to \$5 an hour in lifetime business. Small investment starts you in business. Steady repeat. Machine can pay for itself in week. Send TODAY for FREE SAMPLE and illustrated BOOKLET how you can have a life income from a business of YOUR OWN built upon satisfied customers. Act at once!

WARNER ELECTRIC COMPANY
225 N. Wabash Ave., Chicago, Ill., Dpt. 6-B

FREE
SAMPLE and
BOOKLET
EXPLAINS ALL

COMMERCIAL RADIO INSTITUTE

A radio training center for over twenty years. Well equipped. Excellent faculty. Practical resident courses in Radio Telegraphy, Broadcast, Servicing, Industrial, Television, Aeronautical, Drafting, Mathematics and Studio Technique. Placement Bureau. Catalog upon request.
Dept. D, 38 West Biddle Street, Baltimore, Md.

RADIO COURSES

Start September

- RADIO OPERATING—BROADCASTING
- RADIO SERVICING—a practical course
- RADIO AMATEUR CODE • TELEVISION
- ELECTRONICS—1 yr. day course 2 yrs. eve. Day and Evening Classes. Booklet Upon Request.

New York Y.M.C.A. Schools
4 W. 64th Street New York City



Correspondence Courses in RADIO and ELECTRICAL ENGINEERING

ELECTRICAL ENGINEERING Get good grasp of wide electrical field. Prepare yourself, at Low Cost, for secure future. Modern, simplified, you can understand quickly.
RADIO ENGINEERING Extra fine course in radio, public address, photo-electric work. He address, real vacuum tube technician. Exper. kits furnished. Diploma on completion. Tuition, \$25. either course. Deferred payment plan.
FREE Get copies of school catalogs, student magazines, complete details. SEND NOW!

LINCOLN ENGINEERING SCHOOL, Box 931-C31, LINCOLN NEBR.

would like to dedicate the balance of this letter to Mr. Dodrill himself and I'm sure it will hit the nail right on the head.

Mr. Dodrill, here is some sound advice: If your radio knowledge starts at the parts list in each article you read, you will be doing yourself a great favor, by obtaining a copy of "Rich Rewards in Radio" (or something similar). Then, after having mastered Ohm's Law and the basic principles of radio, try building something without even referring to the parts list. You will find that it's lots of fun and also it will increase by 3-fold your knowledge of radio and all its intricacies.

Getting back to the subject of the Amplifier Co. of America, you will find that in all of Mr. Shaney's articles there is included what is termed a basic parts list. This is usually in the schematic itself. As far as transformers, chokes, filter condensers, etc., are concerned, the proper values for any or all of these units can be found very easily by applying a little of the knowledge that you must have gained in the course of your study of radio.

For instance, if a circuit specified a pair of 6L6 tubes in the output portion operating in class AB2, you wouldn't use an *output transformer* that was designed to match a pair of 6L6 tubes in class A1; also, if a driver transformer appeared in the circuit, coupling a 6F6 tube operating as a triode to the 6L6 tubes in push-pull class AB2, it would only be natural to obtain a transformer designed for this particular application.

Concerning the *power transformer* in any circuit, it is only necessary to figure the combined plate- and screen-grid currents, also the combined filament voltage and the plate voltage, then add an additional 15% for voltage drops, etc. The above can be found by referring to your tube manual. The operating conditions for each tube can be found very easily and the correct potentials applied to the circuit under observation.

If you have any knowledge at all, of the basic principles of radio, you will do well to apply them first, instead of just getting disgusted with everything. In your mind I believe you will agree with me when I say that I do believe you are really disgusted with yourself and not Mr. Shaney and "E.-C." and I believe too, you are ashamed to admit it.

Concerning Mr. Shaney's articles on amplifiers, I feel he is well justified in keeping his parts lists at home where they belong. After all he spends a good deal of time, and gives a lot of thought to all the equipment and subjects he writes on. Precise laboratory instruments aren't very cheap, engineers don't work for nothing and the company has to make money too, to stay in business, and to stay in business they have to sell their merchandise, so why in blazes should they give every Tom, Dick and Harry in the radio profession a schematic and parts list of all the equipment they manufacture? If you were a baker and could make doughnuts better than anyone in the country, and you were profiting by it, would you give everyone interested a recipe so they could make the same doughnuts you were making? Would you?, and sit back and go broke watching them? Like H—you would, so why expect Mr. Shaney to do the same, identical thing?

As it stands I think he has contributed more to the development of Audio Amplification and Sound Engineering principles than anyone since the advent of radio. As far as his circuit diagrams and schematics are concerned, I can say for myself, that they are explicit enough for even a technician of

average ability to decipher. I have built many an amplifier using his circuits as references and have no kick coming, as they all performed according to my expectations. Well, that's my opinion, Mr. Dodrill, and I hope I have made myself clear enough to be understood. In the future take stock of yourself first, before you criticize others.

Thank you Mr. Editor,—and again, thank you, Mr. Shaney, keep on with your Sound articles, I'm for you 100%.

WALTER FERNALD,
Lubbock, Texas.

Take a bow, A.C.S.—Editor

AMERICAN TUBES

Dear Editor:

I have read with interest the letter from Mr. Willard Moody of New York, which is printed in *Radio-Craft* for Jan. 1941.

While I agree with the article generally I feel that I must make some comment on the last paragraph, in which he makes a complaint against American radio tube manufacturers.

I am using in my own radio set an RCA Radiotron 5Z3 as rectifier. This tube was used in a Midwest 16-Tube outfit for more than 2 years and afterwards in my own radio. This tube has been in continuous use for 6-8 hours a day now for nearly 4 years, and is still giving satisfactory results. The other tubes, all of American manufacture, are giving complete satisfaction also.

I can only suggest that perhaps Mr. Moody uses 2nd-grade tubes, or that he does not follow closely enough the manufacturer's instructions regarding voltages to be applied.

The tubes I use are made by RCA, National Union, Sylvania, and Raytheon, and I suggest that Mr. Moody confine his purchases to makes such as these.

I have been a regular reader of *Radio-Craft* for 4 years now.

L. E. J. CLINCH,
Radio Service Engineer,
Bexleyheath, Kent,
England.

MOODY ON THE CARPET

Dear Editor:

I have been a consistent reader of *Radio-Craft* and its predecessors for more years than I like to remember, and have always refrained from writing you, instead I have been content to read those articles and letters I liked and skip the ones I didn't like, but now, I feel that the time has come for me to unload and I find myself utterly at loss for words to express myself.

The particular article, in part, that has raised my DANDER this time is the last paragraph of Moody's letter (pg. 643 May issue), in which he states: "Isn't it plain that the men with the money and ability to buy are going to be the men with education, at least a high school education, and that the others have no place in radio?"

If Mr. Moody is a man with money and ability (which I doubt), why is he flooding every radio publication in the U.S.A., with his numerous varied service notes, articles and letters such as the one referred to above? For recent Moody spasms you don't have to go further than the May issue of *Radio-Craft*. Turn to pg. 684, lower-right-hand column, and you will get some valuable Moody information about a FADA model 5F60-T. Why did Mr. Moody confine this information to the FADA radio when practically all sets that have a bypass condenser from output plate to ground, or plate to screen-grid, have the same symptoms if the condenser opens or comes loose? Why,

if he wanted to give some information, didn't he suggest that this condenser be replaced with one of the same capacity but with a working voltage of 1,000 volts or more, where the manufacturer had installed one ranging from 400 to 600 volts?

Now turn to pg. 688, in the same issue, and look at the wonderful exposé of how Mr. Moody has licked many "posers" in record players. What surprises me most is that "R.-C." will pay for an article like this one. As before stated Moody is really turning out the ideas and almost any magazine that has the remotest connection with radio has carried one or more of his spasms lately.

I am neither a man with money, nor more than a high school education, but when it comes to repairing a radio set I have yet to find one instance where the necessary qualifications to make the repair were more than the ability to see, and to use your hands, coupled with a lot of that education that I am sure Mr. Moody lacks—I mean the kind we learn in the School of Practical Experience. Of course, I do not mean that a man in my class could, nor should he, attempt to design one of the modern and comparatively complicated receivers. That is not the Serviceman's business. But it is his business to keep up with such new circuits after they have been designed in order that he can make necessary repairs if and when called upon to do so.

As above stated, I am not a man with money, but I do own all the equipment in my shop, such as tube testers, analyzers, signal generator, signal tracer and all of the other usual run of tools, etc., and I don't believe that Mr. Moody nor anyone else with a higher technical education than I have can locate a shorted bypass or filter condenser any faster than I can. Will Mr. Moody please explain for the benefit of the many readers of "R.-C.", just how he would use his money and his technical training, if any, to locate an open coupling condenser between the volume control arm and grid of the 1st audio tube as is used in some sets? About 99% of the time this type of trouble is located by SUBSTITUTION, and if that isn't practical experience then I don't know what it is.

My suggestion to Mr. Moody is that he join the I.R.E., or some other organization of highly specialized and rich men, and forget about the suggested R.S.G., as the qualifications are too high and very few of the honest-to-goodness Servicemen of today could meet the requirements, but they can still repair "radios," and other associated equipment.

E. M. PACE,
Pace's Radio Service,
Vicksburg, Miss.

My, my.—Editor

WALKER-BUCK-MOODY

Dear Editor:

Since two of your correspondents (H. C. Buck and Willard Moody.—Ed.) in the April issue are arguing about my old radio at Windsor, Ontario, some information about it may be in order.

It is a "Goldentone D7" of 1936, made (or assembled) in Dearborn, Michigan. It was a very popular type about like diagram No. 4, pg. 180, RCA tube manual of 1937, with added electron-ray indicator, shortwave band, etc. It has 2 standard 456-kc. double-tuned I.F. transformers of unknown make.

It was a good radio set for the money (\$16, mail order); everything was in good adjustment and reception was good all around the dial except for a few images and harmonics, the worst being from the strong

stations 750 and 2414 kc., and on the weak station, 1500 kc.

The 1500-kc. station came in at estimated dial readings of from 1490 in cold weather to 1508 in hot weather. The image of the 2414 Detroit police from 1489 in cold, to 1512 in hot weather.

I'll let them do the figuring and arguing, but these readings give me 457½ to 455 I.F.; or 1/3% off, instead of Mr. Buck's 3% to 20%, or Mr. Moody's 0.0001%. We seem to be talking about 3 different things.

GILBERT S. WALKER,
Pittsburgh, Pa.

Mr. Walker sent a carbon copy of his letter directly to Willard Moody who replied as follows:

Dear Mr. Walker:

Let's forget the whole thing ever started.
WILLARD MOODY,
New York, N. Y.

RE: HEADPHONE CONNECTIONS

Dear Editor:

Just received the first copies of your fine magazine and am very well pleased with it.

There seems to be much difference of opinion, among some of us lads who maintain receivers for use in hospitals and sanatoriums where loudspeakers are not permitted, as to the best method of installing earphones in commercial receivers especially in the late models, some swear by one method, others by a different one, especially in A.C.-D.C. sets.

How about a little discussion on this subject? I am sure that it would be of interest to a great many readers.

C. SEYMOUR,
Newhall, Cal.

See the "Sound Engineering" department in this issue for a discussion of this topic. Anyone else have any suggestions of what they'd like to see in "R.-C."? Step right up! —Editor

"PANAMA" CLARK SAYS:

Dear Editor:

In your section of "Operating Notes," for the month of April, Mr. James Bailie of The Manhattan Radio Service claims that lack of ventilation causes the Emerson U6B to fade.

Would you accept such a theory, Mr. Editor? The fading was caused by a shorted or defective dry electrolytic condenser.

It was this same defect that caused the field coil to become heated and the efficiency of the speaker to be greatly impaired; and by this method used to remedy the defect the receiver will always be a regular visitor to the service shop.

This happens with most A.C./D.C. sets, and several others. The best remedy is to change the shorted condenser, or if one section is bad and cannot be secured, a Solar "Minicap" (Hey!, there, are you a Solar stockholder? Won't any other make do too? Hi!—Ed.) will clear up the trouble.

C. E. CLARKE,
Clarke's Radio and Elec. Service,
Panama, R. P.

F.M. PHONO-PICKUP!

Yes, a real F.M. phono pickup which translates recordings directly into frequency-modulated electrical impulses with amazing fidelity. Read full details in next month's *Radio-Craft*.

Reserve your AUGUST ISSUE Now.



Learn RADIO SERVICE WORK with these 2 BIG Ghinardi BOOKS

MODERN Radio SERVICING

Learn How with this!

Here's the world's most highly praised course in practical radio service work—all for you in this one handsome 1300-page home-study book. First, a big 420-page section explains all types of servicing test instruments—how they work, how to use them—also, how to build your own. Then, 900 more pages give you a thorough, step-by-step procedure course in trouble-shooting, testing, aligning and repairing all makes of radio sets and other electronic devices by latest scientific "factory methods." Learn radio servicing this quick, easy, economical way. Learn WHAT to do and HOW to do it. Send for your copy today. Use the coupon below!

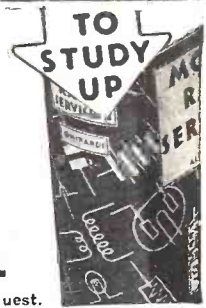

1300 pp., 708 illus., 720 review quest. \$4

RADIO Trouble-Shooter's HANDBOOK

Save Time with this!

Here's real help for servicemen—518 big manual-size pages of valuable, time-saving, factory-checked servicing data right at your fingertips to help you do every servicing job quickly and accurately. Its 52 BIG SECTIONS contain 275 large pages of time-saving "Case Histories" on over 3,300 receivers. Alignment data for over 15,000 superhets. Servicing and installation data for all Auto Radios. Trouble-Shooting Charts. Tube, Resistor and Condenser Charts. EVERYTHING! Speed up your service work with all the vital servicing data NOW in this one big book.



518 pp., 134 illus., 8½x11 size. \$3

CLIP OUT! MAIL NOW!

Radio & Tech. Publ. Co., Dept. RC-71
45 Astor Pl., New York
Enclosed find payment for:
 MODERN RADIO SERVICING RADIO TROUBLE-SHOOTER'S HANDBOOK BOTH books at \$6.50 Money-Saving Combination Price

NAME
ADDRESS
CITY STATE

—MONEY-BACK IF NOT SATISFIED!—

B2a RADIO SERVICE EXPERT LEARN AT HOME IN SPARE TIME

The demand for radio experts grows every day. Learn this paying profession under personal guidance of qualified engineer and educator. Clear, fascinating instruction and experimental kits make learning easy. Leaders in the radio industry endorse R.T.A. methods. Spare time profits soon pay for training.

FREE book telling what R.T.A. training can do for you.
RADIO TRAINING ASS'N. OF AMERICA
1559 Devon Ave. Dept. RC-71 Chicago, Ill.

RADIO TECHNOLOGY

RCA Institutes offer an intensive course of high standard embracing all phases of Radio and Television. Practical training with modern equipment at New York and Chicago schools. Also specialized courses in Aviation Communications, Radio Servicing and Commercial Operating. For Free Catalog Write Dept. RC-41.

RCA INSTITUTES, Inc.
A Radio Corporation of America Service
75 Varick St., New York, 1154 Merchandise Mart, Chicago

RADIO-TELEVISION

Oldest, largest Radio-Television school in West trains you for good pay job. Complete instruction including Radio Construction and Service, Broadcast Operating, Sound, Talking Pictures, Television, Public Address, etc. Flexible plan to meet specific needs of those with or without jobs. Transportation allowed to L.A. Earn room and board while learning. Request Free Catalog.

NATIONAL SCHOOLS, Dept. 7-RC
Los Angeles

Here's How You can qualify for a better radio job

Are you "pinned down" to a routine radio job? The lack of technical training keeps the average radioman from getting a better radio job or even holding his present position. Facts will show how your own experience combined with CREI home study training can equip you for a better job and more money. Write today.

CAPITOL RADIO ENGINEERING INSTITUTE
Dept. RC-7 3224-16th St., N.W. Washington, D. C.

Order your copy NOW—the only

P. A. HANDBOOK

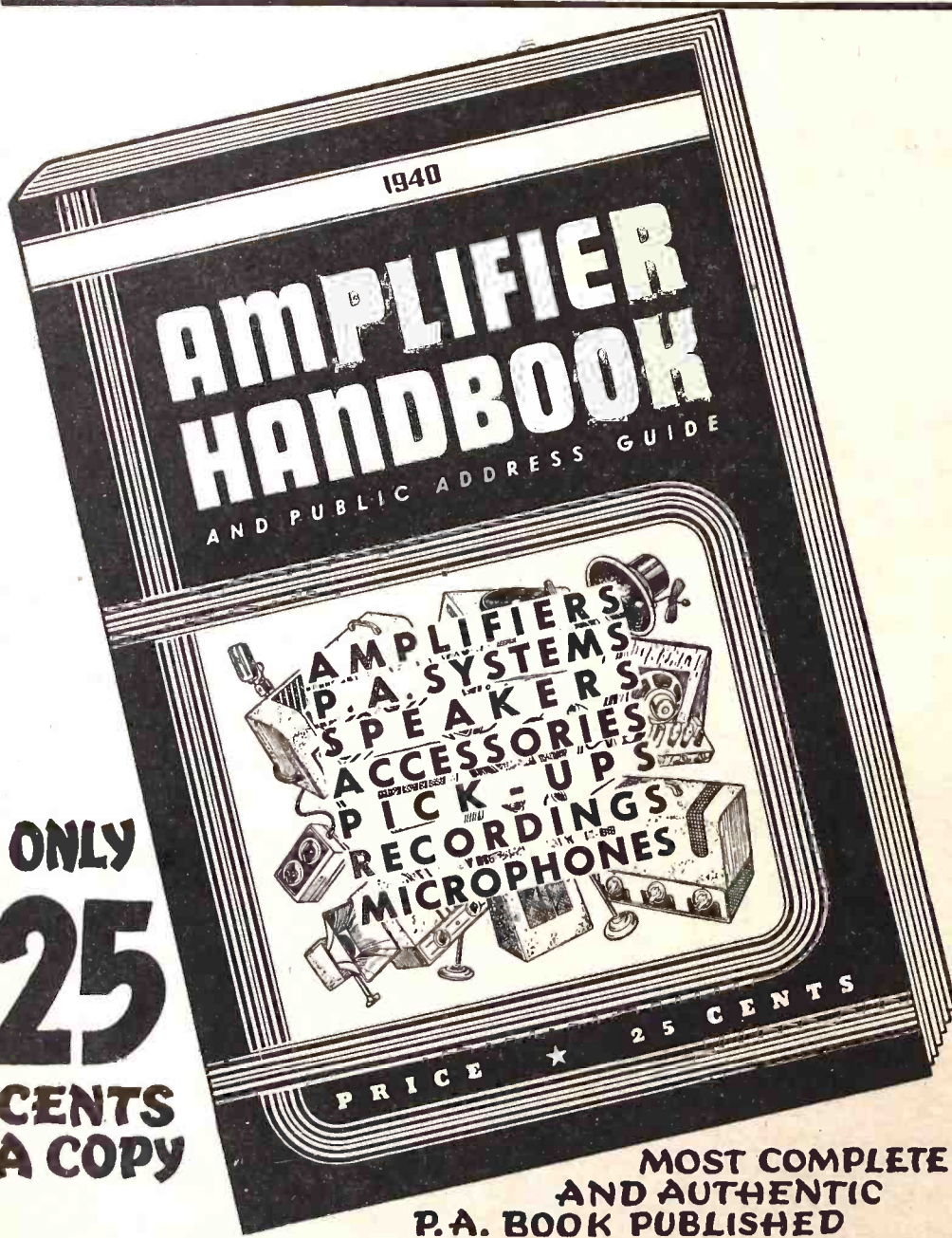

ONLY
25
CENTS
A COPY

**MOST COMPLETE
AND AUTHENTIC
P. A. BOOK PUBLISHED**

THAT no book has yet been published which covers amplifiers and sound systems (also kindred systems), in one complete, authentic volume is almost unbelievable. Yet, it is a fact, there is no book in print which covers Public Address from A to Z. To bridge this wide-spread gap, RADIO-CRAFT will publish a complete, magnificent volume on Public Address of such magnitude—so complete and authoritative—that every man engaged in radio can have both a theoretical and practical knowledge of the function and operation of sound systems. The editorial pages are so filled with instruction and replete with illustrations that the volume fully justifies its title of 1940 **AMPLIFIER HANDBOOK AND PUBLIC ADDRESS GUIDE**. This great HANDBOOK on Public Address should be read and studied by those who consistently build, service and sell sound equipment.

A MATCHLESS VOLUME

As complete as you would expect to find any engineering handbook—this is how the radio or P. A. man finds the **AMPLIFIER HANDBOOK AND PUBLIC ADDRESS GUIDE**. With essential technical data compiled from an exceptionally large number of sources, the volume covers nearly a hundred different subjects coordinating every conceivable branch or sub-division of Public Address.

THE CONTENTS

To actually show the scope and magnitude of the **AMPLIFIER HANDBOOK AND PUBLIC ADDRESS GUIDE**, an analysis of the contents is found at the right, showing the breakdown of the material featured within each particular section. A thorough reading of the contents shows the completeness of this book.

A Resume of the Contents of the **AMPLIFIER HANDBOOK AND PUBLIC ADDRESS GUIDE**

FOREWORD

INTRODUCTION

Definitions—decibels, frequency, input, output, impedance, etc.

SECTION I—SOURCE

Carbon microphones (single-button and double-button)
Condenser microphones
Velocity (ribbon) microphones
Dynamic microphones
Crystal microphones (sound-cell types, crystal diaphragm types)
Cardioid microphones
Contact microphones
Phonograph pickups (magnetic types, crystal types)

SECTION II—AMPLIFIERS

Voltage Amplification

Design of resistance-coupled voltage amplifiers

Commercial voltage amplifier

The Power Stage

Class A amplifiers

Class AB amplifiers

Class AB₁ amplifiers

Class AB₂ amplifiers

Class B amplifiers

When to apply class A, AB, and B amplification

Power Supplies

Half-wave rectification

Full-wave rectification

Voltage doublers

Filter Circuits

Power supply regulation, etc.

Practical Hints on Amplifier Construction

Microphonism

Placement of components

Tone compensation

Inverse feedback

Remote control methods

SECTION III—DISTRIBUTION

The Loudspeaker

Dynamic speakers

Speaker performance (frequency response, efficiency)

High-fidelity speakers

Speaker Baffles and Housings

Outdoor speaker installations

Power cone speakers

Radial (360° distribution) speaker baffles

SECTION IV—COORDINATION

Input impedance matching

Matching speakers to P.A. installations

Phasing speakers

Effect of mismatching speakers to amplifier output

A typical P.A. installation (in a skating rink)

SECTION V—USEFUL PUBLIC ADDRESS DATA AND INFORMATION

Speaker matching technique

The ABC of Db., VU, Mu, Gm and Sm

Charts and formulas useful to the practical P.A. sound man

Handy index to important articles on public address and sound

RADCRAFT PUBLICATIONS ■ 20 VESEY STREET ■ NEW YORK, N. Y.

RADCRAFT PUBLICATIONS, INC. ★ 20 VESEY STREET ★ NEW YORK, N. Y. RC-741

Gentlemen: Enclosed find my remittance of 25c for which send me POSTPAID, one copy of your NEW—1940 **AMPLIFIER HANDBOOK AND PUBLIC ADDRESS GUIDE**.

Send me others, for friends, also POSTPAID @ 25c each.

Name Address

City State

Remit by check or money order; register letter if you send cash or unused U.S. Postage Stamps.

Order Your Copy NOW—

*Clip Coupon and
Mail Today!*

RADIO-CRAFT

"RADIO'S GREATEST MAGAZINE"

WAR RADIO WEAPON

By the Editor — HUGO GERNSBACK

. . . *Radio is as important a war machine as airplanes, bombs, tanks and guns*

BY now it should be thoroughly understood and realized by everyone that Radio Communication, as well as radio in many other phases, *is just as important a war machine as are tanks, airplanes and guns.*

In many instances, radio might be said to be even more important than a war machine because it works faster than either guns or airplanes and can do more damage in less time. Radio knows no frontier, and when it comes to insidious propaganda, there is no question that it can be used effectively as 5th Columnist's efforts with little chance of being caught in the act, as is the case of human beings in a foreign country.

How seriously the greatest military power on earth—the Nazis—consider radio, and how well aware they are of all its potentialities, is clearly indicated by the fact that the Germans do not hesitate to impose not only heavy fines, and even imprisonment, but often the death penalty, on those who listen-in to foreign radio broadcasts. Even amateur radio recently came up again in the news when the Nazis indicated that radio amateurs caught sending out messages would be sentenced to death.

There is nothing new about all this, but the point remains that from a technical angle, our radio engineers so far have not been able to devise counter measures that would be 100% effective against enemy broadcasts. To begin with, we have fixed broadcast stations which send out propaganda over long distances. We also have mobile broadcast stations, on war airplanes, tanks, submarines, etc. If, for instance, you were to nullify radio communication between war airplanes and their base, the airplanes could no longer function as they do today.

Yet, so far we have not been able to devise radio barrages which would satisfactorily drown out enemy broadcasts, whether originating from fixed or mobile stations.

You may rest assured that 25 years from now things will be different. Means will have been found so that radio broadcasts no longer will be able to penetrate territory into which it is not supposed to go. In the future, when an enemy airplane flies over the boundary, its radio operator will no longer be able to communicate with its own base.

"How will all this be accomplished?," you may ask. So far it is known that no one has been able to set up sufficiently powerful transmitters that would drown out broadcasts originating in other countries so that they could not be understood inside the border.

Of course, the art of radio is still young and the great importance of radio communication during war has not as yet been fully realized and appreciated by the military staffs of the various nations.

Moreover, it takes time and a very large outlay of money, to provide the means to effectively keep enemy signals from crossing border lines.

It probably will become necessary to erect special transmitting units in various parts of the country, particularly near its borders, where directional signals of great intensity will go on the air the instant when enemy signals of any kind are broadcast. It probably will be said that if you do this you will drown out your own signals as well. In other words, radio engineers will tell you that you can drown out the enemy but you also will kill out all your own radio signals.

This is not necessarily so. It may be true *today* but it will not be true in the *future*. Ways will be found, I am quite certain, so that normal radio traffic can go on within a country yet enemy and other outside broadcasts will be nullified completely. It most likely will all be accomplished by some new means not as yet used, and probably by special equipment which directs barrage waves against the enemy, yet does not interfere with the country's own signals.

All of this is, of course, important—not only for ordinary broadcasts but, far more important, when it comes to airplanes, tanks and other war machines which today are dependent upon effective radio communication, not only with their own bases but with their own squadron as well.

I feel quite certain that many new radio-defensive inventions will come about in a not very distant future, to make possible all of the above. Many intricate technical problems, of course, remain to be solved before all this can be accomplished, but it is not hopeless and certainly not impossible. If we had a better knowledge of what takes place in open space in regard to radio waves, we would perhaps be in a better position to solve the problem more quickly. There is no doubt, however, that intensive work along these lines will be attempted shortly.

War history shows that there has never been a war weapon which did not have its ultimate answer. Radio as a war weapon will be found no different.

• THE RADIO MONTH IN REVIEW •

The "radio news" paper for busy radio men. An illustrated digest of the important happenings of the month in every branch of the radio field.



OMNIDIRECTIONAL LOUDSPEAKER
(Cover Feature)

In an effort to simulate a sphere vibrating radially and thus emitting equal sound energy in all directions, the arrangement of 21 individual units shown in the above photo was devised under the direction of RCA's Dr. Olsen. Purpose of this experimental development was to obtain subjective comparisons between directional and nondirectional loudspeakers. The P.M. dynamic units are connected in series-parallel, and the combination driven by a 40-W. amplifier. In the photo, a technician is shown utilizing a stethoscope to check standing waves on the surface of one of the accordion-edge cones.

DEFENSE

In order to circumvent a bleak outlook for the radio industry, now beginning to feel the pinch of the National Defense Program, *Broadcasting — Broadcasting Advertising* magazine last month editorialized: "It seems to us the Defense Communications Board, functioning directly under the President, should take a hand in the whole physical radio picture, and certify to OPM (Office of Production Management, which includes the Priorities Division, the action

of which, in including aluminum on the list of essentials for Defense needs, was the subject of an item in this department last month, with particular reference to sound-recording blanks.—*Editor*) that radio is a vital defense industry. Otherwise conditions can become chaotic quicker than many imagine."

U. S. Army Signal Corps "Training Films" have been completed, and others are in the process of completion, in Hollywood. These sound motion pictures include the following subjects: Instruction of the Individual Infantry Soldier; Instructions on the Techniques of Operating and Firing the 240 mm. Howitzer; Instructions on the 60 mm. Mortar; Basic Principles of Skiing (showing the soldiers of the Ski Patrol of the 15th Infantry); and, "Military Courtesy and Customs of the Service" (just completed). It should not tax any radio man's imagination to conjure-up an impression of what this means in creating a demand for sound and electronic equipment—loudspeakers, photocells, amplifiers, etc.; and in developing a technical crew to maintain this equipment throughout the U.S. and its Possessions—a crew which, in part, will return to civilian radio, come more pacific times.

One of the form letters William S. Knudsen issued last month was addressed to Radio-Craft and contained suggestions that make sense for the owners of plants—large and small, radio and otherwise—that are capable of aiding, in any way, the Defense Program. Knudsen's OPM is steering. He suggested: (1) don't wait for new machine tools—get started with second-hand tools, if possible; (2) use the tools you have on hand, if you can—look around, maybe some of the tools you need are now in use in non-Defense work and can be redirected to the more urgent demands of the Defense plans; if you need sub-contractors, advise the OPM, which has set up machinery to provide every aid in this direction. Keynote of his remarks: "Don't wait! Do it now!"

Last month Audio Devices, Inc., announced a glass-base sound-recording blank. The company pointed out that the use of aluminum substitutes in making blanks for home-recordings, transcriptions, etc., would release about 1 billion pounds of aluminum annually for use in bombers and other Defense equipment, without affecting radio broadcasting (including the manufacture of radio sets).

BROADCASTING

NILES TRAMMELL, President of NBC, in announcing "Good Neighbors," a new half-hour program designed to bring Latin America to the United States, announced this contribution to the Government's good neighbor policy as NBC's "attempt to build a bridge of knowledge of our neighbors to the South, a veritable Latin American radio highway of understanding."

Tip for Servicemen and equipment builders: A survey by WOR last month revealed that 60% of the boats on Long Island Sound and in the waters off the New Jersey shore had radio sets aboard. In this group 60% were portables.

Add new terminology: Announcers' Stomach. The sensation itself is explained as a reaction from nervous tension that disappears when a person starts talking.

Station KGO in Calif. last month won the General Electric Company's merit award (silver trophy) for the N.B.C. station having the best record of least lost time through technical failures during 1940, viz., 31 seconds in a total of 6,406 hours and 53 minutes of air time. Congrats. on a fine job, KGO.

New Radio Job: Farm Editor. Station KDKA announced the creation of this post at the station during the process of inaugurating a special early morning program as part of a new service to farmers. This farm hour, it is estimated, will be of interest to 44% of the residents in the service area of KDKA's 50 kw. signal on 1,020 kc.

Station KMA, Shenandoah, will broadcast graduation exercises specially designed for



(Photo—The Register and Tribune [Des Moines, Iowa])

SCHOOL AT HOME

At upper-left is Tanya, one of the many "shut-ins," whose physical afflictions keep them at home but which do not impair their ability to learn. She, and other Iowa children "go to school" via intercommunicators beside their chairs or beds which are linked by telephone wires with similar instruments in their classrooms. Since the instruments are 2-way affairs, classes are conducted in the normal way, the absent pupils taking part along with those in the class-

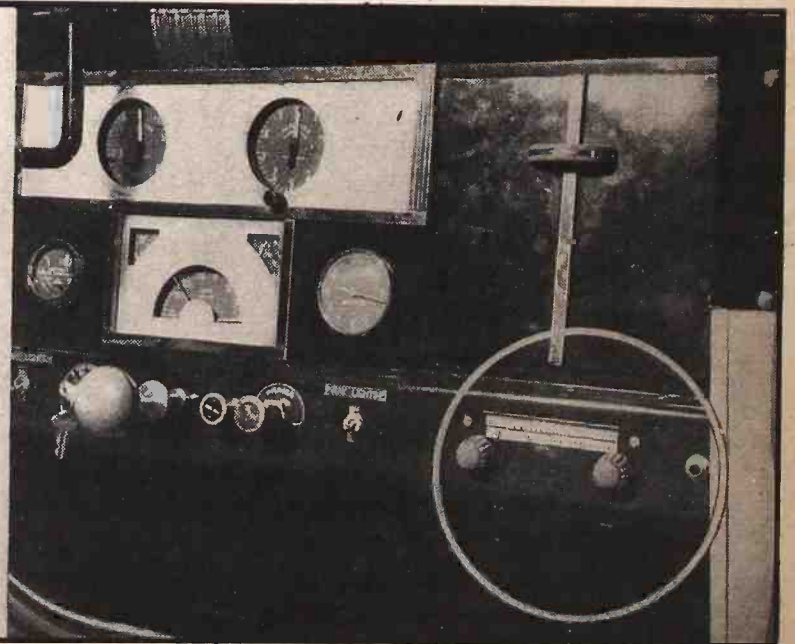

RADIO FOR PRIVATE PLANES

The instruments are provided by the State while the telephone wire charges are borne by the local school districts.

In the upper-right-hand photo is shown the instrument panel of a new 1941 Piper Coupe, with custom-built RCA aircraft receiver. It is the first private airplane to have a radio receiver as standard equipment. This radio set will receive not only standard broadcasts but also all weather information as well as the "beams." Looks like a car-radio set. (See controls in circle.)

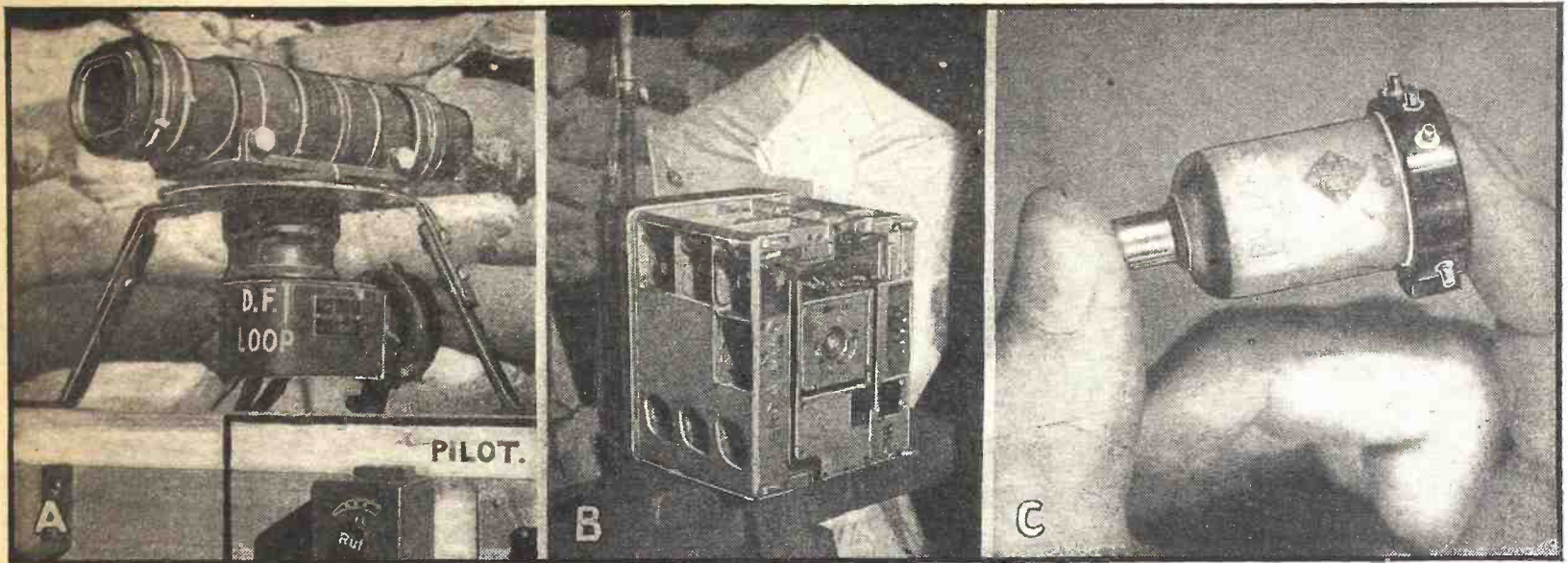

LUFTWAFFE RADIO

Although there is nothing new in principle in radio apparatus used by the German *Luftwaffe*, their mechanical genius shows up in the compact construction of the various components. The apparatus shown in photo A is an iron-core direction-finding loop which leaves little to be desired in the way of compactness. The unit in photo B is a combination receiver and transmitter, which due to the use of extensive die casting in its construction, makes for good frequency stability under flying conditions. Photo C shows the radio

tube used! Only one tube type is used for all positions in both receiver and transmitter, making the problem of replacement a simple one. This tube is a pentode suitable for all frequencies! By having its contacts protrude around the periphery of the tube, short leads and compact wiring are achieved.

Generally, 2 receivers are used in each German airplane, one for 3 to 6 megacycles and the other for 300 to 600 kc. Two transmitters of course are also used covering the same wave-bands.

the 8,000 rural schools in Iowa too small to hold separate commencements with complete graduation exercises.

Comments on the F.C.C.'s statement last month on network regulations tending to materially affect the present setup of radio stations:

M.B.S.: "A scholarly and thorough analysis of the network monopoly situation."

N.A.B. (representing the opinions of The Big Two, N.B.C. and C.B.S.): It will "make certain a confusion that must lead to a further bureaucratic grip upon the freedom of the air."

Opinion of the minority group of the F.C.C.: "More likely to create anarchy."

The Big Two: "The revolutionary changes announced by the Commission should have received the consideration and specific approval of the Congress, which created the Federal Communications Commission, not to make laws, but to administer them."

Problems of a special features broadcaster: The 5 minutes WOR's Josephy was



ARMY RADIO "PAPER"

Facsimile is in the Army now. Station WOR (New York) has installed a facsimile receiver at Fort Dix, N.J., and transmits army news on a (presently) once-a-week schedule. Although experimental in nature, the transmission of news by facsimile to Army camps is believed to have potentialities in terms of morale and essential information. Main problem will be the distribution of sufficient receivers. This receiver has been installed in Reception Center, where it is available for all soldiers to read. Photo shows the first of the 5 (*Radio-Craft*-size) pages which go to make up an issue of the *Reception Center Gazette*.

on the air from the 2,600-acre powder and shell reservation at Picatinny Arsenal, near Dover, N. J., was possible only after he had been thoroughly searched and all matches taken away, in accordance with Arsenal rulings which also dictate that broadcasts be made from the fuse assembly line plant, since the battery boxes required for remote broadcasting were taboo near explosives—for example, on the powder assembly line. If an electric storm had prevailed, no broadcast from the Arsenal would have been possible since all workers around the plant must then take to special shelters, to guard against the contingency of lightning striking a powder building.

It must be the Oriental in the (WOR) Nilsons—Mr. & Mrs. Last month Alfred Nilson celebrated the 18th anniversary of housekeeping aboard his 70-ft. Chinese junk Amoy. Its blood-red sails have been a familiar sight on the waters between New Rochelle and New York City during the 4 years that Nilson, with his "crew" of wife and 3 sons, has used his 4-room camphor-wood conveyance between his home, and his job as engineer at the WOR studios on Broadway.

Just as the newspapers spare no effort or expense to keep the contents of their publications within the confines broadly defined as "maximum reader interest," so too do the broadcasters bead an eagle eye on what does, and what does not, interest Mr. Average American Listener. Right now, it seems that national interest in Herr Hitler's voice is at ebb, and so, the networks have exercised their own good judgement in the matter and thus der Fuehrer's broadcasts these days seldom rate more than passing mention by a news commentator. The English-speaking orators, however—Churchill especially—have greater listener interest, say broadcasters, according to a News (N.Y.) item by Fred Pasley, last month.

ABROAD

LONDON — An abstract in *English Mechanics*, done on an article by D. W. F. Mayer in *Discovery*, tells how the feeble heat of infra-red rays given out by an airplane are being used in airplane detectors. Sufficiently

sensitive to detect the heat of a candle at 50 miles, these devices detect enemy aircraft headed Great Britain-way long before the sound of the engine can be picked up by the most sensitive sound detectors.

The item, in continuing, points out that experiments are progressing in America on utilizing such infra-red radiations from an enemy plane to steer into it an unmanned aircraft loaded with explosives. The hot exhaust gases of a bomber would cause the ship to seal its own death warrant by steering the aerial torpedo right smack into it.

Toronto—A "special transmitting detector" was used by Royal Mounted Police in tracking down an illegal radio station sending Communistic and anti-British propaganda nightly, according to an item in *Radio Daily* last month.

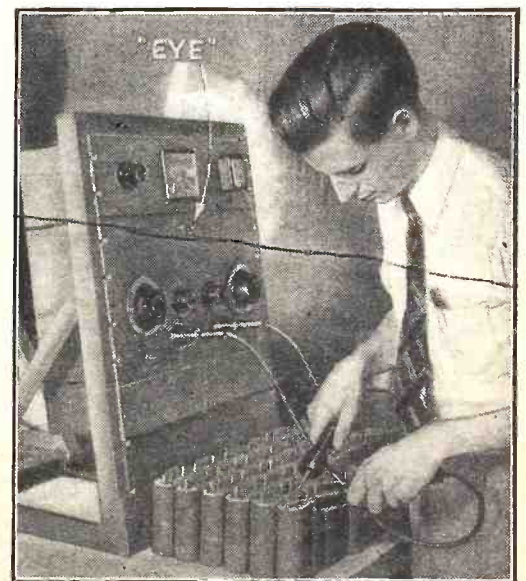

INDUSTRIAL "EYE"

The "eye" sees all, knows all, tells all. The banks of coils and condensers which make up the bulk of telephone repeater stations once constituted a laborious job to check before placing into operation. Now the electronic "eye" does it very quickly. Current is applied to the terminals of each repeater. Any deviation from standard resistances may be made to either change the angle of shadow of the "eye" or energize a buzzer. The buzzer method is used for ordinary checking while the visual method is used in rechecking. Continuous buzzer indicates that I.R. is below standard; short buzzer or no buzzer is indication that I.R. is above standard. The apparatus was developed by New York Telephone Company engineers.

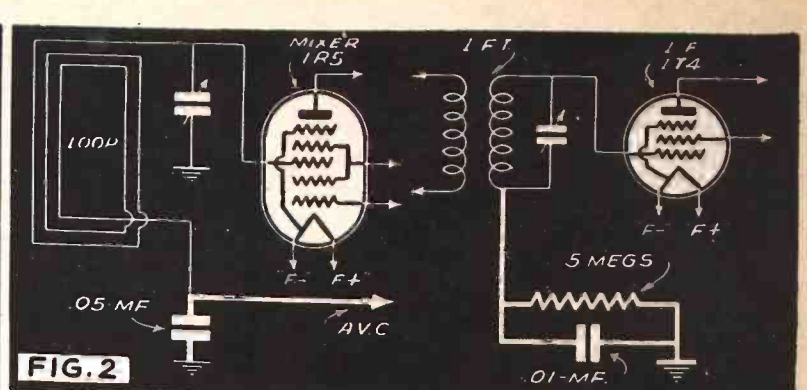
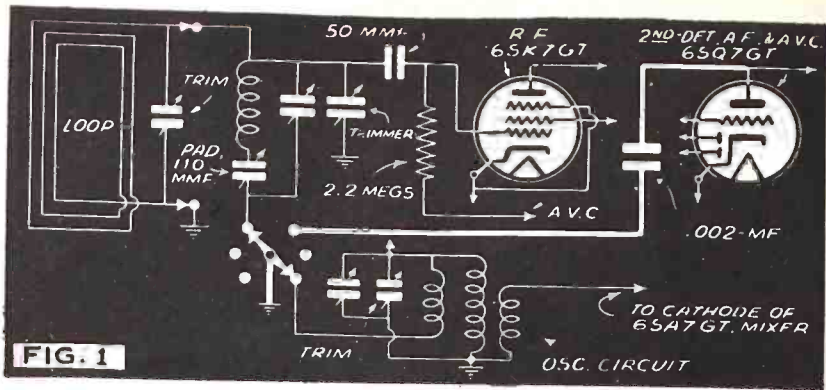

NEW CIRCUITS IN MODERN RADIO RECEIVERS

In this series, a well-known technician analyzes each new improvement in radio receiver circuits. A veritable compendium of modern radio engineering developments.

F. L. SPRAYBERRY

No. 46



(FIG. 1.) STEP-TYPE TONE CONTROL COMBINED WITH WAVE-BAND SWITCH

MOTOROLA MODEL 40-60W.—By adding one extra position to the wave-band switch a step-type tone control is made to utilize the same shaft and knob, thus simplifying and reducing the controls of the receiver.

From the circuit in Fig. 1, it will be observed that the wave-band switching is of the shunt circuit type such that input and oscillator tuning elements are placed in shunt with the broadcast-band tuning elements. They are placed in service simply by grounding their free ends.

When both circuits, that is, the high-frequency input grid and oscillator circuits, are opened, the broadcast band is tuned and the tone control is in the *treble* position. Obviously the next position of the switch provides the *bass* position of the tone control. While the tone control cannot be changed to the bass position for the short-wave band, this is not regarded as useful.

(FIG. 2.) LIMITER ACTION COMBINED IN CIRCUIT USING A.V.C.

ADMIRAL MODEL 28-G5.—Through the use of independent types of automatic control of gain in this receiver it can adapt itself better to different signal strengths.

The mixer tube in Fig. 2 is controlled in the usual A.V.C. manner while the I.F. am-

plifier is self-controlled by a limiter type of circuit. In this way the total gain of the receiver for each signal of different strength may be shared differently between the mixer and I.F. tubes. For a strong signal the mixer would share more than its usual portion of translation gain, while for a weak signal the I.F. amplifier gain would be predominant. The advantages accruing from this circuit would be, (a) reduced cross-modulation, and (b) a better-distributed sensitivity range.

(FIG. 3.) REGENERATION INTRODUCED AT THE MIXER

SENTINEL MODEL 2Z7P.—Some amount of regeneration is introduced into the R.F. system of this receiver to sharpen its R.F. tuning and reduce image and other interference.

Regeneration is acquired by supplying the screen-grid through the oscillator plate coil so that this plate coil may act as a reactance in series with the screen-grid circuit. Note that the screen-grid bypass condenser is simply connected across the screen-grid voltage dropping resistor instead of from screen-grid to ground.

In addition to serving as the oscillator anode in common with the mixer plate, the screen-grid may feed energy back to the signal control-grid by virtue of the capacity between them. The oscillator anode or

feedback coil has a very small reactance at signal frequencies but it is sufficient to produce some regeneration for its well-known advantages.

(FIG. 4.) SENSITIVITY CONTROL IN COMBINATION WITH WAVE-BAND SWITCH

ZENITH MODELS 8S593 AND 8S594.—Sensitivity is arranged in 2 steps for the broadcast and high-frequency bands respectively by introducing an R.F.-mixer-I.F. bias through the A.V.C.-return without disturbing the ground connections of the cathodes in the high-frequency part of the receiver.

As in Fig. 4, the cathodes of the entire audio and 2nd-detector system are given one negative bias for broadcast reception and another bias for shortwave reception. The resistors used for producing this cathode bias are chosen to cause a negative bias of the cathodes of approximately 7 volts for the broadcast band and 3 volts for the shortwave band. This reduces the sensitivity of the receiver for broadcasting to keep it well above the noise level while for short-wave reception certain noise must be tolerated in the present state of the art.

All audio grid and diode returns are brought to their own cathodes or to a bias system which is essentially unaffected by the cathode potential changes achieved by the circuit.

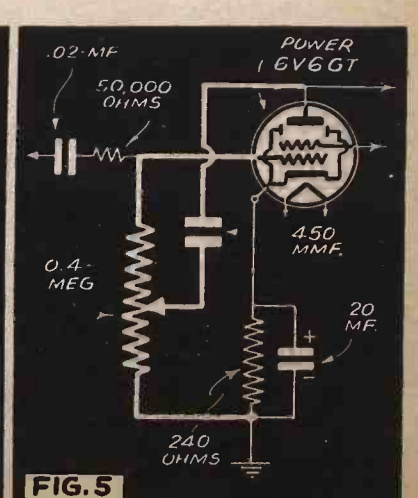
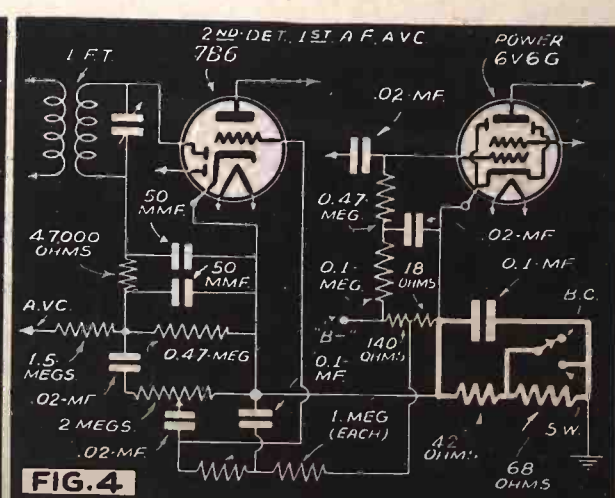
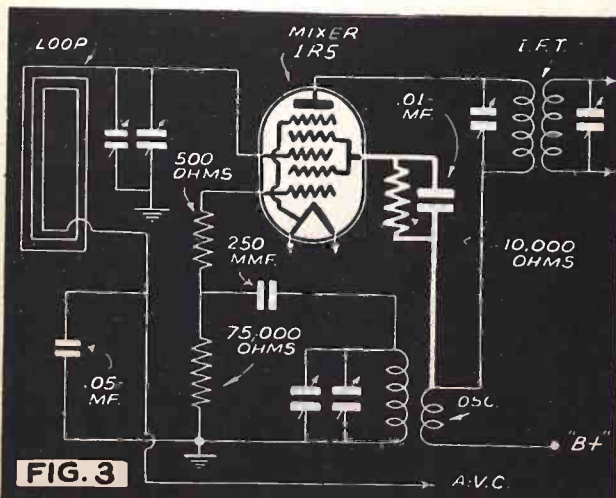

(FIG. 5.) CONTROL OF TONE ACHIEVED BY VARIABLE AND SELECTIVE DEGENERATION

EMERSON MODEL EV-384.—Tone is controlled by progressively feeding-back the high frequencies in the signal so that the degree of degeneration attenuates the high frequencies at one setting while the by-

passing effect stabilizes the high frequencies at the other setting.

Adjustment of the grid potentiometer, as in Fig. 5, for maximum feedback produces increasing attenuation as the frequency is increased due to large-order degeneration. The tone is thus mostly bass because the feedback factor is excessive tending to greatly reduce the high frequencies. As the

slider is moved down, the feedback factor is reduced very rapidly, and is of course zero at the ground end. Here the condenser coupling the potentiometer slider to the plate of the 6V6GT tube directly bypasses the very highest frequencies, but the capacity has such a high reactance as compared to the plate load, that there is no noticeable loss of high audio frequencies.

OPERATING NOTES

Trouble in . . .

PHILCO 20, 20A & 21

These T.R.F. receivers of several years back can be modernized very easily to incorporate smooth A.V.C. and increased sensitivity. (See diagram.)

I usually drill a hole in the back of the chassis and mount the old double volume control there as a sensitivity control. The antenna half of the control is no longer used. Of course, fixed resistors could be inserted and the original volume control could be thrown out completely.

This scheme of A.V.C. can be used on practically any of the old T.R.F. receivers having similar circuits to these Philco receivers. Of course, the new iron-core coils could be used to replace the old coils in such sets and type 35 tubes used instead of the 24 type. By all means, replace with new units, the R.F. cathode bypass condenser, the audio coupling condenser and the screen-grid bypass condenser. And, of course, realignment is necessary after the receivers have been revamped for A.V.C.

(No name submitted.)

ZENITH 33 and 33X

Lack of selectivity, or oscillation in this receiver may be caused by an open antenna coil, this coil is located in the inverter can below the 1st R.F. tube socket and under the chassis. If it is necessary to replace this unit, realign the circuit for maximum response.

MOTOROLA 77A

If the sensitivity of a 77A is poor, due to excessive bias on the type 85 tube cathode, reduce this value to 500 ohms; also check the I.F. amplifier for correct alignment, as this sometimes shifts off resonance, thus causing distortion.

WELLS-GARDNER AUTO-RADIO 06Z

Complaints of vibrator noises or receiver dead, or circuit oscillation, may be caused by cathode leakage, or short-circuit, in one of the tubes; a defective filter condenser; or, a broken lead near the terminal of the 0.02-mf. condenser across the power supply secondary (replace with a new condenser, and at the same time, anchor it in some convenient manner).

ATWATER-KENT 165

If the complaint is distortion and audio howl, replace the control-grid resistor in the 2A6 tube circuit; if this does not cure the trouble, replace the volume control.

SERVICEMEN—

What faults have you encountered in late-model radio sets? Note that *Radio-Craft* will consider your Operating Notes (they need not be illustrated) provided they relate to CHARACTERISTIC (repeatedly encountered) faults of a given set model. Payment is made after publication of the Operating Note.

RCA VICTOR 331

Lack of plate voltage on the 58 R.F. tube is frequently caused by a defective or open contact on the Radio-Phonograph transfer switch, do not attempt to repair this unit, but replace it with a new switch assembly. Wavering or vibrating of the record with reproduction, or sometimes strong hum may be noticeable; this trouble is caused by one forgetting to remove all of the phonograph shipping blocks.

STROMBERG-CARLSON 846

Noisy reception, and sometimes oscillation, in this set model occasionally is due to a high-resistance junction of the tuning condenser rotor contacts, due to dirt or oily condition of; also a short-circuit of turns, or high-resistance joints, in the 1st audio transformer following the detector tube. It will be necessary to replace this with a new unit; also check the primary and secondary of the push-pull transformer. In cleaning the condenser rotor plates use a pipe cleaner and be careful not to bend the plates.

PHILCO 118

Low volume and incorrect action of the shadow tuning meter sometimes is caused by a defective plate-to-grid coupling condenser (78 plate and 6A7 grid). This unit is located within the oscillator coil, and is rated at 180 mmf., mica. Replacing it cures this trouble.

GENERAL ELECTRIC 109

Complaints in connection with this set model may be: (a) motorboating; or, (b) oscillation between stations, or sometimes, distortion at resonance.

The first trouble is frequently caused by corroded condenser-gang rotor contacts, a condition easily cured by cleaning and bonding the rotor plates to the chassis with a piece of braided shielding used as a pig-tail; the second cause of distortion may

be a leaky 1st-detector and 2nd I.F. secondary bypass condenser (value, .05-mf.).

GEORGE F. BAPTISTE,
Howard, R. I.

RCA MODEL R-10 (and other older sets)

When these sets "motorboat," yet everything checks OK, remove the tuning condenser and clean the mounting brackets, also tighten the bolts as they may be making imperfect contact with the chassis, due to dust, dirt, and vibration.

WILLIAM J. ROEHRDANZ,
Kewaskum, Wis.

DETROLA 274

The tone and general performance of this set can be improved by replacing the 12-mf. condenser with a 30-mf. unit. The higher capacity improves the filtering.

GENERAL ELECTRIC H-610

This set failed to align correctly in several attempts. The trouble was a shorted 0.05-mf. condenser in the A.V.C. circuit (condenser C7 in the factory diagram).

GENERAL ELECTRIC A-61, A-62

Frequent complaints of weak operation of these sets are caused by shorted 0.05-mf. condensers in the plate circuits of the 1st-detector and I.F. stages.

PHILCO 37-650

A number of these sets have been in the shop with the complaint of low volume and intermittent reception. After checking the set for other ills, we found the tube sockets to be the trouble. Bending the contacts does not remedy the trouble.

The only permanent repair is to replace all of the sockets which are found to be defective.

SONORA KFN-99

These sets often cut-off after operating for 5 to 10 minutes. The trouble may be traced to an open oscillator coil. The oscillator coil has a feedback winding, which may be confusing in checking the coil for continuity.

ZENITH 6A10

The cause of intermittent reception in this set is often a defective 0.01-mf. condenser, which connects from the arm of the volume control to the control-grid of the 12SQ7GT tube.

JOHN LINK,
Corryton, Tenn.

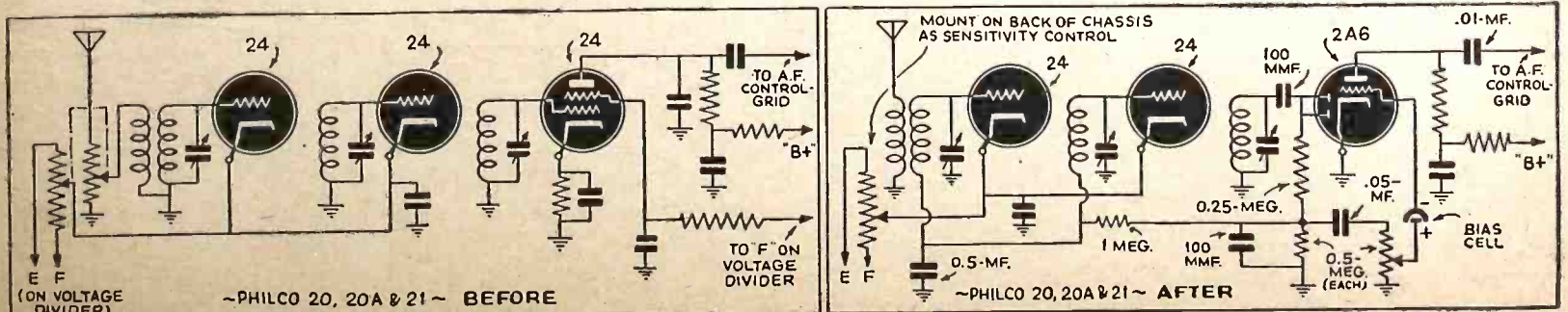

The Latest Developments in

1941 AUTO-RADIO CIRCUITS

Author Stang here interestingly glosses over the early stages of car-radio development and then proceeds to describe new developments. These include shortwave reception, and improvements in circuits, power supplies, speakers, tubes and other components, etc.

BOB STANG

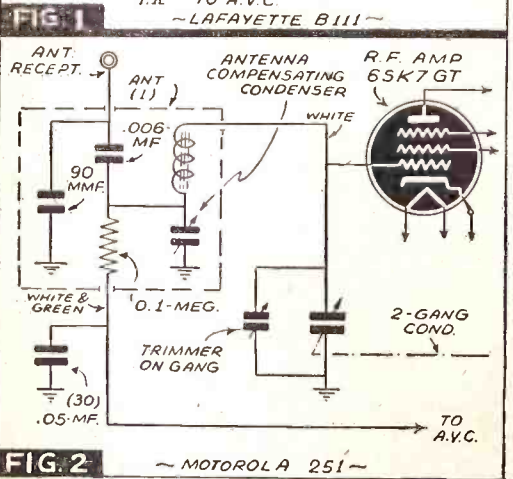
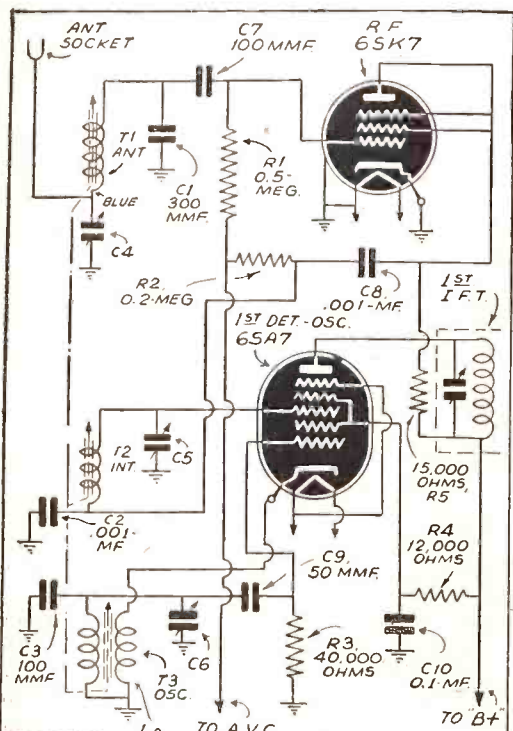

WITHIN the last several years Automobile Radio has come into its own. Once considered a novelty, and not comparable to the home radio in its ability to reproduce the program, the average car set of today gives the home radio receiver a run for its money, and in most instances out-performs by far the small home radio in an equivalent price range!

POWER ECONOMY

The problems that confronted the engineer were manifold. The only source of power was the 6-volt battery of the car's ignition system, and here he couldn't draw too much current or he would be interfering with the car's performance. At first, if you remember, the car-radio receiver was looked on as a battery set and the storage battery was only used as a filament supply, "B" batteries kept beneath the driver's seat being used as an auxiliary power supply. This was expensive. Then the car-radio type of generator-motor combination was developed, and though moderately expensive initially, was somewhat of a solution of the problem. Then came the non-synchronous vibrator and what a boon that was to the industry; immediately there mushroomed forth many sets with self-contained power supplies, completely operative from the storage battery of the car, this with the advent very shortly thereafter of low-current-consumption tubes laid the groundwork for the present line of sets.

Permanent-magnet or "P.M." speakers of the Alnico field type have made it unnecessary to consume battery power for field excitation, and the invention of the synchronous vibrator has reduced the required tube complement by one.

CONTROLS

The old, unattractive control head mounted on the steering post or under the lip of the instrument panel has given way to the

equally attractive method of incorporating the control head into the panel itself, where it enhances the panel's appearance and is much more convenient in operation. Push-button tuning found excellent application in the car set, as one of the objections from the beginning was the inconvenience to the driver of the method of tuning the radio set while the car was in motion.

More and more the Auto Set is being looked at as an automobile accessory, and it will be noted that recently many of the manufacturers are devoting most of their energies to turning out custom-built sets for the Automobile Industry. The obvious advantage here is the opportunity to design a particular set to occupy the least possible room while giving the maximum performance. Leg room being a consideration in the average automobile, this policy goes well with such similar developments as the elimination of the shift lever from the modern car. Of course such specialized policy also makes it possible for the engineer to place his components in the best possible location from the viewpoint of performance. Results obtained from this are (a) better acoustical speaker location and (b) a minimum amount of noise pick-up from the car's ignition system.

Speaker location of late has become largely a matter of the driver's preference, as many car manufacturers have begun to provide a grille in the instrument panel, and some have also provided room for an auxiliary speaker above the windshield so as to permit a speaker in this location to distribute a given volume equally between both front and back portions of the car.

LATEST DEVELOPMENTS

This year's new sets show that the evolution outlined above has even now not reached its peak. Rather than rest on their laurels, the set manufacturers have currently brought forth improvements that in-

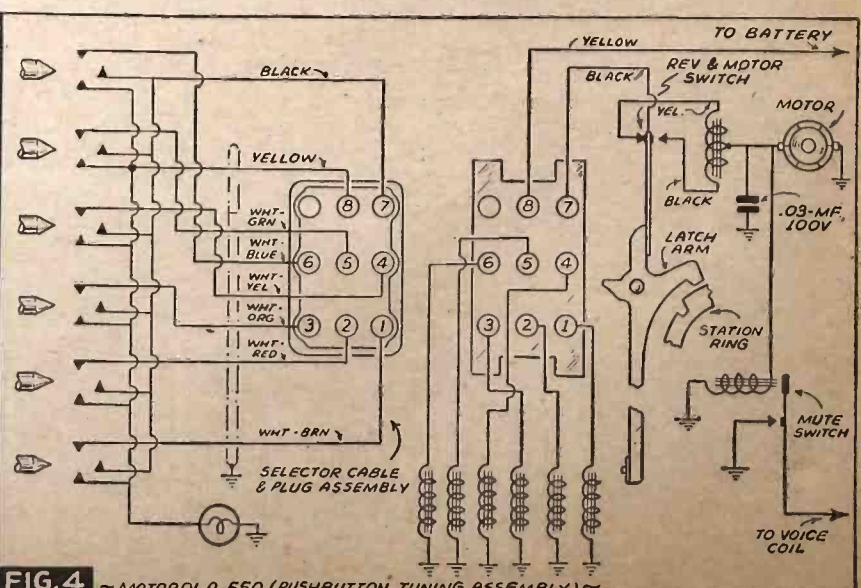
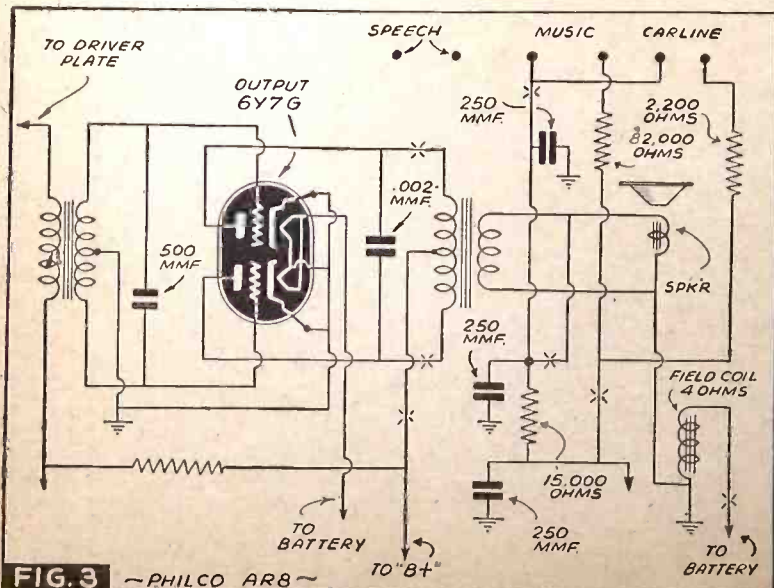

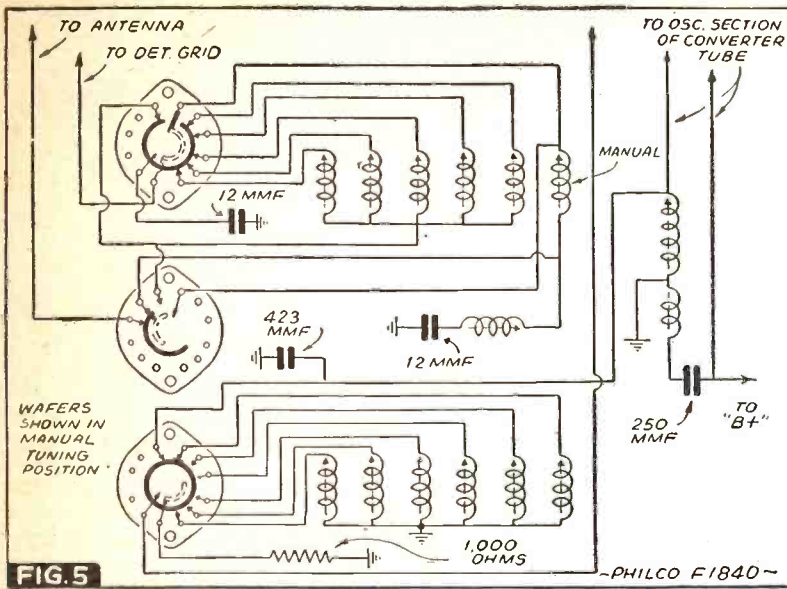

FIG. 5

~PHILCO F1840~

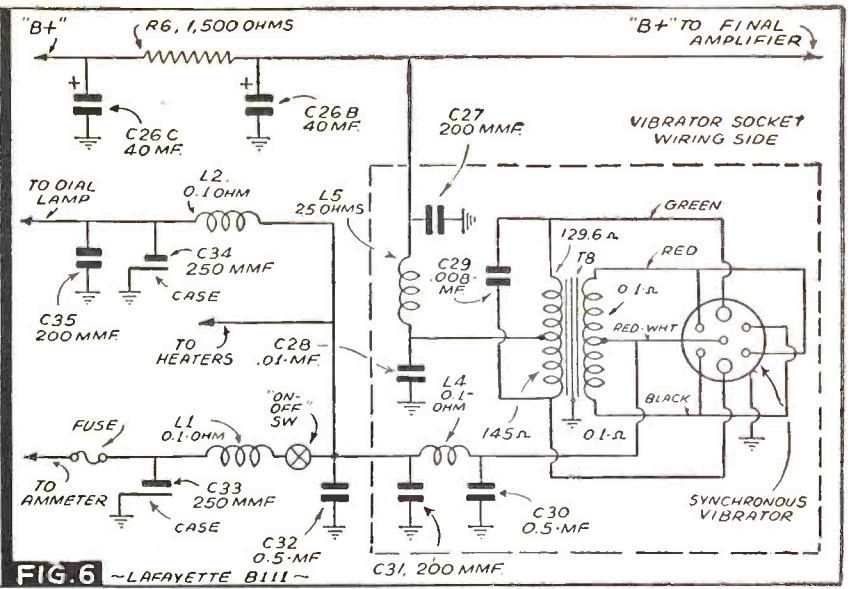

FIG. 6

~LAFAYETTE B111~

sure that this year's sets will out-perform anything before them. Notable among these is the use of permeability-tuned circuits. Although a tuned R.F. amplifier is admittedly advantageous, it has been avoided because of the additional expense and the room required to house the 3-gang condenser that it requires. Instead, untuned R.F. stages and even resistance-capacity coupling has been substituted.

This year, some manufacturers are incorporating a tuned R.F. stage by using small trimmers in conjunction with a 3-gang variable-permeability tuned circuit that occupies very little space yet gives very much greater gain (Fig. 1). There is a dual advantage here, as the additional tuned circuit gives a greater amount of selectivity while the permeability coupled circuit makes for far greater gain. Note that condenser C1 is a fixed type (silvered mica, for stability), while C5 and C6 are variable trimmers for alignment purposes.

One idealistic development toward which home-radio engineers have done much wishful thinking in the past, is the eventual development of a standard receiving antenna. If this were an accomplished fact, all-over receiver gain could be tremendously improved by the design of an antenna input circuit that could assume an antenna of fixed capacity. This has been accomplished by the car-radio engineer by using somewhat standardized antennas, the capacity of which varies little in different installations and where the capacity of the shielded input lead can be taken into account as it is provided with the set. Small variations in this total input capacity are compensated-for by varying the antenna trimmer. The input circuit is almost invariably of the so-called low-impedance, capacity-coupled type that gives a good match between input and antenna impedances with the accomplishment again of additional gain (Fig. 2). All this additional gain may seem unnecessary since usually the only required stations are locals, but it is intended rather to accomplish a good signal-to-noise ratio, and this accounts for the surprisingly quiet reception of the new sets.

Sufficient audio output has not been a problem in the auto set since the advent of the beam power pentode. These tubes have become almost standardized equipment in most car-radio receivers because of their high gain with small component size. The writer was pleased to note, however, that several of the new sets—notably the Philco AR8 and the Lafayette B111—accomplish high gain by the use of a class B output stage using triodes (Fig. 3). By taking advantage of the new 6N7 and 6Y6G dual-triode tubes no room is wasted. The percentage of distortion of an output stage

of this type is considerably less than that of a single beam-power pentode stage of equivalent power output. In addition, hum and harmonic distortion are canceled out, while undistorted outputs in the order of 7 to 8 watts are usual.

PUSHBUTTON TUNING

The advantages of pushbutton tuning are still somewhat debatable. At present only the more expensive sets incorporate it and the question seems to be whether the additional advantage obtained compensates for this additional expense as well as the increased size of the resultant set. Where set size has been a consideration, minimum size has had to be obtained at the expense of other important components. Two types of pushbutton tuning are at present in use. One of these, the motor-driven type, uses a small motor driven by the car battery to mechanically operate the gang condenser (Fig. 4), while the other is the same as the pushbutton method most commonly used in the home radio, namely using independent tuned circuits, usually tuned by means of variable inductances, permeability-tuned, across which are small, fixed, silvered-mica condensers (Fig. 5).

Power supply circuits have not changed radically. The synchronous vibrator or non-synchronous vibrator used in conjunction

with a tube rectifier are usual, used in conjunction with well-designed filter circuits that are quite efficient in keeping vibrator hash out of the set proper. Such a power supply is depicted in Fig. 6.

SHORTWAVE RECEPTION!

One of the foremost innovations of this year's "crop" of auto sets is the inclusion of shortwave reception in the custom-built sets made for Buick. In addition to the Domestic Broadcast Band they include several Shortwave Broadcast Bands for the reception of European Shortwave broadcasts.

In effect, several narrow Shortwave Bands have been added, and band-spread to cover entire dial tuning. This was necessary as it is illegal to own without a special permit a mobile receiver which tunes to the frequencies used by the police departments. The particular bands incorporated in the sets in mention are the 16-, 19-, 25- and 31-meter bands, all of which are necessary, to insure fairly consistent reception at any time of the day, due to the inconsistent and variable results experienced on individual channels in short-wave reception.

It is not to be assumed that these sets mark the introduction of shortwave inclusion as a regular feature of automobile radio receivers to come. Primarily these

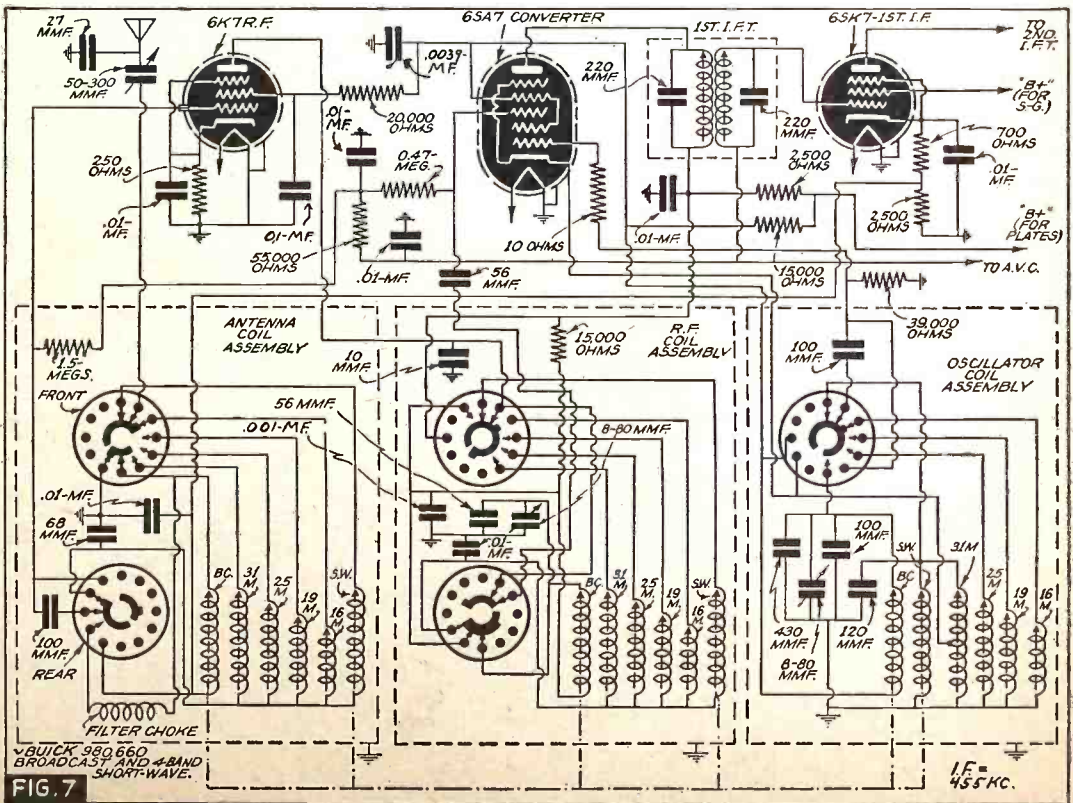
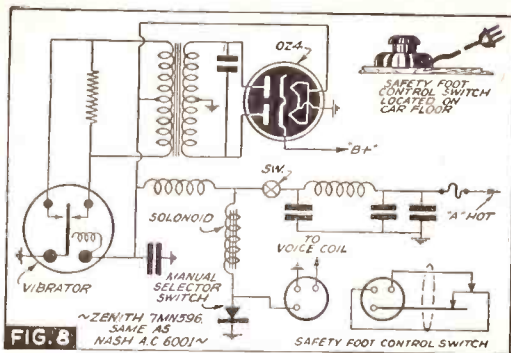

FIG. 7

IF = 455 KC.



shortwave bands are included for the car owner who drives in areas where daytime reception from broadcast stations is unsatisfactory because of distance. Shortwave reception, because of its far greater range is usually receivable in these areas. Incidentally such remote areas lack the local interference causes that make shortwave reception difficult in large cities. To doubly insure the latter, the sets include an automatic noise limiter of conventional pattern. (See Fig. 7.)

FOOT TUNING

No longer is it necessary for the driver to wait for a red light, to change the station. A device developed by Zenith and incorporated in the 1941 Nash cars uses a foot-controlled lever to change the station. This foot-controlled switch when partially depressed is a muting control, useful for momentary cessation of all sound from the radio as a convenience in conversation. When released, reception is resumed.

When the pedal is fully depressed, the

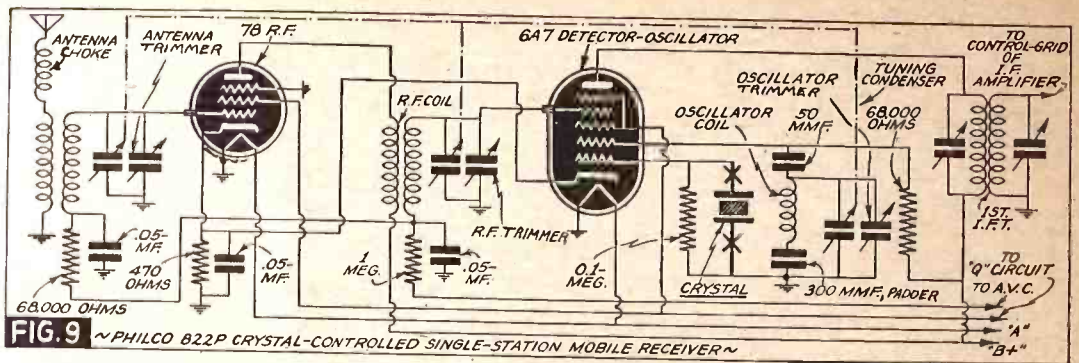

station is changed. A total of 5 such station changes can be made. The station selector switch is the usual arrangement of 5 separate, permeability-tuned circuits, a rotary switch operated by a solenoid being substituted for the usual pushbuttons. Closing the circuit by depressing the foot control rotates the selector one position so that the next circuit is chosen. (See Fig. 8.)

CRYSTAL CONTROL

The use of a quartz crystal to exactly maintain a given position in the frequency spectrum has been for some time an integral element in car-radio receivers designed for police use. The latest circuit arrangement of this type is shown in Fig. 9, which illustrates the Philco 822P receiver.

The 822P is a fixed-frequency set which tunes to the medium-high frequencies. These are the frequencies used by the Municipal Police, State Police, Marine Fire, Geophysical and Temporary Service, and the Forestry, Forest Fire Control, Flood Control, National Park Service, Coast Guard

Service, etc. (1,550 kc. to 3,600 kc.)

These sets are equipped with a special, high-impedance, universal antenna transformer, designed to operate at maximum efficiency on every recognized type of car aerial. Besides simplifying installation, this feature facilitates the interchange of radio sets for service, in cars equipped with a different kind of aerial. No aerial adjustment is required.

(These sets also include a "Q" circuit, not shown in the portion of the circuit reproduced here, for quiet operation during periods of non-reception of the carrier.)

The quartz crystal used to control the oscillator frequency is of the sealed type. This feature is generally considered indispensable in any fixed-frequency receiver used for emergency work.

Prospective buyers of auto-radio sets can look forward with confident enthusiasm to the enjoyable use of their new car-radio receiver. The manufacturers are offering much that is new and better to the buyers of "car radios."

Interference in Loop Circuits

WILLARD MOODY

THE General Electric H-77 uses a shielded loop, with no provision for tuning the loop to resonance at the high end of the band.

Apparently, designers thought the high Q of the low-resistance coil would ensure sufficient sharpness of tuning and that a trimmer condenser across the coil would be unnecessary. As a matter of fact, when tried, the condenser did not do much good because the loop still picked up the interfering signal of a powerful local station that obscured the signals of weaker stations in the vicinity of the high end of the dial scale. To get around this difficulty, ordinarily would merely require turning the loop on its axis, so that the minimum point of pick-up would be had. The field of the station was so high however, that this did no good, and in addition, the 2 stations lay in the same directive plane.

The problem was solved with the modification of the grid circuit as shown in Fig. 1. A small coil, taken from a defunct midget set, was inserted in place of the loop L1. This coil, wound with good wire of not-too-small diameter, was about 2½ x 1 in. in dia. Taking the band-width of the loop as the peak, resonance sloped gradually to zero at 1,370 and 1,400 kc. This meant a 20-kc. spread to the right on the dial and a 10-kc. spread to the left. Also, tuning in general was broad on the high end.

With the coil in the circuit, shunted by a 3-plate midget tuning condenser set at half capacity (about 7½ mmf.), turns were taken off the coil until resonance was found at 1,600 kilocycles, with the regular receiver tuning condenser set wide open. Then, watching the V.-T. voltmeter connected to

read the D.C. output of the diode detector the dip to either left or right away from central resonance could be seen.

The spread was 10 kilocycles either side of resonance at 1,380 kc. and dropped abruptly at either end. This indicated good selectivity but not side-band cutting, for the I.F. had been aligned for flat-top tuning 10 kc. wide. The band-width had been cut from a spread of 30 kc. to a spread of 20 kc. and there was negligible pick-up by the coil itself, since in comparison to the large dimensions of the loop the coil was relatively small. In

fact, no special wavetrap was now needed to eliminate the interference, but had one been necessary the installation would not have been complicated by the problem of direct pick-up by the coil, as had been the case where the loop was used and the direct pick-up could not be avoided.

Removing the adjustable tuning condenser from the circuit of B in Fig. 1 (the 3-plate unit of about 15 mmf., max.) was followed by the installation of a trimmer taken from an old I.F. transformer. This trimmer, mounted with a piece of cut bakelite, was connected across the midget receiver coil and used to tune the coil to resonance at the 1,600-kc. alignment frequency. The coil itself was mounted close to the receiver's regular tuning condenser; and short leads, that formerly had been long to the loop were direct to the coil, further increasing the sharpness of tuning.

A second possible method of dealing with single-frequency interference is shown in Fig. 2, where the L/C circuits acts as a serious opposition to the unwanted signal frequency. Attenuation of the signal is had, but there is no increase in selectivity otherwise. In some cases, the arrangement may have merit as a means of getting rid of a heterodyne or cross-modulation.

The L/C parallel circuit in series with the grid lead to the regular tuning arrangement permits reduction of interference by offering high impedance to the signal it is desired to attenuate. At resonance, Z is infinite. Either side of the tuning curve peak, Z decreases gradually, so that tuning C will vary the attenuation, allowing as much decrease in signal as is wanted.

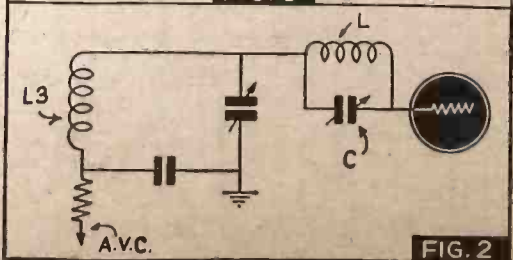
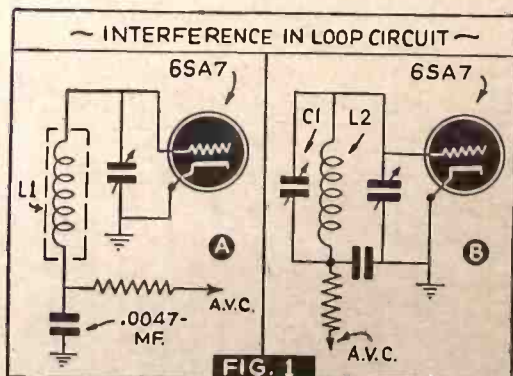

We're Goin' To Town

with HALLICRAFTERS

Used by 33
Governments
Sold in 89
Countries



Amateur testing and demonstrating room—
over 75 receivers on hand.



My office gang who help me
answer all mail, four swell girls.



Over half a mile of display like this—
hundreds of parts on hand.



SKY TRAVELER S-29

Only \$5.95 down. Take it on your vacation. Operates on self-contained batteries—110 V. AC/DC. 542 Kc.—30.5 Mc. Complete with battery and antenna \$59.50.

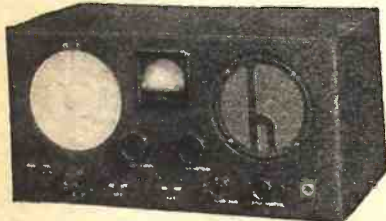

SKY BUDDY S19R

Own this fine business receiver. Only \$2.08 per mo. 545 Kc.—44 Mc. 6 tubes. Fits the small pocketbook. A most dependable receiver at low price of \$29.50.



SX24—\$6.95 down brings you performance compared with most receivers at twice the price. RF stage, good 10M operation, 9 tubes, crystal. Complete with tubes and crystal \$69.50. With PM 23 speaker \$81.50.

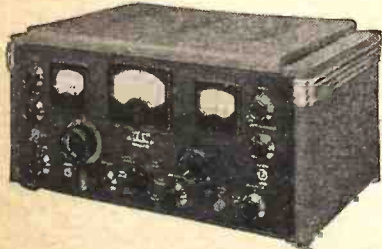

SX28—Takes only \$15.95 as down payment on one of finest receivers built. Designed for gov't specifications. 540 Kc.—40 Mc.

Features—15 tubes, 2 stages pre-selection, noise limiter, 6 step crystal selectivity, high fidelity audio.

WHOLESALE RADIO LABORATORIES is truly an amateur radio supply house. I ship to the four corners of the nation and even to foreign countries. I always keep a full line of stock on hand and can fill any order. The Welcome Mat is out. Look me up if you come through or near Council Bluffs.

73

LEO (W9GFQ)

WHOLESALE RADIO OFFERS YOU

- The lowest 6% plan available on any nationally known part, receiver or XMTR shown in any catalog or advertisement at the lowest price shown.
- A most complete stock of amateur needs on hand—parts, supplies, all receivers and XMTRS.
- Plus—trade-ins and cash offers on nationally known receivers or XMTRS.
- Prompt shipment of your orders—excellent shipping (8 trunk lines) facilities help me to send anything anywhere quickly.

Plus a genuine, friendly interest in your problems, careful attention to your orders—and always a reply to any and all your letters or cards.

WHERE CAN YOU BEAT IT?

FREE

Send for my big 3½ ft. x 4½ ft. two color amateur map. Shows radio zones, time zones, monitoring stations, principal cities. 15c to cover packing and postage brings one to you.

Get my big 124 page, fully illustrated bargain catalog. Contains many new and exclusive items. Shows my WRL 70 watt XMTR kit, selling at \$35.00.

I HAVE THEM ON HAND

I always carry a stock of Hallicrafters. A \$5.00 deposit brings one for 10 days free trial. If you like it, you can buy it on terms suitable to you.

If it's a dependable communications receiver you want—LET ME SEND A HALLICRAFTER.



One of my demonstrating booths.

WHOLESALE RADIO LABORATORIES

COUNCIL BLUFFS

"Everything for the Ham"

IOWA

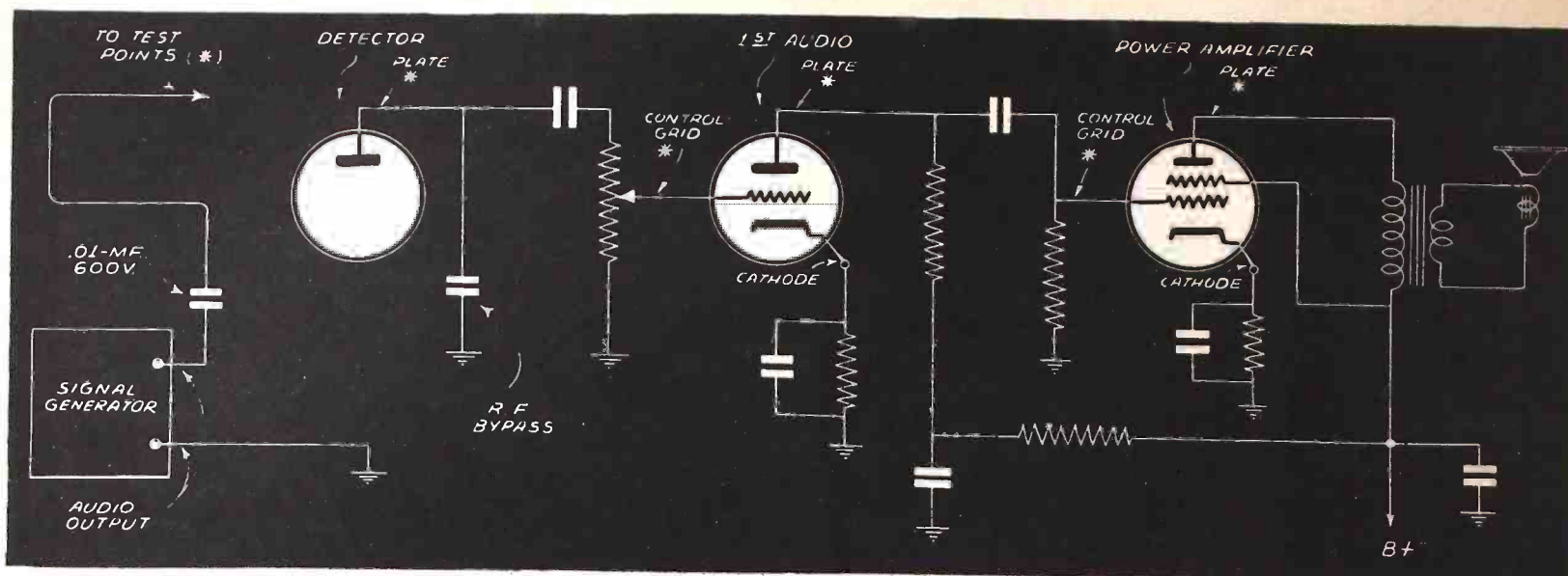

This illustration shows how the signal generator is connected to the receiver; asterisks (*) show where, in a representative circuit, the test prods make connection.

DYNAMIC TESTING WITH YOUR SIGNAL GENERATOR

The following article on the use of a standard signal generator in Dynamic Servicing supplements the numerous preceding Radio-Craft articles on this technique and is designed to show Servicemen how to quickly service radio receivers in minimum time and at least cost. Remember: "Time is money."

HERBERT S. HAYNES

MOST Servicemen realize the value of Dynamic Testing, but continue to service as before because they lack the "greenbacks" necessary to get the equipment needed.

To remedy this situation, *Radio-Craft* and other magazines have published less elaborate outfits that are supposed to do a satisfactory job of Dynamic Testing. Some of these outfits work fairly well, while others are not worth building. If you fellows can lay out enough to build or buy the better instruments, and if your business warrants such an investment, then go to it. On the other hand, you fellows who cannot see your way to add more equipment will doubtless be interested in knowing that *your signal generator can be used to do dynamic testing.*

PRELIMINARY TESTING

Assuming that we have a receiver to be serviced, our first step would be to check tubes. This would save time if as often is the case, there is an open or shorted tube. If the Serviceman prefers not to, tubes need not be checked.

Whether tubes are checked or not, the power supply should be checked with a multimeter. If voltages are incorrect, steps should be taken to correct them. Since all Servicemen are acquainted with power supply failures, nothing further need be said.

Having now found our power supply working properly we can begin dynamic testing. Note however that if the power supply is found defective, steps should be taken to correct it at once, to prevent further damage; and also because that may be all of the trouble with the receiver being serviced. All types of dynamic testing assume that the power supply has been checked before the dynamic testing begins.

AUDIO TESTING

Switching our signal generator to AUDIO OUTPUT, we ground one side of its output to receiver ground. A condenser of about 0.01-mf., rated at 600 working volts, should be inserted in series with the "high" side of the audio output lead from the generator. Note that the capacity of this condenser is not critical and is used only to keep plate voltage out of the generator attenuator circuit. In some generators this condenser is built into the instrument—if such is the case with your generator, no external condenser is needed.

First we feed a signal into the plate of the power amplifier tube and with the gain of the generator wide open we should hear a signal. If no signal is heard or is distorted it is only necessary that we check speaker, output transformer, and tone bypass condenser for defect.

Assuming signal was heard we now feed the signal into the control-grid of the power amplifier tube. The signal should now be louder. If no signal is heard, or if signal is weak or distorted the tube should be tested or replaced. If signal is still effected a multimeter check of this circuit will quickly disclose the defective part or parts.

If signal is heard the generator is then fed into the next audio plate, the next control-grid, etc., until all stages of audio have been found to be working properly. If signal is effected the tube in the offending circuit should be tested or replaced, if trouble still exists a multimeter check of the offending circuit will quickly disclose the defect.

Having now found our audio section working properly we feed an audio signal into the output of the 2nd-detector (or detector, if set is T.R.F.). If not heard, the coupling system between the 2nd-detector and 1st audio should be checked, also the R.F. bypass condenser.

DETECTOR

To test 2nd-detector we feed into the input circuit of the detector a modulated R.F. signal, tuned to resonance with the detector's tuned circuit. If no signal is heard the circuit should be checked with a multimeter.

Some generators do not have enough power output to get any audible response when fed into the circuit described above. If your generator does not, try using ear-phones as an indicator as they require much less driving power. In the case of diode detectors the signal may sound distorted. However, after you become acquainted with this type testing, you will know how the signal should sound, to be OK when the circuit is operating properly.

I.F. AMPLIFIER TESTING

Having found our 2nd-detector and A.F. sections working properly, we are now ready to test the intermediate frequency section of our receiver.

We adjust our generator for a modulated R.F. signal, grounding one side of its output to receiver ground. In the "high" side we insert a condenser in series, if no condenser is included within the instrument itself. With the generator tuned to the I.F. we feed a signal into the plate of the last I.F. amplifier tube, the control-grid, working back through all the stages of I.F. amplification. If the signal becomes effected, it is only necessary to test the circuit in which the signal is so effected, to determine the cause.

MIXER - OSCILLATOR

To determine whether the mixer (1st-detector) is passing a signal, a modulated R.F. signal tuned to the I.F. is fed into the input of the 1st-detector. If no signal is

heard a check of the circuit will disclose the trouble.

If a signal is heard, the generator should be switched to Broadcast Band (modulated R.F.), and tuned to resonance with the receiver. If no signal is heard the oscillator is not functioning. If the oscillator is found "dead," yet all voltages and parts are found in good condition, then irregardless of whether the tube tests good it is usually a good idea to replace it. A tube that will produce oscillation in some circuits will not necessarily cause oscillation in another. The receiver can now be tested at any frequency to determine if the oscillator goes out of oscillation. It is only necessary that the receiver and generator be tuned to resonance.

RADIO-FREQUENCY AMPLIFIERS

To test R.F. amplifiers the procedure is the same as for I.F. amplifiers; be sure, however, that the generator and the amplifier under test are both tuned to resonance.

CHECKING OF BYPASS CONDENSERS

To test a cathode bypass condenser in the A.F. section, feed an audio signal into the cathode. If the signal is heard, the condenser may be assumed to be defective. If no signal is heard and the condenser is known not to be shorted, then the condenser is operating properly. The effectiveness of any bypass condenser can be determined by feeding into the circuit a signal of the order it is required to bypass. Note however that in some circuits, although the circuit is functioning properly, a signal will be heard; experience will quickly teach you to recognize in what circuits to expect response, and how much.

CONCLUSION

This method of testing has proven quite helpful to me in my service work, and if you fellows will give it a try I am sure you will also find it helpful. This article is not intended to discourage the purchase of test equipment, but rather to aid the Serviceman who is financially unable to purchase more equipment. It is the hope of the author, that this type of testing will help the Serviceman who uses it, to do faster and better service work.

SERVICE SHORTS

Servicemen who attended a recent get-together of the Sylvania Service Schools, held for the Northwest group, experienced a new thrill. Chalk talks conducted in black-out fashion, on blackboards, were easily readable by the entire assemblage. The secret? A fluorescent material in the chalk became brightly illuminated when influenced by ultraviolet lamps.

Here's the latest development in wired-radio: according to Westinghouse engineers, a dial telephone system has been developed for inter-connecting any combination of 10 telephones at either end of a pair of high-voltage power transmission lines up to 400 miles apart. Voice-operated relays set the distant station equipment in operation within 9/1,000-second!

RE: "EXPERIENCES WITH METAL-TREASURE LOCATORS"

Despite the fact that every effort was made to include the above-titled article in this issue, unexpected conditions made it impossible. We are very sorry this occurred, but this article certainly will appear in the August issue. Meanwhile, you're all welcome to write-in for our free list of previously-published articles on Metal-Treasure Locators.

1942? FACTS About Next Year's Models!

FACT 1. It takes a long time to build a really GOOD test instrument—to get the "bugs" out—to prove, and improve, its performance and reliability. Then—when it's REALLY good—why change?

FACT 2. Today's SUPREME Instruments are as modern, as accurate, as dependable as test equipment can be built.

FACT 3. That is because SUPREME believes in, and practices, a policy of continuous improvement instead of just "putting a new coat of paint on an old chassis."

FACT 4. A new SUPREME model is never announced until progress in radio has developed a definite need for such an instrument.

FACT 5. Therefore, SUPREME will announce NO "new" models at the June radio show. Which proves that SUPREME Engineers know their business—that they know, and are guided by, YOUR requirements.

FACT 6. SUPREME Test Equipment for 1942 will be as it is now, your best buy, and "SUPREME BY COMPARISON!"

Write for SUPREME'S current catalog. It pictures and describes the instruments your Jobber has in stock NOW—for 1942. Due to present conditions, prices and prompt delivery guaranteed only until June 1st.

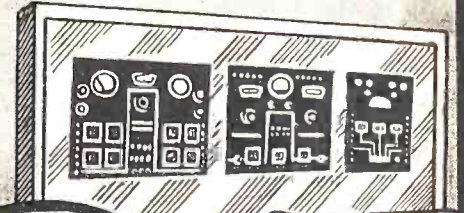

—and they'll be just as good next year as this!

JOE'S RADIO SERVICE

Still time to get your new SUPREME Book explaining a new servicing procedure that makes an ailing radio talk to you like a patient talks to his doctor. Only 35c to cover cost of printing and mailing.

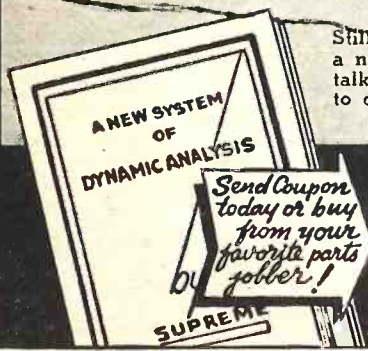

SUPREME Instruments Corp., Dept. RC2, Greenwood, Miss. Gentlemen: I enclose 35c. Please send me your new book referred to above.

NAME.....
ADDRESS.....
CITY..... STATE.....

The Most Complete and Authentic P.A. Book Published—AMPLIFIER HANDBOOK AND PUBLIC ADDRESS GUIDE—only 25c. See Page 8.

Simplest WAY TO REPLACE BALLASTS

4 STANDARD TYPES of Amperite Regulators replace over 200 types of AC-DC Ballast Tubes now in use. . . . Has patented automatic starting resistor. List \$1.00

WRITE FOR REPLACEMENT CHART "S" Amperite Co. 561 Broadway, N. Y. C.

AMPERITE

Home Recorder FREE!

PUT THIS NEW 1941 **15-TUBE RADIO-PHONO** CHASSIS IN YOUR PRESENT CABINET

25 TRADE-IN (on Many Models up to 16 Tubes)

ONLY **\$22.50** COMPLETE RADIO-PHONO CHASSIS with TUBES and SPEAKER

30 DAYS TRIAL

HOME RECORDER FREE

E-Z TERMS CATALOG FREE

MIDWEST RADIO CORPORATION DEPT. 12-A CINCINNATI, OHIO

Radio Service Data Sheet

ZENITH MODEL 4K600 "POKETRADIO" (Chassis 4B01)

4-Tube Superhet.; 2.4 V. Miniature Tubes, Built-in "Wave Magnet" Loop Antenna; Automatic On-Off Switch; Permeability-tuned I.F.s; 3 1/2-in. P.M. Dynamic Speaker; Range 540-1,600 kc.; Lightweight (4 lbs., 9 ozs. with Batteries); Automatic Volume Control; Size 3 3/8 x 4 1/4 x 7 3/16 ins.

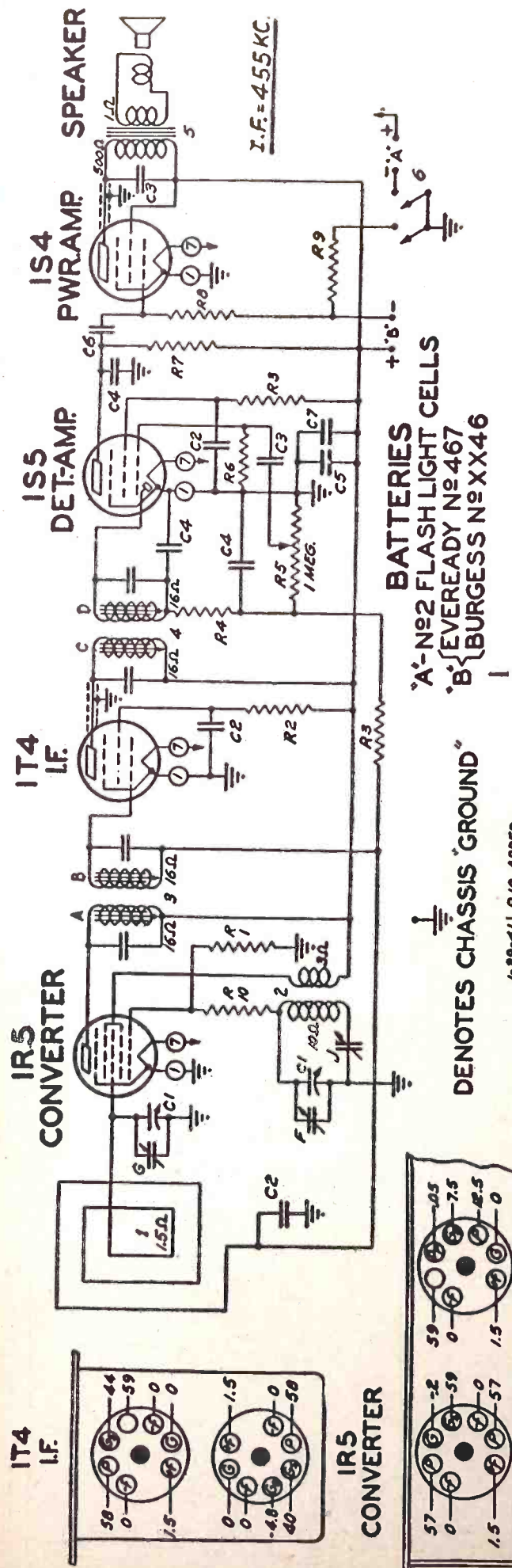

DIAG. NO.	PART NO.	DESCRIPTION	DIAG. NO.	PART NO.	DESCRIPTION
C1	22-167	TWO GANG VARIABLE	R3	63-724	47 MEGOHM
C2	22-174	.01 MFD.	R4	63-713	47M OHM
C3	22-169	.001 MFD.	R5	63-1176	VOLUME CONTROL
C4	22-162	.0001 MFD.	R6	63-1093	15 MEGOHM
C5	22-176	5MFD-ELECTROLYTIC	R7	63-464	1 MEGOHM
C6	22-175	.005 MFD.	R8	63-723	33 MEGOHM
C7	22-189	.05 MFD.	R9	63-729	680 OHM
R1	63-715	100 M OHM	R10	63-1234	680 OHM
R2	63-765	33M OHM			WAVEMAGNET ASSEMBLY
					OSC. COIL ASSEMBLY
					1ET I.F. TRANS.

1-29-41 R10 ADDED

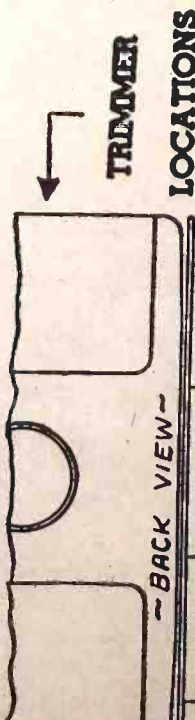
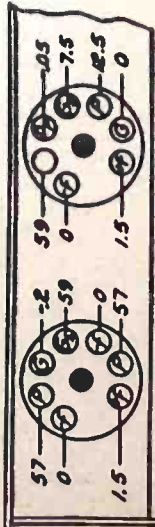

tain actual shielding capacities during the balancing operations.
 Remove back of receiver.
 Remove "B" batteries.
 Remove case of receiver.
 To remove case: first place receiver on bench with lid down, then place screw driver under spring clips and pry up, at the same time pulling case away from chassis. After spring clips have been released the case can be lifted off chassis. Next remove clips by turning, and pulling away from chassis. Do not remove "A" cells.
 Connect one lead from the output meter to the bare jumper connecting the plates of the output tube (IS4) and the other output meter lead to "B+" at the battery (blue wire). CAUTION—Keep signal from generator at minimum so A.V.C. action will not give a false peak.

All voltages shown above are measured with a 20,000 ohms/volt meter from chassis to socket contact indicated. All voltages are positive D.C. unless marked otherwise. Volume control full on. Battery voltage 67.5 volt "B"; two 1.5 volt "A" cells. Power output, 0.160-watt. Tuning ranges, 540 kc. to 1,620 kc.

Stage Gains:
 Broadcast and 455 kc. I.F. Loop to converter grid down 1/3 X at 1,000 kc. Converter grid to I.F. grid 49 X at 455 kc. Overall audio 317 X at 0.5-watt, 400 cycles.

ALIGNMENT PROCEDURE
 The following Alignment Procedure on Model 4K600 "Pocketradio" must be carefully followed using a No. MS-652 Zenith Alignment Jig to main-

Operation	Connect Test Oscillator to Converter Grid	Dummy Antenna	Input Signal Frequency	Band	Set Dial	Trimmers	Purpose
1	1	0.1-mf.	455 Kc.	—	1,600 Kc.	A, B, C, D	Align I.F.
2	2	—	1,600 Kc.	—	1,600 Kc.	F	Set Oscillator to Scale
3	3	—	600 Kc.	—	600 Kc.	J	Rock Gang and Adjust for Max.
4	4	—	1,400 Kc.	—	1,400 Kc.	G	Align Antenna



Zenith "Pocketradio." Tuning range: 540-1,600 kc. This portable, using miniature tubes, weighs under 5 lbs., complete.

Radio Service Data Sheet

CROSLY MODEL 45BV "COMMUTER"

4-Tube Superhet.; Battery Portable; Miniature 1.4 V. Tubes; A.V.C.; Built-In Loop Antenna; Range—550 to 1620 kc.; P.M. Dynamic Speaker; Automatic "On-off" Switch.

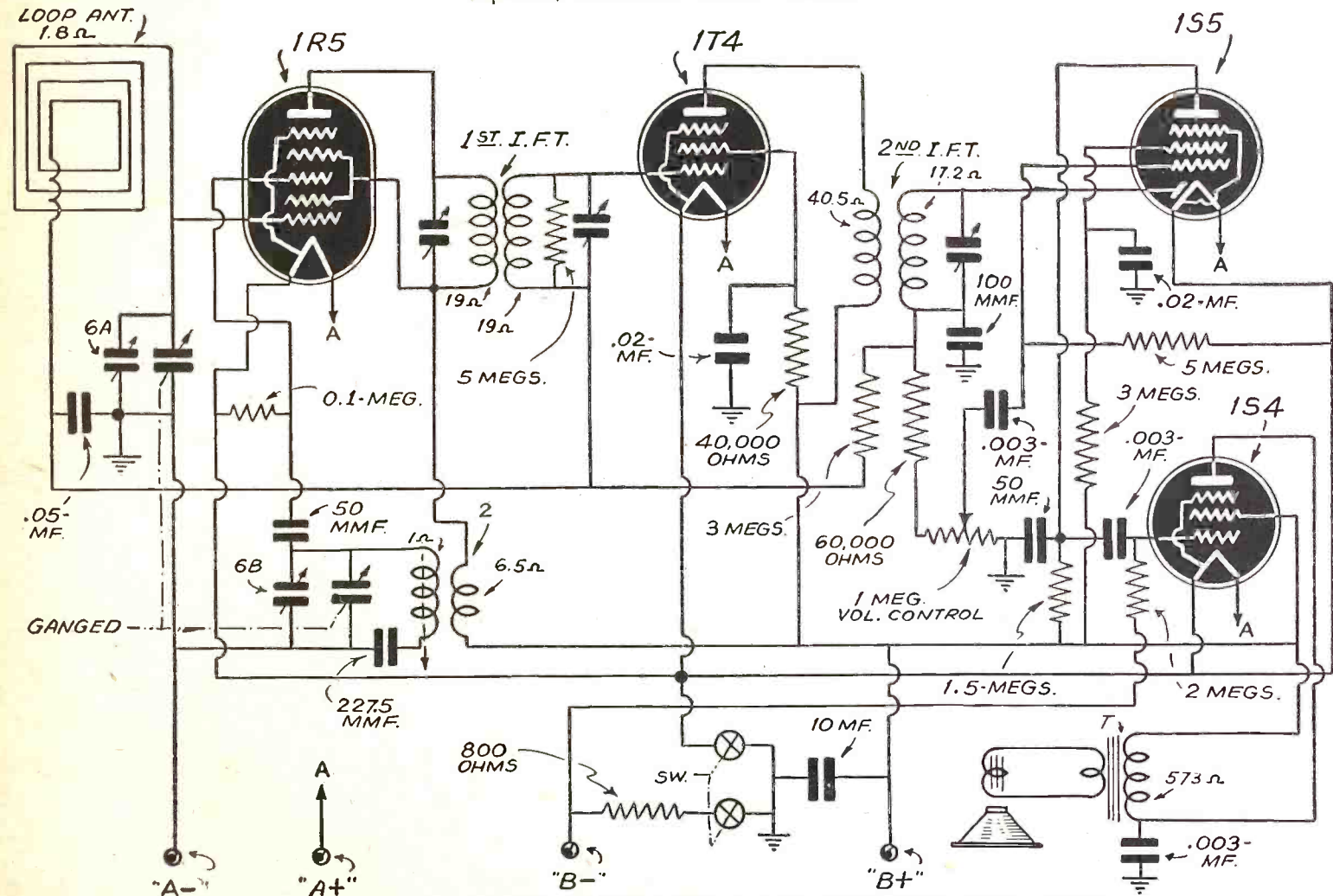

Complete schematic diagram of the Crosley Model 45BV—4 tube superheterodyne battery portable.

BATTERIES REQUIRED—1 Eveready No. 950 size "D", 1.5 volt "A" cell, or equivalent; 1 Eveready No. 467 Minimax 67½ Volt "B" battery, or equivalent.

INSTALLING BATTERIES—Push small recessed button (located on top side of case) toward other end of slot. Carefully remove the rear half of case by opening at catch side first and unhooking at bottom. Carefully place "A" cell (flashlight cell) in position by pushing in and raising clamp. Insert "A" cell top down, and close the clamp.

Place the "B" battery approximately in position with the connections toward the coil and away from the tubes. Snap the 2 buttons on corresponding battery connections. The yellow lead to bottom battery connection and the red lead to top battery connection.

REMEMBER—ALWAYS REMOVE BATTERIES FROM CASE WHEN USEFUL LIFE IS EXHAUSTED. NEVER LEAVE DEAD BATTERIES IN CASE AS DEAD BATTERIES DETERIORATE AND SWELL, SPILLING CORROSIVE ACIDS OVER ADJACENT PARTS. When replacing back cover hook lower end first and carefully close. Remove tubes with exceptional care.

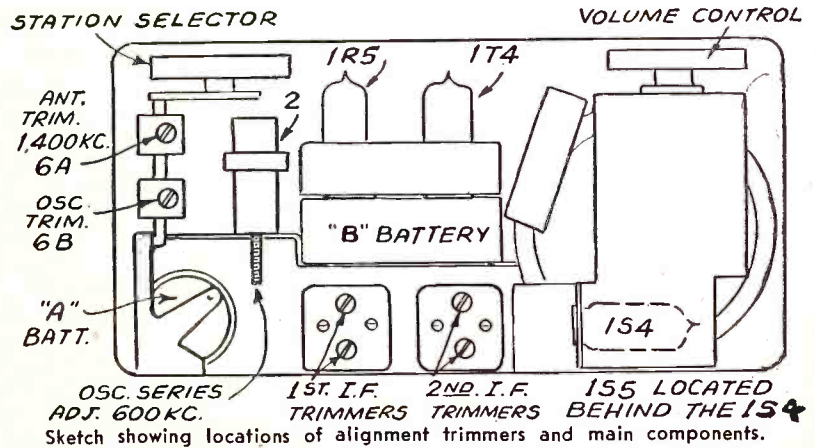

SOCKET VOLTAGES

Measured from socket contact to chassis ground using 10-V. range (for filament) and 500-V. range (for plate and screen-grid) of a 100,000 ohms/volt meter.

TUBE FUNCTION	No. 1	No. 2	No. 3	No. 4	No. 5	No. 6	No. 7
1R5 Osc.-Mod.	Gnd.	51	51	—	—	—	1.3
1T4 I.F. Amp.	Gnd.	51	33	—	—	—	1.3
1S5 Det.—A.V.C. 1st A.F.	Gnd.	—	—	5	5	—	1.3
1S4 Pwr. Output	Gnd.	51	*7.9	51	—	—	1.3

*Measured across item 21, an 800 ohm resistor. "A" battery drain approximately 250 ma. "B" battery drain @ 58.9 Volts approximately 9.2 ma.

Step	Signal Dummy Antenna	Generator Frequency Setting	Input to Receiver	Tuning Cond. Setting	Trimmers Adjusted	Remarks
1.	02.	455 Kc.	Stator of top section of gang	Fully open	2nd I.F. (2) 1st I.F. (2)	Adjust for max. output. Adjust for max. output.
2.	None	1,620 Kc.	Signal radiated by loop on generator	Fully open	"OSC" Trimmer	Adjust for peak gang; does not have to tune through signal.
3.	None	1,400 Kc.	"	Approx. 140 on dial knob	"ANT" Trimmer	Adjust for max. output
4.	None	600 Kc.	"	Approx. 60 on dial knob	Iron core in osc. coil	Adjust for max. output while rocking gang through signal.
5.	REPEAT THE ABOVE ALIGNMENT PROCEDURE TO INSURE ACCURATE ADJUSTMENTS.					

ALIGNMENT PROCEDURE

Preliminary: Output meter connections, plate to screen-grid of 1S4; generator ground connection, to chassis; dummy antenna to be in series with generator output, see chart above; Position of volume control, fully on.

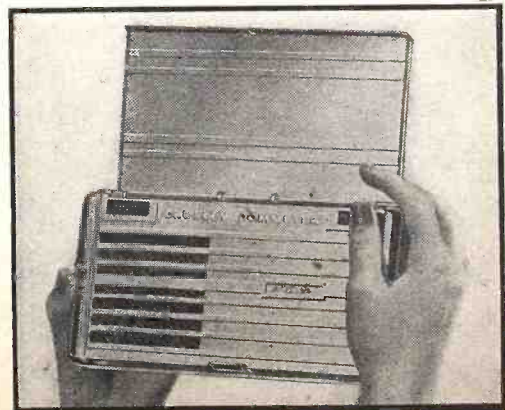

Crosley Model 45BV "Commuter."

SERVICING

Last month Mr. Shunaman told Radio-Craft readers something of the problems the radio Serviceman in China encounters in setting up and operating a service business among the Shanghaianders. This month, he interestingly discusses specific problems peculiar to radio service in the Orient, and how these problems were solved.

Map of Shanghai showing voltage distribution. Cross-hatched are the areas where unexpected voltages are sometimes encountered. Hongkew and West Hongkew, part of the International Settlement or "Englishtown," are under control of the Japanese army. The "bad lands" are under very little control of any kind.

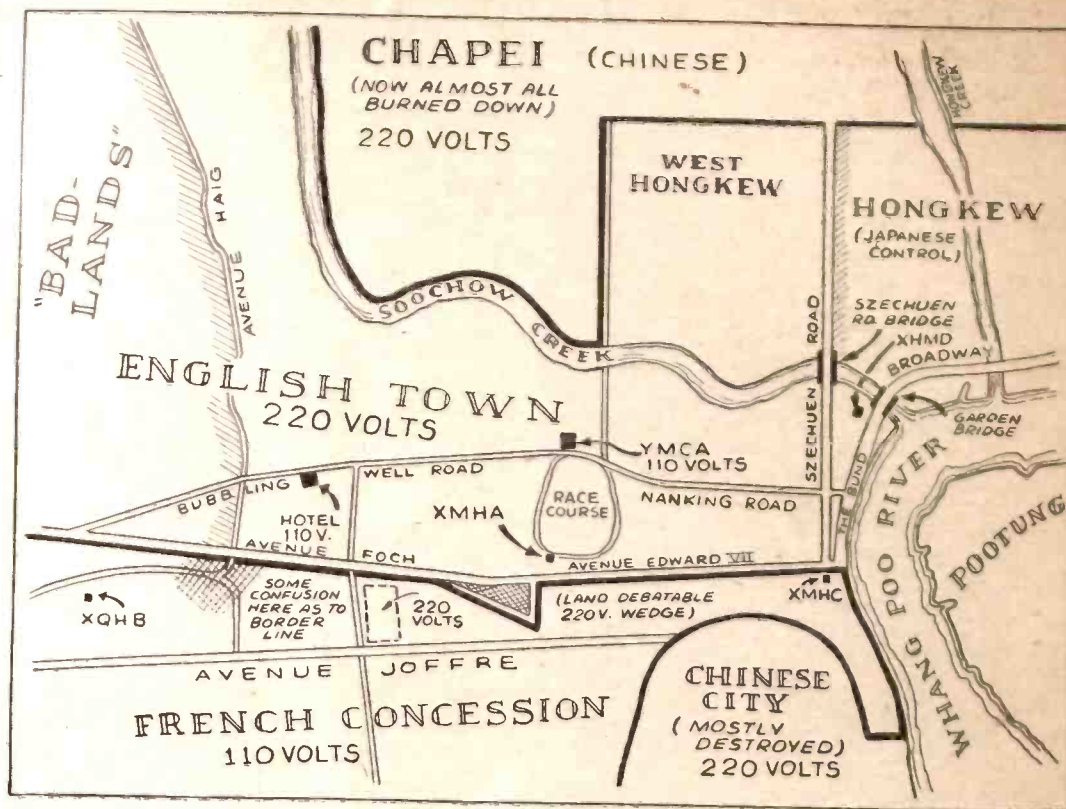

RADIO REPAIR—CHINA STYLE

FRED. SHUNAMAN

Recently of Shanghai, China

GETTING a busted radio back to work is essentially the same job whether performed in Shanghai or St. Louis, but local conditions sometimes give rise to unique angles. Some of the things we do in China are (I hope!) entirely new to the American Serviceman; a few will sound vaguely familiar to our brothers in remote parts of the West, who sometimes feel they might as well be in China, at least as far as getting replacements is concerned.

The first thing to strike the visiting radioman is the variety of stuff used here. The greater part of the sets are American, but the rest come from all corners of the earth. Hookups for American receivers are obtainable; European manufacturers guard their schematics like military secrets. Add that these sets use circuits unknown in America, and that usually 2 or 3 "Servicemen" have mulled over them before they come into the shop, and you have an occasional problem.

PHILIPS—A PROBLEM JOB

One of my worst was an old Philips 2-band R.F. job. The old Philips are particularly tough because both coils and condensers are soldered up in copper shield cans in

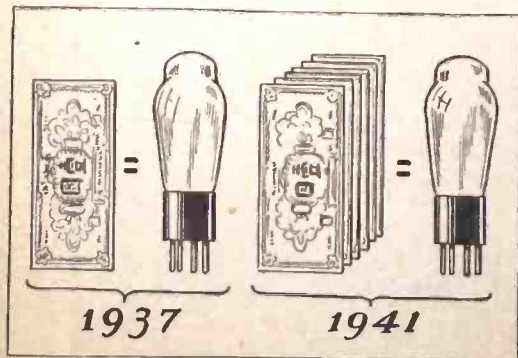

Comparisons between the Chinese dollar bill and the vacuum tube in the illustration show what has happened to the cost of radio parts as a result of the undeclared war.

such a way that tracing circuits is almost impossible.

We replaced a couple of nearly dead tubes (the only obvious defect), and turned on the set. Nothing happened. Several hours of heavy thought and experiment, mixed with pure guessing, followed. Finally we found that the owner, who was a bit of an amateur Serviceman himself, had shifted the triode detector into the 1st R.F. and put one of the tetrodes into the detector socket. The leads to the tube-caps were so laid out that nothing seemed out of the way in this arrangement.

The tubes were straightened out, but still nothing happened. A little mixed music came through, but there was no tuning whatever. It became apparent that there must be an open in the variable condenser leads. Visual inspection showed everything outside the condenser cans OK, so there seemed nothing for it but take out the gang, sweat off the cans, and find the open.

I started out in the face of warnings from my Serviceman, who assured me the stuff was put together with the express purpose of preventing anyone from meddling with it. But as soon as the soldering iron touched the first connection, a thick cloud of choking black smoke rose from the "connection" and the job was done. The owner-repairman had—for reasons best known to himself—unsoldered the stator leads and had "resoldered" them with a well-known "cold solder" which looks exactly like the real thing but is actually a celluloid compound, blood-brother to airplane dope and similar insulating compounds. (I tried a bit of it later—the resistance was infinite at the smallest distance I could separate the test-prods!) A thorough cleaning-up and resoldering of these leads brought the radio set back to earth again.

ASSORTED LINE VOLTAGES!

Not only do receivers and their owners get our goats, but even the power supply

puts in a bit of deadly work now and then. Shanghai is a city of 2 voltages. The International Settlement uses 220; the French Concession 110.

There are a few islands in each area where building owners have installed substations to jump the voltage up or down to suit their own equipment, so there is always a delightful chance of putting a 110-volt set across 220. (This furnishes us with a worthwhile part of our business.) I blew out a set in a building I knew to be 110-volt. The thing I didn't know was that the customer had installed a transformer for his apartment only! The power supply was again the villain in the case we called . . .

... "THE PHILCO THAT WENT TO BED EARLY"

This was a small super. with nothing much wrong but a few tubes and a pair of filter condensers "out." We got a call-back and complaint of "fading" a few days after sending it home. Sent a man over. He reported the set OK. Two days later another call came in. The Serviceman was told to bring in the set if there was nothing obviously wrong. We checked it over, played it 2 days continuously on the bench, and sent it back again. When the Serviceman came back this time, he had some information. "Funny thing" he remarked, "they say it always plays all right in the day time."

I made an appointment to see this remarkable set the same evening. Arriving about 7 o'clock, I plugged an A.C. voltmeter into a handy receptacle and sat down to wait for results. The owner's brother-in-law brought a bottle of beer to help lighten the vigil, and together we watched the meter and listened to the program. The one dropped—sometimes in steps of 5 volts at a time—while the other weakened and weakened, but gamely kept up the struggle, I had to leave at 8 o'clock, at which time the voltage was 60—and the set was still playing! (They told me it quit at 8.30.)

This condition was due to the enormous overcrowding of the foreign areas by refugees from the war zone, and the only repair measure was to write the French power company about it. They didn't like the unprofitable situation any more than did the Philco, and put in new feeders all up and down the street.

EXCHANGE

International finance also plays its part in bedeviling the situation. The Chinese dollar was worth 33c U.S. before the war. It is now worth less than 6c. Wages in Chinese money went up slowly—prices on radio parts followed the American dollar, and for the past year have been quoted in American money. The effect has been to raise the price of radio repairs beyond all reason. A customer may find that a repair will cost him more than the original price of his set! Naturally he is outraged, and in many cases actually unable to have the job done.

While the slipping exchange makes it harder to sell our service, it gives us trouble getting replacements. Wholesalers are unwilling to do business, and jack-up even the U.S.-money prices. Sales resistance is all on the sellers' side. They would rather keep their excellent goods than have your dubious money!

This high cost of parts—particularly European components and parts stocked especially for a given make—sometimes makes repair of a set impractical. One American concern even went to the extent of bootlegging their own stuff. Their replacement parts were sold at the American catalog list, at least 5 times as high as the Shanghai market price on the same items. When they had a job they used to sneak out and buy a volume control or electrolytic, doing the whole job at a price well below what the part alone would have cost, had they used their own stuff.

A German radio receiver came in with 2 tubes "dead." Replacing them would have cost nearly as much as a new American midget, but after listening to the tone quality of a couple of them she begged us to "do something" about her old set. A pair of American tubes were installed, an auto-transformer wound on an old audio transformer core to raise the 4 volts of the filament circuit to 6.3 V. for these 2 tubes alone, and the whole thing went off beautifully at about one-third the cost of replacing the dead tubes. (See diagram.) In other cases we have "tailored" additional turns onto the rectifier winding, to bring up its 4 V. to 5 for an 80-type tube, which is cheaper and more rugged than most equivalent European rectifiers.

"CHINESE COPIES"

As a partial relief for the parts problem, many components are now being turned out locally. Paper condensers made here are preferred to the imported ones. Audio parts,

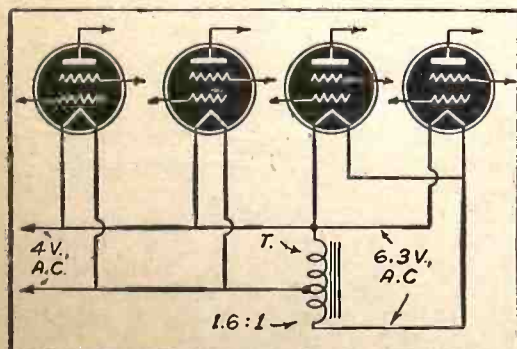

How the Telefunken set problem was tamed. The autotransformer T. was made from the core of an old A.F. unit (3/4-in. cross-section—7/8 x 7/8 in., window, wound with 64 T. of No. 21 B. & S. gauge copper wire and tapped at the 40th turn for 4 V.).

Differing Only in Size and Price!

WESTON
Pocket Size
TEST INSTRUMENTS

WESTON ELECTRICAL INSTRUMENT CORPORATION
 599 FRELINGHUYSEN AVENUE, NEWARK, NEW JERSEY

No need to sacrifice dependability when seeking the convenience which pocket-size instruments afford. For this series of WESTONS . . . while truly compact in size and low in initial cost . . . provide the dependability and long life which are typically WESTON. In addition, they are versatile instruments; Model 697, for example, providing the necessary voltage, current and resistance ranges for efficient trouble-shooting. Let us send you full particulars on these convenient, low-cost instruments. Write today.

I.F. transformers and loudspeakers have been made here for some time, and someone is always trying unsuccessfully to make resistors and electrolytic condensers. One locally-manufactured set is, with the exception of tubes, fixed resistors and filter condensers, entirely the manufacturer's own product. *There will be an excellent opportunity for a tube manufacturer here after the war.*

In other cases it is not cost but absolute irreplaceability of parts that drive us to repair, construct or substitute them on the job. The dual volume controls on certain English sets give us some of our worst moments. These are 2 concentric units, the inside member of which is always the one to give out. We have to fasten a flat-type volume control to the rear end of the old control's shaft so they both turn at once. There are several variations on this theme, depending on the type of control and the amount of space in the set.

Transformers are rewound; almost never replaced. We believe our transformers to be superior to the manufacturers' jobs, as we keep in mind the super-humid conditions they have to work in and never use the moisture-absorbing cardboard forms and fibre sheets of the originals.

The I.F. and R.F. coils must also be rewound. Difficulties begin when we run into European coils intentionally crimped together so that Servicemen cannot meddle with them. I have seen these taken apart with a can-opener and replaced in a can from an old 8-mf. electrolytic.

The most exacting jobs are phono pickups. These are wound with No. 42 or smaller wire, and it is rare that one is rewound on the 3rd or 4th attempt. Once successfully re-installed and re-dampened with gum rub-

ber they are as good as the day they came from the factory.

Hearing-aids were often tough propositions, because of the special parts used. One missionary came to the city to attend a convention. He had an old English device which used a 2-volt storage cell less than 2 ins. square. The cell had been broken or lost, the "B's" were dead, and could we do something inexpensive about it, as he had a new one coming within a week?

We sent him to the meeting with a standard 40-amp.-hour glass storage cell, which he carried like a milk pail. The 3/4-A. tubes of his apparatus made anything smaller impractical. There was room in the set for a small 45-volt "B" battery, happily available on account of the portables just coming into use. He was thoroughly satisfied with the arrangement, and brought his new American hearing-aid for us to look at, the next week. We were able to refer him to an outfit trying to make batteries for the portables, and shortly afterward he showed me Shanghai duplicates of the extremely compact "A" and "B" batteries of his new hearing-aid!

"... IT'S THE HUMIDITY"

Humidity is the evil spirit hovering over Shanghai "radios." Always higher than the American extreme, it is aggravated by the tropical typhoons. After 3 days of rain and gale, during which it is sometimes hard to distinguish between air and water, the humidity goes up to more than 100%, and little pools appear unexpectedly in cool corners of the shop.

Paper and unimpregnated fibre in transformers take their share, and if sets are not used continuously, transformers go up in a

BIG BOY

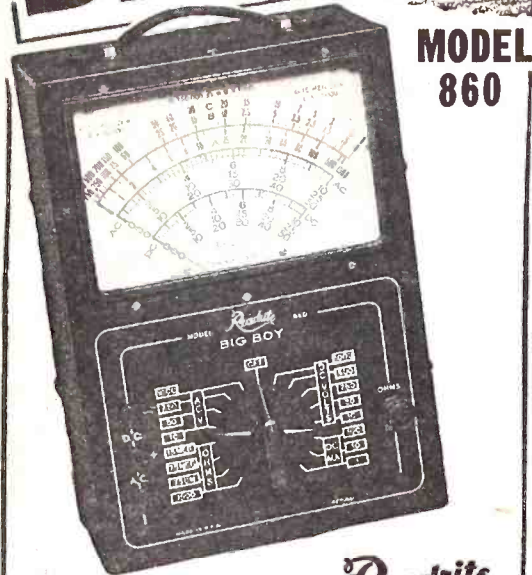

MODEL 860

Performance . . . Eye Appeal . . . Value . . . Sensationally Priced at \$19.65, Dealer Net Price.



Here is an AC-DC Volt-Ohm-Milliammeter with all the ranges you want . . . easily readable on the large 7" instrument with extra-long 6" scale, in a new up-to-the-minute three-tone case. DC Volts 0-10-50-250-500-1000 at 5000 Ohms per volt DC; 1000 ohms per volt AC. AC Volts 0-10-50-250-1000 at 400 ohms per volt; DC Ma. 0-1-10-100; Resistance ranges; 0-1500 Low Ohms; 0-150,000 Ohms and 0-7.5 and 0-15 Megohms. Maroon case with red and silver panel, attached handle. Dealer Net Price, \$19.65

See the new 1941-42 line of Readrite Meters and Testers in Booth 725—Chicago Radio Parts Show

For Catalog Write—Section 716, College Drive

READRITE METER WORKS, Bluffton, Ohio



SERVES THE SERVICES

Solar is proud of . . . and is zealously guarding . . . the reliability which its Capacitors add to radio and electrical control equipment for the Armed Service Branches of our Government. Solar reliability is built into all types of electrical condensers for industrial, radio and service applications.

SOLAR Mfg. Corp. Bayonne, N. J.

FIX ANY RADIO

Amazing New Invention

Simplified Radio Servicing by Comparison Method

Repair radios in minutes instead of hours. Revolutionary different comparison technique. Permits you to do expert work immediately. Most repairs can be made without test equipment. Simple, point-to-point, cross-reference, circuit suggestions locate the fault instantly. Plan copyrighted. Covers every radio set—new and old.

Complete \$1 Training

In Manual form, 8 1/2 x 11 in., 112 pages. Over 1,000 practical service hints, 18 large trouble-shooting blue-prints, 114 different tests using a 5c resistor. Invented by M. N. Beitman, noted engineer and radio teacher. SUPREME PUBLICATIONS, Room 1057 3727 West 13th Street Chicago, Illinois

Results and Satisfaction Guaranteed. The complete simplified training is yours for only \$1.00, postpaid. Will pay for itself with time saved on the first job. Limited quantity. Money-back guaranteed. Write today.



FREE! RADOLEK'S 1941 RADIO PROFIT GUIDE

Everything New in Radio at Bargain Prices! Radio parts—Sets—Accessories—Ham gear—Electric appliances and supplies—Public Address Systems. Don't Wait—Send for the Big FREE Radolek Profit Guide Now! Save Money at Radolek.

RADOLEK CO., Dept. C-56 601 W. Randolph St., Chicago, Ill.

cloud of mixed steam and smoke a few minutes after being turned on. The dampness has a bad effect on all fine windings, and it seems that condensers also have a habit of "going out" in times of high humidity. This makes for spotty work. Most of the sets in town are on the bench the day after a typhoon, and we work overtime for a week. Then there is a 2-week lull during which little or nothing comes in.

The work here is often annoying—sometimes nerve-wracking—but there is a thrill

of accomplishment in constructing an impossible part and putting it into an impossible place; this is absolutely unknown to the Serviceman who selects the correct replacement by part number and solders it mechanically into place, never doubting that it will start right off and work normally. I sometimes fear that a few years of it would spoil any repairman, and that I could never again be happy in a shop where all the replacements are the same size as the parts taken out.

ELIMINATING IGNITION INTERFERENCE In Car-Radio Installations

AFTER a car-radio set has been correctly installed, the suppression material packed with the receiver should be applied as outlined in the Installation Instructions. Be sure to follow the Installation Instructions in detail, since all the steps are of the utmost importance in eliminating ignition interference.

If after all these operations have been completed, there still is ignition interference, the following additional operations may prove helpful.

Disconnect the aerial lead from the radio set. All ignition interference which is heard is called "Radio Chassis Pick-up."

1. Shield the "A" lead on the radio-set housing and ground the shielding near the point where the "A" lead enters the radio receiver. Be sure the shielding does not touch other wiring in the car and that it is dressed on the side of the receiver.
2. Dress all ignition wires as far away from the set as possible.
3. It may be necessary to add a 1/2-mf. condenser in the radio set. One side of the condenser should be connected to the "A" terminal where the "A" lead enters the receiver and the other end of the condenser must be grounded to the radio-set housing.
4. Particular attention should be given to bonding all the controls which pass through the dash. These operations should eliminate "Radio Chassis Pick-up".

Connect the aerial lead to the radio set. All ignition interference which is heard is called "Aerial Pick-up".

1. Slide the clip of the aerial lead either up or down on the rod and fasten in position where the least amount of interference is heard. Dress the aerial lead above the ignition lock.
2. An additional pigtail connected to the shield in the center of the aerial lead and grounding the pigtail may reduce the interference.
3. Connect a piece of copper braid from the

ground side of the battery to the motor block. The right mounting bolt of the oil filter forms a convenient point to locate this ground to the block.

4. It may prove helpful to connect an additional 1/2-mf. condenser to the ignition switch.
5. In some stubborn cases it may be necessary to peen the rotor.
6. In many cases isolating the wire which is connected between the ignition coil and the terminal on the overdrive transmission has proven helpful. Disconnect and tape up both ends of this wire. Connect a shielded wire from the ignition coil to the terminal on the overdrive transmission. The shielded wire should follow the speedometer cable all the way down to the terminal on the transmission. Ground one end of the shielding near the overdrive terminal and the other end of the shielding near the ignition coil-terminal.
7. The side panel is fastened at the cowl to an angle bracket with one hex-head bolt and one round-head screw. Raise the hood and remove the bolt and screw that fastens the left-side panel. Clean all the paint from the bracket underneath the bolt and screw heads to insure good electrical contact and then replace the bolt and screw.
8. In some cases of severe motor interference, it may be necessary to ground the gear shift and steering columns in the motor compartment at the point where they enter the body. The ground strap should be made from heavy copper braid and should be 4 1/2 ins. long. Solder one end of the strap to the both columns and the other end of the strap to the dash. There should be sufficient slack in the ground strap to permit free operation of the gear shift.

If these operations do not reduce the interference, it may be necessary to use sparkplug resistors.

Philco Radio & Television Corp.

HOW HIGH THE CLOUDS?

The U. S. Weather Bureau and the Bureau of Standards have put their heads together and come up with a new wrinkle for measuring the height of clouds. Not content with the earlier schemes which utilized "radiosondes" or high-flying, balloon-borne radio transmitters, BUSTAN engineers have devised for the Weather Man a cloud-height measuring system which utilizes 2 directional photoelectric cells to pick-up the slight amount of light, reflected from the clouds by intense lightbeams directed them. By usual triangulation, the exact height of the light-reflecting clouds is easily determined.

RADIO SUPER-BRAIN!

Danton Walker, in his column, "Broadway," one day last month itemed that a Long Island munitions manufacturer is turning out something really new in radio remote control devices. A gun that automatically tunes to the vibrations (presumably wavelength) of an individual, but which doesn't discharge unless this wavelength is that of an "enemy." Looks as though the old guards' salutation, "Who goes there? Friend or foe?" is now outmoded by a robot device that all but reads one's mind. Just too bad, though, if a fellow momentarily slides off his own and into an "enemy" wavelength!

An Engineer Analyzes the

HOW and WHY of FREQUENCY MODULATION

By special permission of the Association of Technicians, Radio-Craft here presents an article on F.M., from the A.T.E. Journal, which covers the engineering aspects of Frequency Modulation more completely than any previously published in Radio-Craft, and does it in a thoroughly understandable manner. Part I, presented here, generalizes on the topic and discusses the results of measurements made on the transmissions of N.B.C. Station W2XWG.

RAYMOND F. GUY

Radio Facilities Engineer, N.B.C.

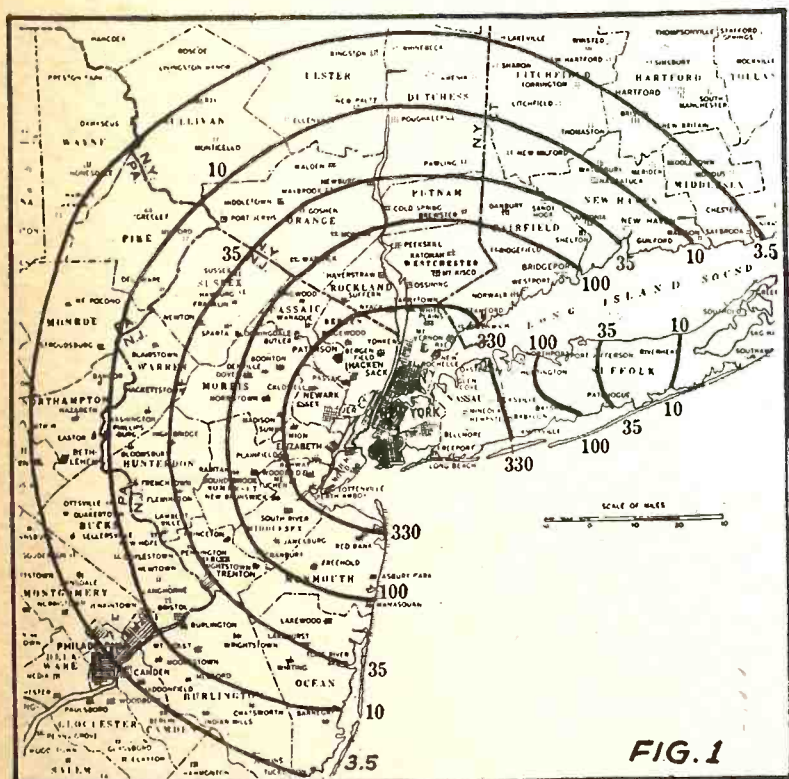

"W2XWG's field intensity pattern in microvolts/meter (irrespective of the type of modulation). These measurements represent a power of 1,000 W., a transmitting antenna height of 1,300 ft., a receiving antenna height of 30 ft. and an operating frequency of 42.6 megacycles."

FIG. 1

THERE is widespread belief that many present-day developments are fundamentally new within the last few years.

On the contrary, the bases of many so-called new developments date back a great number of years. It is true, however, that only recently has it been possible to utilize to fuller advantage the possibilities of many of the ideas passed down to us by early investigators of the Radio Art. New instrumentalities have made it possible to explore these fundamental ideas to much greater extent. Transmission and reception at ultra-short wavelengths, or ultra-high frequencies, is one such outstanding example.

U.-H.F.

The use of the ultra-high frequencies for sound broadcasting offers technical advantages, not only to the broadcaster but to the public, which is much more important. The technical advantages consist of (a) escaping the 10-kc. channel limitation, (b) getting away from static, and (c) eliminating all except spasmodic long-distance interference.

We've known this for years, have experimentally operated low-power U.-H.F. stations since Way Back, and have enjoyed the experience of receiving Clean Stuff from our little ultra-high frequency transmitters when QRN, with devastating wallops, washed out our temporarily musclebound 50 kw. steamrollers. Five years ago the F.C.C. had applications for, or had licensed,

over 100 ultra-high frequency transmitting plants and it seemed that a trend was developing toward ultra-high frequency broadcasting, but this trend was not sustained. Interest has been revived in recent months through the promotion of F.M. on the ultra-high frequencies.

WHAT DOES F.M. OFFER?

Frequency Modulation is a weapon against noise, a sword if you please, with advantages which can be calculated accurately and simply, as we shall see. But unreasonable powers should not be attributed to it. The pen should not be mightier than the sword.

Your scribe bows low and humbly attempts, with these hesitant strokes, to bring to you gentlemen of the A.T.E. Journal what the Lower Classes vulgarly call the Lowdown. A snack of inside dope.

Let's get to the point. What advantages does F.M. really give over A.M.? Using the frequency deviation approved for the industry by the F.C.C., F.M. UNDER THE OPTIMUM CONDITIONS gives (a) an advantage of 20 to 1 in background noise suppression, (b) an advantage of at least 30 to 1 in rejection of shared-channel interference, depending on the beat frequency, and (c) some advantage to the broadcaster in capital expenditures and operating costs. There you have it.

F.M. IN 1902!

One frequently meets laymen who have the mistaken idea that F.M. is a revolution-

ary new invention. The justly proud father of your profoundly humble scribe bought him his first lace velvet pants in 1902. Most of you were still unborn during that antediluvian era.

It was in that year that a gentleman named Ehret applied for a patent which was issued in 1905 covering the basic method of F.M. for voice and code transmission and reception!

Mr. Ehret proposed to shift the carrier frequency by means of a voice-actuated condenser. He proposed an off-tuned circuit in the receiver for converting the frequency-modulated waves into waves of varying amplitude.

With certain improvements these are the methods now used. For code signalling he proposed to key the transmitter inductance or capacity to change the carrier frequency. Before the No. 1 war this method was very widely used for many years on longwave transmitters. Remember how discombobulated one could become by trying to read the backwave when fatigued?

"WIDE SWING" F.M.

Frequency Modulation research has been carried on for over 30 years and, except for 1918, 1920 and 1924, patents have been issued on F.M. methods and devices each year for the last 25 years. They were granted mostly to a number of inventors in the employ of organizations which spend large sums on research, such as G.E., Westinghouse, A.T.&T. and RCA, and to a few individuals, particularly Major Edwin H. Armstrong who has promoted use of the feature of "wide swing" in F.M.

Other features are important in F.M. such as limiting. Gentlemen named Wright and Smith filed a patent application covering it 15 years ago. Fourteen years ago, and subsequently, patent applications were filed and granted to Westinghouse, A.T.&T. and RCA on balanced, or "back-to-back" F.M. demodulators. The most commonly used discriminator today was patented by S. Seeley of RCA. Frequency multiplication of an F.M. wave to increase the frequency shift is covered in patents issued to Westinghouse, and G.E., for which applications were filed in 1926 and subsequent years. High frequency pre-emphasis and de-emphasis circuits were patented by S. Seeley and others of RCA. Its introduction to the industry was due in considerable part to the efforts of N.B.C.

At the close of 1939 more than 250 patents had been granted on either Frequency or Phase Modulation, of which more than 160 covered F.M. About 10 years ago R.C.A.C. was trying F.M. on channels between our East and West coasts. About 12 years ago your scribe co-operated with Westinghouse in F.M. tests between New York and Pittsburgh. So you can see F.M. isn't new.

HI-FI A.M.

There is a popular impression that by use of F.M. and "wide swing" the public may only now enjoy high fidelity. The facts are that with ultra-high frequencies the fidelity can be made as good as anyone wants it to be with either frequency or amplitude modulation. Any improved fidelity is made possible by getting away from the 10-kc. channel allocations of the Standard Broadcasting Band and not by using F.M.

Furthermore, to get "high fidelity" in A.M. or F.M. receivers the listener must pay exactly the same high price for high-power, low-distortion audio amplifiers, loudspeakers and acoustical systems. However, the time may come when High Fidelity will receive the widespread recognition it merits. There is much more interest now in low receiver prices which preclude high fidelity. This is unfortunate but incontestably true regardless of any wishful or idealistic thinking to the contrary.

There is no lack of satisfactory fidelity in present-day transmitters because, if for no other reason, the F.C.C. requires it. The loss of fidelity rests in the home receivers. Medium-priced receivers satisfy the public demand and high fidelity cannot be obtained in those models. The price paid for so-called high-fidelity amplifiers and loudspeakers is in itself more than the cost of most receivers. Possibly 1 person in 6 has a receiver of good fidelity. Many of these listeners normally operate with the tone control adjusted for the lowest degree of fidelity possible with such receivers. It appears that the public is not suffering any lack of fidelity because of the present broadcasting system.

We in N.B.C., and others, have been providing transmission of excellent fidelity for at least 15 years (network lines excepted) and will continue to do so. We believe in it and endorse it. But we have no illusions about the public reaction toward it.*

NOISE THRESHOLD

Frequency Modulation would under favorable conditions, but not all conditions, reduce static about 20 to 1. But what static are we talking about? Static practically doesn't exist on ultra-high frequency. Therefore, isn't its absence mainly due to the shift to the ultra-high frequency band? It is.

Don't think that your humble servant is bearish on F.M. because that would be incorrect. It is cold professional realism, not bearishness. An F.M. station will provide noise-free service to a much greater distance than an A.M. station of equal power because F.M. can suppress receiver hiss noise, auto ignition noise and other ultra-high frequency disturbances about 20 to 1, if the carrier is stronger than the noise and if the receivers have enough gain to make the limiters limit at low field intensities. Some F.M. receivers begin to slack off at about 100 microvolts. To obtain the full benefit of F.M. out to the "noise threshold" limit they should hold up down to 10 microvolts. This noise threshold is strictly an F.M. phenomena; more on this later.

We are all confident that Television has a most brilliant future. We are not entirely clear on the position that Ultra-High Frequency Sound Broadcasting will have with respect to it. Those of us who have lived with television for many years feel that sound is supplemental to sight but definitely second in importance. When television hits its stride, sound broadcasting may assume the status of silent pictures. Who knows? Nobody does. In any event, sound broadcasting will be with us for many more years and we should give full

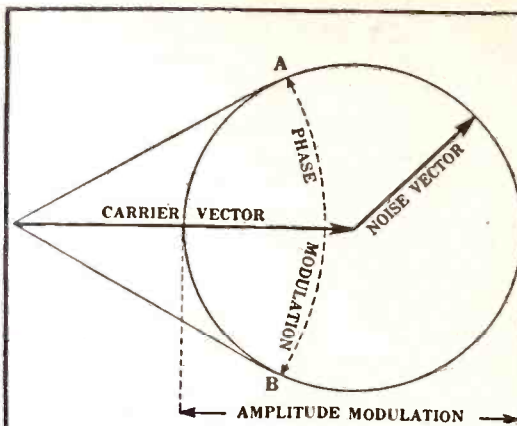

FIG. 2

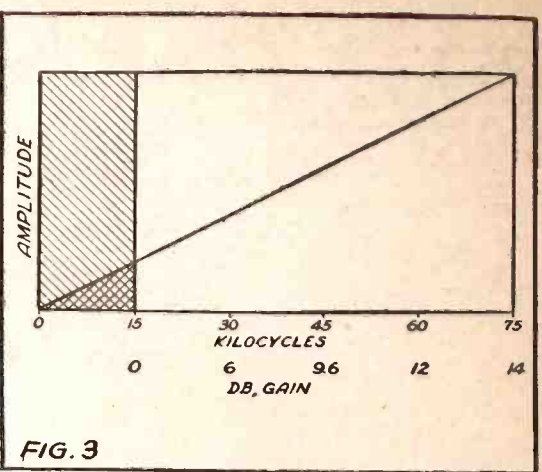

FIG. 3

opportunity to improved methods and devices. F.M. is one of them. N.B.C. has one F.M. station and will build more. F.M. is being given its chance to prove itself.

The N.B.C. has for many years viewed realistically the advantages of the ultra-high frequencies and has been confident that the industry would, in time, do likewise. Five years ago Mr. Hanson and your profoundly humble scribe wrote a long report on the subject forecasting the growth of ultra-high frequency Sound Broadcasting by 6-month intervals and hitting very close. Frequency Modulation had such promising theoretical advantages that we undertook a full-scale field test to determine the extent to which they could be realized in practice.

\$30,000 WORTH OF TESTS

As a result we completed, last year, at a cost of over \$30,000, the most thorough field test of F.M. ever undertaken and we have the information we sought.

It was obtained, not by laboratory work, which had been done before by others, including R.C.A.C., nor merely by operating an F.M. station, but by building special transmitters, receivers, measuring instruments, etc., and then painstakingly making thousands of measurements at distant points over many months and under a variety of conditions.

A special 1,000-watt transmitter was ordered from the R.C.A.M. Company. It had facilities for both A.M. and any degree of F.M. deviation or "swing" desired, with remote control facilities for instantaneously switching to either system. Since the F.M. deviation varies directly with the audio input level, remote controlled pads could be and were used to select the deviation desired.

W2XWG was installed in the Empire State Building. Special authority was obtained from the F.C.C. to use amplitude modulation as well as F.M. on 42.6 mc. for the term of the project. The television video antenna, having a pass band extending from 30 to 60 megacycles, was used for most of the W2XWG transmissions although a special folded dipole was used when the video antenna was transmitting "pictures."

W2XWG was equipped with means for continuous variation of power between 1/10-watt and 1,000 watts, and a vacuum-tube voltmeter for accurately measuring the power.

The modulation conditions selected were A.M./F.M. 15 (deviation of 15 kc., or total swing of 30 kc.), and F.M. 75 (deviation of 75 kc. or total swing of 150 kc.). Tone modulation was used for most measurements. For measuring distortion, or noise levels with modulation present, the tone output of the receivers was cleaned up by passing it through filters and then impressed upon RCA noise and distortion meters.

Four special receivers were built by the R.C.A.M. Company for this project. Each

was equipped for instantaneous selection of A.M./F.M. 15 or F.M. 75. Two complete I.F. systems were built-in, one 150 kc. wide and one 30 kc. wide, each having 5 stages, with both A.M. and F.M. detectors. All receivers contained meters, controls, de-emphasis circuits with keys, 8-kc. cutoff filters with keys, separate high-quality amplifiers and speakers, cathode-ray oscillographs, etc. Each receiver had sufficient R.F. gain to give full output with limiting at input levels much lower than required, theoretically doing so with only 1/10-microvolt input. These receivers were made as good as receivers can be built in order that our conclusions on F.M. would not be clouded by apparatus shortcomings. Sacrificing good receiver design to price will not permit the full gain of F.M., as reported herein, to be realized.

FIELD INTENSITY

As a part of the project, a field intensity survey was made of the W2XWG transmissions. The map is included herein for 1,000 watts, 1,300 feet antenna height and .7 antenna gain. It is Fig. 1.

Measurements and electrical transcriptions were made under a variety of conditions at the following locations:

	Miles
Collingswood, N. J.	85
Hollis, L. I.	12
Floral Park, L. I.	15
Port Jefferson, L. I.	50
Commack, L. I.	36
Riverhead, L. I.	70
Hampton Bays, L. I.	78
Bridgehampton, L. I.	89
Eastport, L. I.	65
N.B.C. Laboratory	1
Bellmore, L. I.	23

All above stations are temporary, with the exception of the last two, which are permanent.

Most of the measurements were made at the Bellmore station. For the temporary stations, 2 automobiles were equipped and used, one a Radio Facilities Group measuring car, the other a borrowed R.C.A.C. truck full of recording gear. The receiving stations represented a cross-section of rural and suburban Americana.

Let's next see what theoretical advantage F.M. has in noise suppression and how it is obtained. Later we will see what we measured.

In F.M. the deviation of the carrier frequency can be made as great as desired. If it is 15 kc. and the audio band-width is 15 kc. the deviation ratio is 1, corresponding to the deviation divided by the audio band-width. If the deviation is 30 kc. the deviation ratio is 2, etc.

The advantages of F.M. over A.M. in noise suppression are contributed by 3 factors:

- (1) The triangular noise spectrum of F.M.
- (2) Wide swings, or large deviation ratios.

(* See the first item under "SOUND" in the June, '41, issue of Radio-Craft, pg. 715.—Editor

(3) The greater effect of de-emphasis in F.M. compared to A.M.

Let us consider them in order.

TRIANGULAR NOISE-SPECTRUM

An F.M. system with a deviation ratio of 1 has an advantage in signal-to-noise ratio of 1.73 or 4.75 db. for hiss or other types of fluctuating noise.

Since the figure 1.73 applies to such noises as *tube hiss*, which is comparatively steady in amplitude, we will consider this type of noise. It differs from *impulse noise* such as is produced by automobile ignition systems.

Tube hiss consists of a great many closely overlapping impulses or peaks. There are so many of them at all audio frequencies, we are concerned with, that the noise has a steady characteristic. When combined with a steady carrier of fixed frequency, the noise peaks beat with the carrier. The noise peaks also beat with each other. When the carrier is considerably stronger than the noise peaks, beats between the noise peaks become negligible in amplitude and the predominating noise is due to the combination of carrier and noise peaks.

Since a combination of 2 carriers differing in frequency produces a similar phenomenon, we will treat both cases at the same time. The effect is most easily shown and understood by means of a simple vector diagram.

The strongest carrier vector continuously rotates through 360° and is indicated on Fig. 2. The weaker carrier, or the "noise voltage," rotates around the carrier vector at a frequency which is equal to the difference between the desired carrier and undesired frequency.

It will be seen that amplitude modulation is produced. If the undesired frequency is 50% as strong as the desired frequency, 50% amplitude modulation results. As the undesired vector rotates around the desired vector, *phase modulation* also is produced between the limits A and B. The faster the undesired vector rotates, or the faster the rate of phase change becomes, the greater becomes the momentary change in frequency and, therefore, the greater the frequency

modulation becomes, because Frequency Modulation is a function of the first differential of phase modulation. Therefore, the amplitude of the frequency modulation noise or beat note varies directly with beat frequency. With both frequencies exactly the same there is no amplitude modulation nor is there any frequency modulation.

Such being the case, the noise frequencies close to the carrier produce little frequency modulation noise but as the noise components further from the carrier combine with it they produce more frequency modulation. Therefore, the higher the noise beat frequency the higher its amplitude. This results in a frequency modulation noise spectrum in which the noise amplitude rises directly with its frequency. In other words, it is a *triangular spectrum*.

In amplitude modulation there is no such effect as this. All noise components combine with the carrier equally. Therefore in amplitude modulation there is a *rectangular noise spectrum*. The ratio of noise voltages in F.M. and A.M. is therefore the ratio between the square root of the squared ordinates of a triangle and a rectangle. This ratio is 1.73 or 4.75 db.

DEVIATION RATIO

For an F.M. System the suppression of *fluctuation noise* is directly proportional to the deviation ratio.

On Fig. 3 the A.M. noise spectrum corresponds to the total hatched area below 15 kc. because the I.F. system would cut off there. The F.M. 75 receiver I.F. system actually accepts noise out to 75 kc. and it has the usual F.M. triangular characteristic. However, the receiver output and the ear responds only to noise frequencies within the range of audibility, around 15 kc., and rejects everything else. Therefore, the F.M. 75 noise we actually hear corresponds only to the small cross-hatched triangle and all the rest is rejected.

The maximum height of this F.M. triangle, corresponding to voltage, is only 1/5th of the height of the A.M. rectangle. Such being the case the F.M. 75 advantage is 5 to 1, or 14 db.. Simple?

(To be Concluded Next Month)

VERSATILE AMPLIFIER USING OLD DEJUR-AMSCO RESISTANCE-COUPLED AMPLIFIER UNIT

I am enclosing a diagram (reproduced here—*Editor*) of a handy little amplifier which I use for many different experiments.

It is swell as a hearing-aid amplifier or as a photoelectric-cell amplifier. It can also be used as the audio channel of a broadcast receiver or of a shortwave receiver by merely attaching to the input terminals a single tuned-radio-frequency stage. Essentially, the amplifier was made from one of those old DeJur-Amsco resistance-coupled amplifiers which were so popular many years ago, with very little changes.

I picked up the amplifier unit for a song, by mail, from a New York house. Most of the components are already mounted on the molded bakelite base including the 4-prong sockets, and the 6 fixed resistors. All of the components were already wired in place when I got the unit so that in a very short time I had my amplifier working. Although the original unit was designed for much older type tubes such as the 01As, etc., I use 3 type 30 tubes with very excellent results. What I like best about the unit is that all components as well as all battery and input and output terminals are mounted on top of the unit,

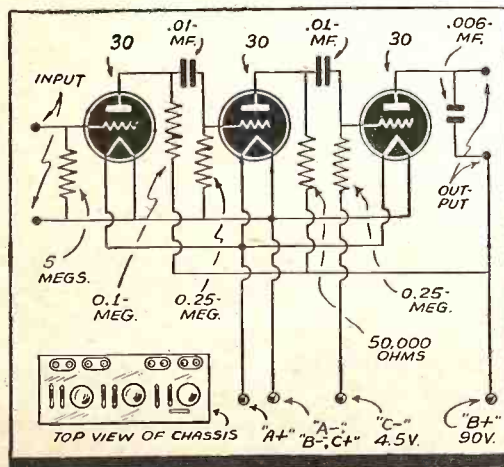

which makes it very easy to experiment with.

Although no provision is made for volume control, this can be added in place of the grid resistor of the second 30 tube. I find it simpler to control the volume at the input in order to avoid making changes in the amplifier itself.

L. FELDMAN,
New York, N. Y.

It's Meissner again

WITH A BRAND NEW

F-M ★ A-M

3-BAND COMBINATION

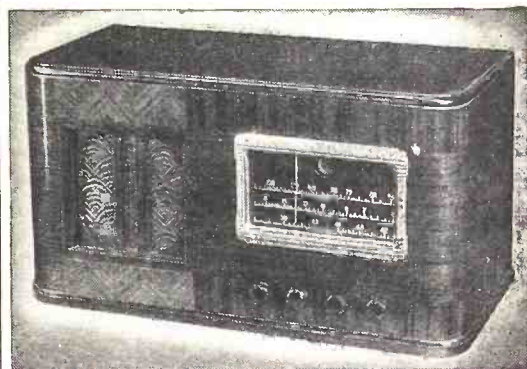

TABLE MODEL RECEIVER that has everything!

- ★ Two-tone, hand-rubbed walnut cabinet
- ★ 12¼" high — 22¾" wide — 11" deep
- ★ FM and AM in two separate channels
- ★ Covers Broadcast and Short Waves on AM
- ★ Full coverage of 42-50 mc FM band
- ★ Calibrated glass scale, edge-lighted
- ★ Tuning indicator, accurate adjustment
- ★ Includes seventeen latest type tubes
- ★ High-gain RF stage on all three bands
- ★ Wide-band I-F channel on both AM bands
- ★ 3-stage I-F channel on FM at 4.3 mc
- ★ Audio system common to both channels
- ★ Response flat from 30 to 15,000 cycles
- ★ Push-pull output, 6½ watts undistorted
- ★ Heavy-duty 8" PM Hi-Fidelity Speaker
- ★ Operates on 105-125 volts, 50-60 cycles

Complete Receiver as shown, with tubes,
Model 9-1053 List Price \$108.00

Chassis Only, with tubes
Model 9-1054 List Price **\$95.00**

See Your Jobber Today!

1941 INSTRUCTION MANUAL



Now Ready!

Contains complete instructions for all Meissner Kits
Circuit Diagrams
Parts Lists
Pictorial Diagrams
Charts and other useful data
ONLY 50c NET!

WRITE TODAY FOR FREE 48-PAGE COMPLETE CATALOG

Address Dept. C-7



SOUND ENGINEERING

*Free Design and Advisory Service
For Radio-Craft Subscribers*

Conducted by A. C. SHANEY

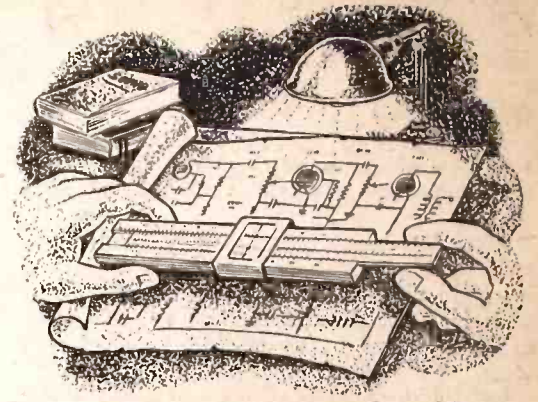

This department is being conducted for the benefit of RADIO-CRAFT subscribers. All design, engineering, or theoretical questions relative to P.A. installations, sound equipment, audio amplifier design, etc., will be answered in this section. (Note: when questions refer to circuit diagrams published in past issues of technical literature, the original, or a copy of the circuit should be supplied in order to facilitate reply.)

No. 19

EARPHONE CONNECTIONS

The Question . . .

I am a former radio Serviceman and am now a patient in this hospital. I keep up with radio now through *Radio-Craft*.

I have decided to try to get the doctors here to make a rule requiring the use of headphones with all private radio sets. To help me in this, I bought a model PT-25 Philco, a pair of 20-ohm Trimm phones and a pair of 3,000-ohm Brandes phones to enable me to show the doctors, etc., how loud a small set is, even when it is turned down low, and how enjoyable headphone reception is.

But I have not been able to get enjoyable headphone service with either of my phones. In both cases, reception is tinny and the high notes don't come in full and rounded. They are blasted. Two other fellows here had this same trouble with 2 pairs of 11-ohm phones. So this must be a common trouble.

I have read in several places that nothing is simpler than connecting a pair of phones to an electric set with satisfactory results. But I notice that amateur sets use crystal phones "as they do not change the electrical characteristics of the circuit due to their high resistance."

In addition to getting good results with phones myself, I want to find out all I can on the subject of connecting phones to electric sets. Will you please write me the fundamental truths of connecting phones to electric sets so that good results may be obtained?

I am especially interested in: Why reception with phones was tinny and unsatisfactory in the above cases, and the simplest ways to remedy this trouble with both low and 3,000-ohm phones; whether you can easily get good results with magnetic phones; whether crystal phones give much better results with battery and electric sets and why they don't change the characteristics of a circuit and so give good tone quality when they are used; what are the other fundamental truths that must be respected to get good phone reception with electric receivers?

I want to know enough about this subject to be able to tell anyone how to get good phone reception. The Servicemen here, judging by the carelessness with which they have connected phones in the above cases, don't seem to care whether they provide good phone reception or not. They very likely don't know how to. I will be glad to pay a dollar or two for a full exposition on how to get good results with phones, especially magnetic phones and electric sets. I could never get a rule made here requiring the use of phones with private "radios" if crystal phones had to be used.

JEROME FOWLER,
Bryce Hospital,
Tuscaloosa, Alabama

The Answer . . .

This department, as you undoubtedly know, supplies information to *Radio-Craft* subscribers entirely free of charge, so that it will not be necessary for you to pay \$1

or \$2 for a concise exposition covering requirements for good phone reception.

There are 3 basic elements involved in obtaining satisfactory headphone reception. These are: (1) Response characteristics of the headphones. (2) Detrimental changes in the output circuit of the receiver. (3) Inter-coupling circuit employed between receiver and headphones.

Before you can obtain high-quality reproduction in headphones, it is obviously necessary to use phones that have reasonably good response characteristics. Most headphones are peaked in the central portion of the audio spectrum. That is, they do not reproduce both the very low and the very high frequencies satisfactorily. Your first step, therefore, would be to select a good pair of phones.

The only way to do this is to test them for flat response. The suggested circuit of Fig. 1 indicates a laboratory set-up. An oscillator is fed to an amplifier and through a suitable coupling network to the phones under test. A V.U. meter is connected across the phones and 1,000-cycle single frequency is impressed upon the phones, until the signal becomes uncomfortably loud or just before the phones rattle, whichever condition occurs first (while making this test, the phones should be worn on the head in a normal manner). The V.U. meter reading is notated, and the oscillator frequency gradually changed through the entire spectrum. The amplifier gain, however, is adjusted so that a constant voltage is applied across the phones while the frequency is being changed.

A good pair of phones will produce the same sensation of loudness on all frequencies tested (it is assumed that the listener has normal hearing, and that the tests are made at a very high level, near the threshold of feeling). Any pair of

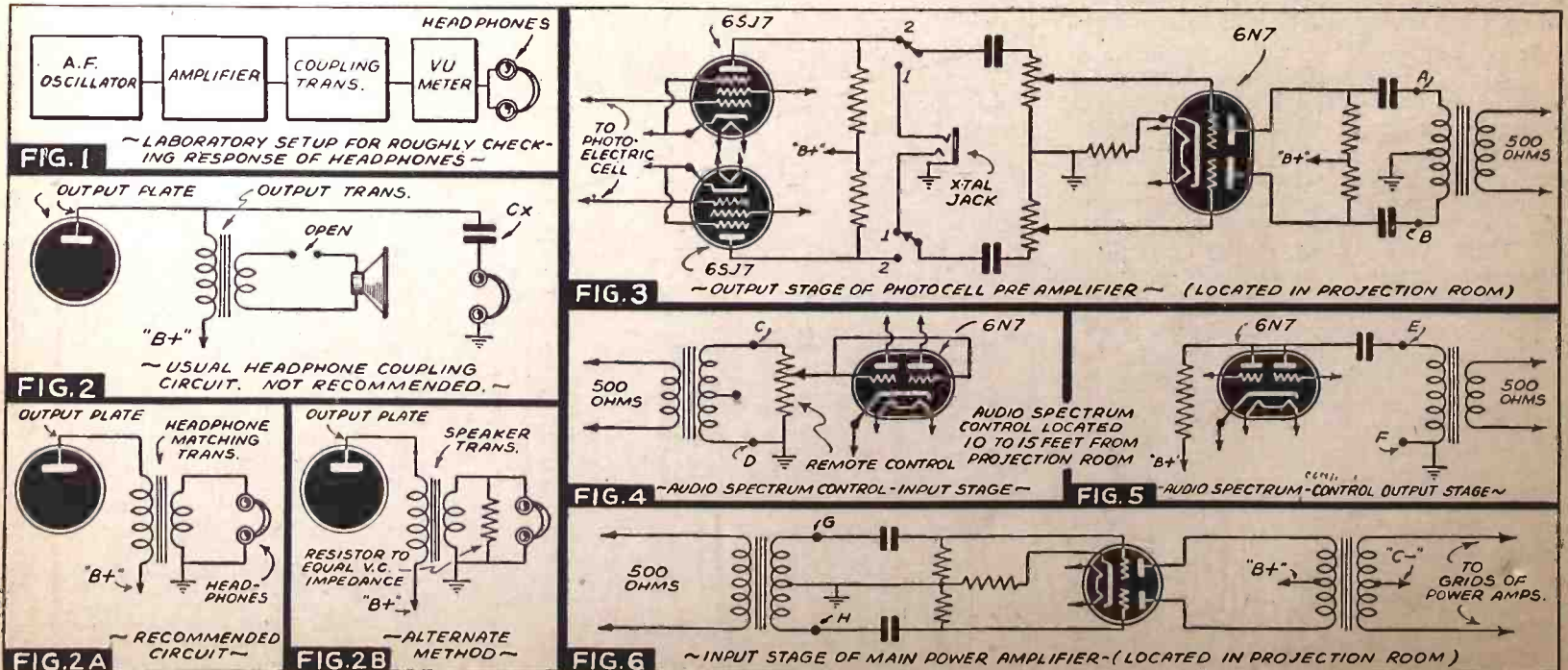

FREE TO RADIO-CRAFT READERS!

"Send Us Your Name—Get This Valuable Encyclopedia Volume

FREE!"

**No Strings!
No Catches!
NOTHING TO BUY!**

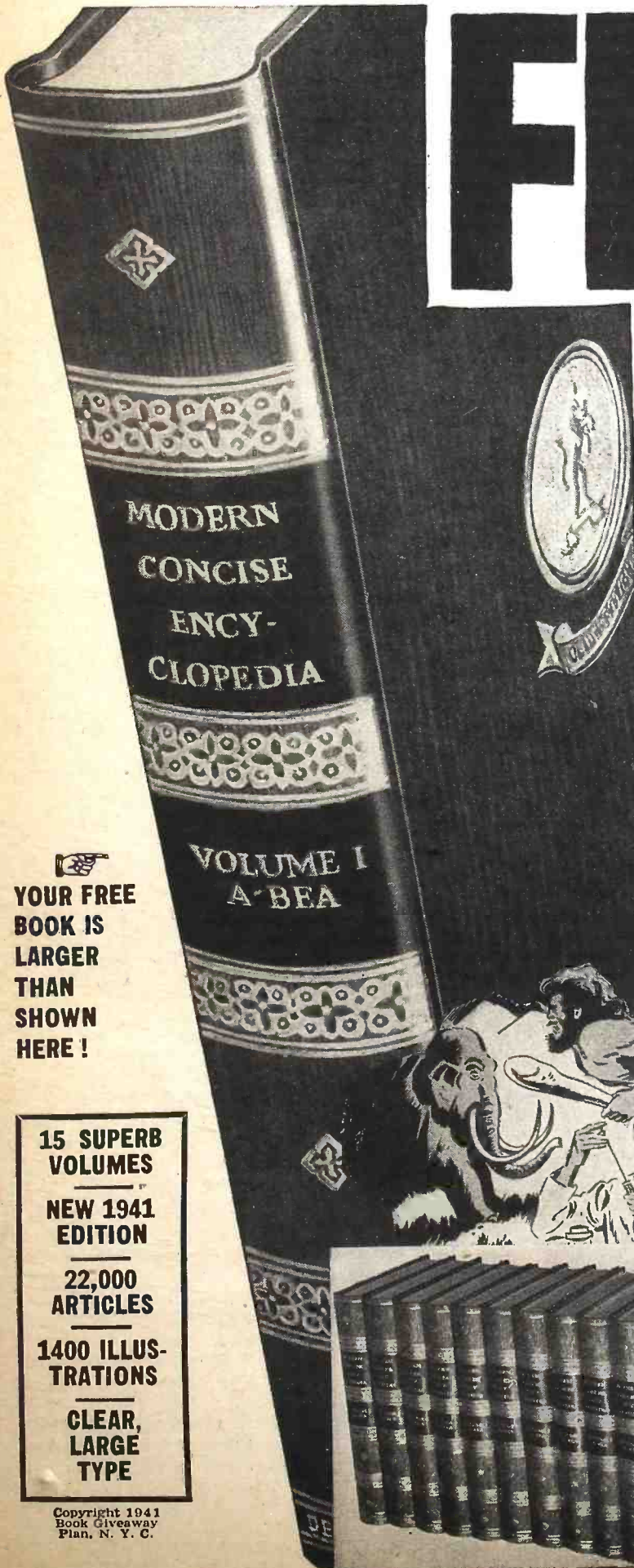

Yes, this volume is our outright gift! There is no obligation to do anything or buy anything. Simply mail the gift coupon below, and we send you Volume One of the Modern Concise Encyclopedia! We give it to you free—for the mailing charge—and after you examine it—you are given the privilege of accepting the rest of the big fifteen volume set almost as a gift.

FINEST CONCISE ENCYCLOPEDIA IN AMERICA!

Imagine! Through this sensational offer you can own the brand new edition of the finest set of concise encyclopedias in America! Books bigger than full library size, much larger than pictured, handsomely bound in deep green cloth, stamped in red, and gilded—expensively made volumes you will be proud to own—yours at next to no expense!

want to know, clearly written and illustrated. They are written for YOU—for the information you seek on History, Biography, Geography, Medicine, Industry, Music, Religion, and 22,000 MORE subjects—a rich mine of information providing more FACTS than a college education.

14 MORE BOOKS—ALMOST A GIFT!

You are also entitled to an EXTRA PRIVILEGE. We reserve in your name all the rest of the fourteen volumes. And—unless you cancel your reservation—you receive one every week, as they come off the presses. But you will not be charged for these volumes the high price they are worth—merely a PRIVILEGE PRICE—a price so small that every reader will know he is receiving the volumes PRACTICALLY AS A GIFT! Remember—these are genuine encyclopedias—books that contain EVERYTHING you ever

CHOICE OF DELUXE EDITION

One further privilege. If you prefer, you can have your set in the superb DeLuxe Edition pictured at left—bound in red artificial leather, stain and waterproof, embossed and gilded—distinguished volumes built for lifetime use, with extra heavy covers, woven head and tailbands, and many other DeLuxe features. There is NO EXTRA CHARGE FOR VOLUME ONE in DeLuxe Edition. You can have Volume One FREE in your choice of editions. However, the remaining 14 volumes in DeLuxe Edition because of the great expense of DeLuxe features, will cost you slightly more than Regular. Read the coupon very carefully before checking the edition you desire.

HOW TO GET YOUR FREE BOOK!

First read the Gift Coupon below. Then check whether you want Regular or DeLuxe. Mail coupon to us enclosing 10c coin and 3c stamp. We send you by return mail your free Volume One in the edition you desire. This book BELONGS TO YOU whether you want the rest of the set or not. We also reserve the rest of the 14 volumes in your name, and we give you the EXTRA

PRIVILEGE of receiving these volumes as they come off the presses—one book each week. And if you decide not to cancel reservation, you get these books by paying the postman the SPECIAL GIFT PRICE—only 49c per volume for Regular Edition or 79c for DeLuxe Edition, plus a few cents mailing charge—and NO MORE! Send in for your first free volume TODAY!

YOUR FREE BOOK IS LARGER THAN SHOWN HERE!

15 SUPERB VOLUMES

NEW 1941 EDITION

22,000 ARTICLES

1400 ILLUSTRATIONS

CLEAR, LARGE TYPE

Copyright 1941 Book Giveaway Plan, N. Y. C.

ACT NOW!

READERS GIFT COUPON

BOOK GIVE-AWAY PLAN

P. O. Box No. 56, Brooklyn, N. Y.

Enclose 10c in Coin and 3c Stamp to Cover Mailing Charge

Please send me free Volume One of the Modern Concise Encyclopedia in the edition checked below. I enclose 10c coin and 3c stamp to cover mailing charge on my free book. Please also reserve the balance of a set in my name. After I examine my free Volume One I can cancel this reservation; otherwise you may send me the rest of the set at the rate of a volume a week, and I will pay the postman C.O.D. the SPECIAL GIFT PRICE of only 49c per volume for Regular Edition, or 79c per volume for DeLuxe Edition (plus a few cents mailing charge). Volume One is mine to keep in any case.

Name

Address

City & State

Which Edition Regular DeLuxe } The 10c mailing charge is the SAME for either edition. **RC**

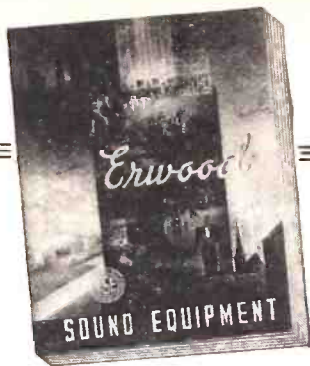

Send for your

FREE COPY NOW!

New catalog of the most complete and modern line of sound equipment is yours for the asking. It lists and illustrates

- Portable and Fixed Systems
- Centralized Radio Systems
- Paging and Factory Call Systems
- Parts and Accessories

Get your free copy—WRITE—now.

ERWOOD
SOUND EQUIPMENT CO.
221 W. Erie St. Chicago, Ill.

SENSATIONAL SOUND OFFER

To acquaint Sound Men Everywhere with the unbeatable qualities of LIFETIME P.M. Speaker Units and Trumpets we make this STARTLING OFFER - One 4' Trumpet - List \$40.00 One No. 40 P.M. Unit List \$40.00 One Trumpet Mounting List \$15.00 - A total List of \$95.00 - the complete Unit for only \$30.00

CASH WITH ORDER



Send for this IMMEDIATELY and get information on our complete line of Trumpets, Baffles, Speakers and Microphones - at AMERICA'S LOWEST PRICES!

THE LIFETIME CORPORATION
1621 ADAMS ST., TOLEDO, OHIO



WOODSTOCK TYPEWRITERS

PATENTS—TRADE MARKS

Booklet concerning Inventions & Patents Form "Evidence of Conception" with instructions for use and "Schedule of Government and Attorneys Fees"—Free
LANCASTER, ALLWINE & ROMMEL
Registered Patent Attorneys
436 Bowen Bldg. Washington, D. C.

phones that seem to fall off at either the high frequencies, above 5,000 cycles, or at the low frequencies, below 100 cycles, will not provide satisfactory results when used with a radio receiver.

While there are more elaborate tests to check response of phones, this comparatively simple way should be more than adequate for your immediate needs. You may, of course, if you buy the phones from a reputable manufacturer, accept his claims regarding the frequency characteristics of the instrument.

After the proper headphones are selected, the next step is to connect the phones to the receiver without introducing any detrimental circuit changes. As most modern midget receivers employ either a pentode or tetrode output, it is imperative that the correct load impedance be maintained in the output circuit. I presume that you will disconnect the loudspeaker from the receiver. If this is done, the loudspeaker transformer should be removed from the circuit and a suitable coupling transformer substituted instead, so as to match the headphones to the output tube.

The usual methods of connecting headphones to outputs of receivers are basically incorrect, because consideration is not given to proper termination of the output circuit, or to a non-frequency-discriminating coupling circuit. High-impedance headphones are invariably coupled to the output stage through a paper condenser, as illustrated in Fig. 2. The condenser CX being reactive in nature, changes its impedance with frequency, so that at 50 cycles, it will have an impedance of approximately 20 times that of its 1,000-cycle value. This will usually introduce a considerable low-frequency loss and contribute greatly to loss of quality. While this circuit arrangement may be satisfactory for amateur use, because they are interested in voice transmission only, for which low frequencies are of no importance, it is inadequate for high-fidelity musical reproduction.

The use of a high- or low-impedance phone, makes no difference insofar as quality is concerned, provided a correct matching transformer is used. A good pair of magnetic headphones, properly connected to the output of any receiver, should provide excellent results.

If it is inconvenient to change the output transformer in the receiver, the speaker voice coil may be disconnected from the secondary of the output transformer and a suitable terminating resistor used instead. High-impedance phones of the magnetic or crystal type can then be connected directly across this resistor. If the impedance of the phones are at least 10 times that of the terminating resistor, no serious upset will take place in the output coupling circuit. The disadvantage of this arrangement, however, is that 9/10ths of the useful power will be dissipated in the terminating resistor. If the secondary of the output transformer is left unterminated, then the impedance reflected back into the plate circuit of the output tube may rise to a very high value and introduce a considerable amount of distortion, particularly in tetrode or pentode output tubes.

As you have not told me how you attempted to connect your headphone to the receiver, I cannot give you specific corrective measures, but I am sure that if you will follow the general procedure indicated, you should have no difficulty in satisfactorily solving your problem and convincing the doctors of the advisability of using headphones with private radio receivers. (The therapeutic value of radio reception, in many cases, is well established.—Editor)

MOVIE SOUND SYSTEM WITH REMOTE AUDIO SPECTRUM CONTROL

The Question . . .

In the redesign of our movie-sound system, we have encountered several problems which we hope you will answer for us. The general layout is as follows:

Located in the projection booth are the photocell preamplifier and the main power amplifier. These 2 amplifiers are each separate units and consist of two 6SJ7s, one 6N7, and one 6N7 into four 2A3s in push-pull parallel, respectively.

Located downstairs in the theatre proper is our remote tone and volume control assembly. This unit is known as an Audio Spectrum Control, and is similar to the device described in the June, 1938, issue of *Radio-Craft*, Page 797.

The loudspeakers are located directly back of the screen and are connected to the main power amplifier by means of a 500-ohm line. These speakers, one for bass, one for highs, are rated at 30 watts peak—25 watts continuous.

Diagrams (Figs. 3, 4, 5 and 6) show respectively the output stage of the preamplifier, the input stage of the remote audio control, the output stage of the remote audio control, and the input stage of the main power amplifier.

Now then, we have 3 general questions to ask of you. The first general question is: How best to couple the remote audio control unit to the input and output stages of the preamplifier and main amplifier? The remote control unit is located approximately 15 feet from the projection booth wherein are located the amplifiers. The only method suggesting itself to our minds is the use of 500-ohm matching transformers, as shown (Figs. 3, 4, 5 and 6). Would this be a feasible plan? Would the frequency response be adversely affected? Could one side of all the 500-ohm lines (including 500-ohm speaker line) be grounded, and would there be any chance of hum pick-up from using these transformers?

The next question: Could the leads from our Astatic model B-16 crystal phono pickup be 15 feet without affecting the frequency response? Also, is it possible to connect this type pickup into a push-pull input stage?

The last question: The size of our auditorium is approximately 22 x 18 x 60 ft. From the previous descriptions of the speaker assembly and sound equipment, do you think we have sufficient audio power and a suitable setup for this size hall?

Thanking you in advance for any assistance and information you may render and trusting that we may hear from you at an early date.

G. F. LAST,
Lake Tomahawk, Wis.

The Answer . . .

It would be highly desirable to eliminate the use of coupling transformers, because of the comparatively close distance of the various components. With your suggested system, you will require a line transformer at the output of the preamplifier, a 2nd one at the input of the audio spectrum control, a 3rd one at the output of the audio spectrum control, and a 4th one at the input of your main amplifier.

The use of 4 transformers will exaggerate, by 4 times, any frequency discrimination characteristic. In other words, if one of these transformers is normally down 2 db. at 50 cycles, you can expect any circuit which uses 4 of them, to be down 8 db. Similar discrepancies will take place in the higher frequencies. I therefore believe the

most desirable procedure to follow would be to use high-impedance interconnecting circuits and employ coaxial cables. The comparatively short lengths involved will probably introduce a loss of 2 or 3 db. at 10,000 cycles. The low-frequency end will remain unaffected.

The use of transformers is further undesirable, in view of possible hum pick-up. It will be necessary to use comparatively expensive hum-shielded units, and I believe that when everything is taken into consideration, their use is definitely contra-indicated.

In running inter-connecting push-pull leads, you should use dual-conductor coaxial cable. The outer shield can be used as a common ground.

Any crystal pickup can use indefinitely long leads, without affecting frequency response. The only disadvantage of such an arrangement is attenuation of all frequencies. In other words, the signal level will be dropped. The exact loss will depend upon the capacity of the cable. This subject was covered by Mr. H. S. Manney in "Modern Microphone Technique—Part II", which appeared in the March, 1941 issue of *Radio-Craft*, pg. 552, in discussing crystal microphone lines.

If you are obtaining approximately 20 watts from your four 2A3s in push-pull parallel, you have more than adequate power for your size hall, provided, of course, the surrounding noise level is comparable to an average theatre. It is assumed that your loudspeakers are reasonably efficient.

BOOK REVIEWS

ANTENNA MANUAL (1941), by Arthur H. Lynch. Published by Premax Products Division, Chisholm-Ryder Co., New York. Soft paper covers, size 8½ x 11 ins., 32 pages, profusely illustrated. Price 25c.

Under this title, Arthur H. Lynch has compiled a number of outstanding articles on the subject of Antennas. The contents ranges from discussions of the elements of good antenna design to complete working details for building all types of radio antennas, including types for Frequency Modulation reception. All the information is of paramount interest to the shortwave ham and fan. However, *anyone* with a yen to get better response with *any* type of radio set will find the information in this book most illuminating. And if he is of an inquisitive nature, he may wish to look up one or more of the dozens of references to technical articles, on the subject of antennas, on a page devoted to such references.

"Antenna Manual" will be helpful to radio students who want to learn the ABCs of how radio signals are brought into the receiving set.

FROM CRYSTAL TO TELEVISION: "The Electron Bridge"—A Simple Account of Wireless and Television, by Vyvyan Richards. Foreword by J. L. Baird (Latest Printing). Published by A. & C. Black, Ltd., London, England. American Agent, The Macmillan Co. Cloth covers, size 5½ x 7¼ ins., 116 pages. Price \$1.50.

Unlike a large number of books which attempt to present radio and television for the layman. "Crystal to Television" sticks close to technical accuracy while at the same time retaining readability for the non-technician.

Exceptionally interesting is the 2-page illustration showing the bases of radio transmission and reception. The 2-color plate includes a reproduction of the manner in which oscillation and generation are obtained in an elementary transmitter and receiver.

On the first page, author Richards introduces Maxwell (theory of radio), Hertz (demonstration of radio), and later technicians (development of radio); the importance of the vacuum tube ("The Electron Bridge") is immediately brought out in a short dissertation on Dewar (high vacuum).

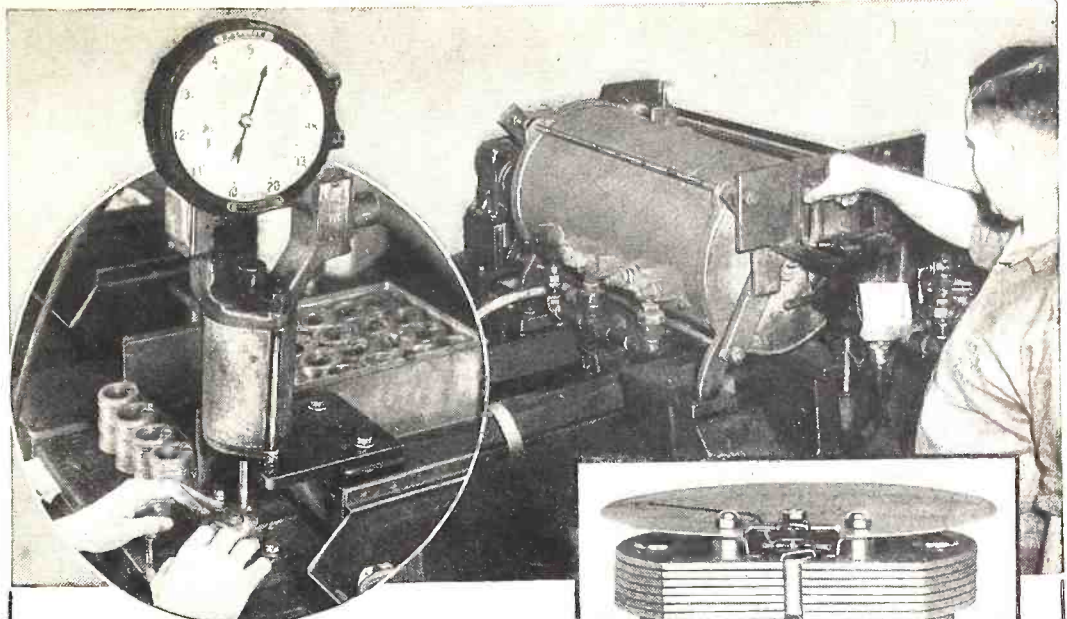

It's got to be right
TO BE **TRIPLET**

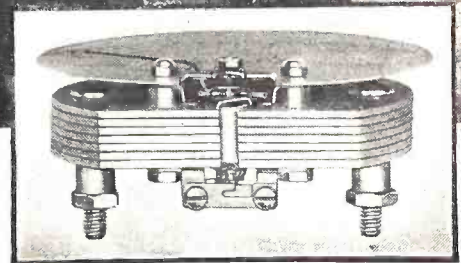

Interior View of D.C. Movement . . . Double truss bridge protects against any vibration—insures permanent perfect alignment of bearing supports, and provides correct scale readings.

In every phase of manufacture, Triplet exercises rigid control over the quality of every part. In instrument manufacture, for example, heat-treating magnets the Triplet way, plus careful ageing, insures permanency. Following heat-treating, processing by special electric hammers insures initial uniformity and freedom against change. Triplet instruments have perfect alignment magnetically and mechanically, with the result that scale readings are linear and free from "curve error." That is why Triplet instruments have been recognized internationally for their precision, long life, and reasonable prices. That is why more and more people are standardizing on Triplet instruments, because they know—"It's got to be RIGHT to be Triplet."

See Triplet's 1941-42 Line of Test Equipment—Booths 720-722 Chicago Radio Parts Show
Write for Catalog—Section 167 Harmon Avenue

THE TRIPLET ELECTRICAL INSTRUMENT COMPANY
Bluffton, Ohio

Chapter headings: I, The Nature of Electricity; II, Waves; III, Crystal and Valve; IV, Microphone to Moving-Coil; V, Television; Epilogue; Frame of Reference (defining the data, where needed, and indicating the problems of Sound, Light, and Electricity; with the names of the simplest books to consult).

THE MARVELS AND MYSTERIES OF SCIENCE, by Fisher, Gerould, Poole, Timm, Quirke, and Wissler (1941). Published by Wm. H. Wise & Co., Inc., New York. Cloth covers, size 6¼ x 9¼ ins., 805 pages, 800 illustrations. Price \$2.95.

This book has special appeal for anyone with a bump of inquisitiveness concerning the countless questions which daily confront all of us in this modern technological world.

Six professors, specialists in physics, astronomy, biology, chemistry, and geology, popularly explain the natural and man-made phenomena of the Earth and the Universe.

The portion of this book devoted to topics of direct interest to the radio men is small. However, most radio men are technically minded, and therefore, this work by 6 outstanding scientific authorities has fundamental appeal for almost everyone in the radio field.

Unlike most books of this general nature, it nourishes the reader with food that does not produce mental indigestion. It is divided into 5 sections as follows:

Section I—The Wonders of the Heavens; Section II—Our Home, The Earth; Section III—The Nature of Matter and Energy; Section IV—The Marvel of Living Things; Section V—Man and His Works.

Section III, by John A. Timm, Ph.D., Asst. Professor of Chemistry, Yale University, will have the greatest amount of interest for radio men, as its chapter contents indicates:

Chapter 11—The Importance of Molecules and Atoms; Chapter 12—Heat; Chapter 13—Sound; Chapter 14—Light; Chapter 15—Magnetism and Electricity; Chapter 16—Organic Chemistry.

In the opinion of this reviewer, "The Marvels and Mysteries of Science" should be recommended reading for all students by the time they reach high-school age.

NEW AUDIOGRAPH Sound Catalog

AUDIOGRAPH Sound Systems represent the latest in Sound Engineering and Design—a complete line plus pre-tested accessories.

NEW LOWER PRICES
Outstanding quality and performance at prices that help you meet any competition.

WRITE FOR FREE COPY

JOHN MECK INDUSTRIES
1313 W. Randolph St., Chicago, Ill.

RADIO EVERYTHING IN RADIO

This one big book serves your entire radio needs. It includes sets, parts and supplies, public address systems, amateur equipment, testers, kits and fluorescent lighting. You'll find the nationally known favorites at the lowest possible prices. Get your copy of this big FREE CATALOG today.

BIG FREE CATALOG HAS IT!

BURSTEIN-APPLEBEE COMPANY

1012-14 MCGEE STREET, KANSAS CITY, MISSOURI

NEW HAND SET

... for p. a. systems, mobile or remote programs, call systems, pack trans., etc. Dependable, long life, low price. Black Bakelite case with 6 ft. cord. Microphone and receiver terminated separately. Switch not available. Wt. complete only 7 oz., packed 1 lb. 75 ohms match line impedances: 2,000 ohms match plate circuit of output tube. Either resistance. \$10.00 List

Universal Microphone Co., Ltd.
Inglewood, Calif., U.S.A.

SIZZLING Lafayette VA

EASY-TO-SELL FLUORESCENT LIGHTING — A NATURAL FOR THE SLACK RADIO SEASON

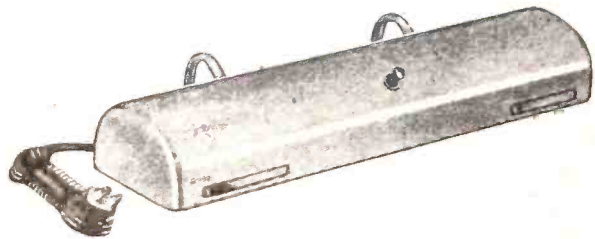

FLUORESCENT BED & UTILITY LAMP

A soft restful light, ideal for use as bedlamp but also as general utility light that can be clamped anywhere. Employs standard 18" 15 watt T8 fluorescent lamp bulb — white or daylight. Fixture finished in lustrous ivory and has high efficiency white enameled reflector. Operates on 110 volt 60 cycles AC. Shipping weight 4 lbs.
K25582—Less bulb. Lots of 3, each \$2.37.
YOUR COST SPECIAL, SINGLY.....\$256

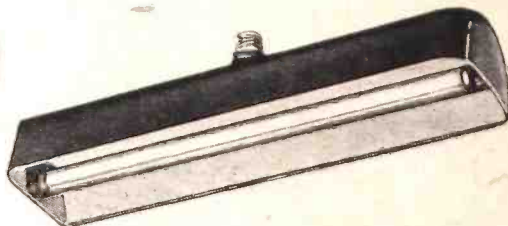

FLUORESCENT SWIVEL ADAPTOR

Exceptionally attractive. May be used anywhere — screws into lamp socket on regular fixture just like ordinary bulb. One piece steel with rich metallic brown finish. Employs single standard 18" 15 watt fluorescent lamp bulb. Operates on 110 volt 60 cycles AC. Ideal for use over sinks, benches, ping pong tables, etc. Shipping weight 4 lbs.
K25583—Less bulb. Lots of 3, each \$2.37.
YOUR COST SPECIAL, SINGLY.....\$256

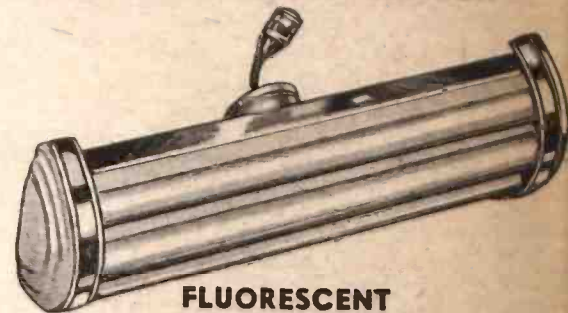

FLUORESCENT KITCHEN UNIT

Fits any standard fixture employing 4" or 6" diameter dome holder. Ideal for use in kitchens, halls, etc. Lustrous washable baked-on white enamel finish with chrome trim. Employs three 24" 20 watt fluorescent lamp bulbs. Operates on 110 volts 60 cycles AC. Shipping weight 9 lbs.
K25584—Less bulbs. Lots of 3, each \$6.23.
YOUR COST SPECIAL, SINGLY.....\$672
K25581—Similar to above but two-lamp. Less bulbs.
YOUR COST, SPECIAL.....\$435

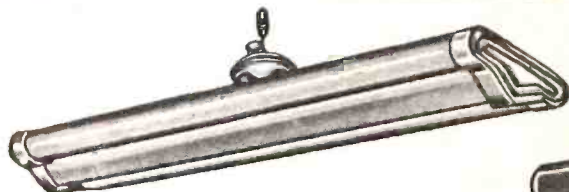

DOME (KITCHEN) FIXTURE ADAPTER

A simple means whereby fluorescent lighting can be installed instantly in any incandescent type of fixture employing a globe with either a 4" or 6" diameter holder. No technical knowledge required — just insert plug of adapter into lamp socket — fasten adapter in shade-holder and enjoy modern, better lighting. **UNDERWRITERS' APPROVED STARTERS AND BALLASTS** Employs two 20-watt (24 inch) lamps. For 110-120 volts 60 cycles AC only. Finished in bright chrome and white baked enamel. Size: 24x9x6". Shpg. wt. 11 lbs. Lamps not included.
K25581—YOUR COST EACH.....\$460
 Lots of 6,
YOUR COST EACH.....\$427



DUAL "40" INDUSTRIAL UNIT

For all commercial applications — factories — garages, etc. Employs two 40" 40-watt lamps. Heavy baked white enamel reflector for maximum efficiency. **Power Factor Corrected**. Tulamp ballast with **Compensator** assures quick starting of second lamp, minimizes stroboscopic effect. Housing of steel with durable baked black enamel finish. Has conduit knockouts. For 110-125 volts 60 cycles AC operation only. Size: 60" long, 11½" wide. With 8-ft. chains and starters—ready to hang. **UNDERWRITERS APPROVED**. Lamps not included.
K25544—Shpg. wt. 38 lbs.
YOUR COST, EACH.....\$1296
 Lots of 6,
YOUR COST, EACH.....\$1196



FLUORESCENT DESK LAMP

Excellent for home and office at a remarkably low price. Gives soft pleasing light, easy on the eyes and exceptionally cool. Almost complete elimination of glare and extremely high "see-ability". Durable light brown morocco finish with inner surface of parabolic reflector finished in chip-proof white enamel. 3-position switch eliminates need for separate starter. Convenient pen trough. Base 10½" long by 5¼" wide. Stands 14½" high with shade 18" long. For 110-125V. 60 cycles AC. Shipping weight 12 lbs.
K25551—Less Lamp. (Requires 15W, 18" Lamp.)
 Lots of 6, \$3.57.
YOUR COST, SPECIAL.....\$386

G.E. MAZDA FLUORESCENT LAMPS

Still the best fluorescent lamps. White lamps provide a quality of light similar to the incandescent lamp. Daylight lamps to ordinary daylight. Average life over 2500 hours.

DAY-LIGHT		WHITE			
Stock #	GE. No.	Dimen. L x D	Watts	YOUR COST	Lots of EACH
K25534	T-5	9x5/8"	6	\$1.00	5 \$0.80
K25497	T-8	18x1"	15	.85	6 .68
K25536	T-12	24x1 1/2"	20	1.10	5 .88
K25538	T-8	36x1"	30	1.10	5 .88
K25540	T-12	48x1 1/2"	40	1.60	4 1.28
K25532	T-17	60x2 1/8"	100	3.50	2 2.80
K25533	T-5	9x5/8"	6	\$1.00	5 \$0.80
K25496	T-8	18x1"	15	.85	6 .68
K25535	T-12	24x1 1/2"	20	1.10	5 .88
K25537	T-8	36x1"	30	1.10	5 .88
K25539	T-12	48x1 1/2"	40	1.60	4 1.28
K25531	T-17	60x2 1/8"	100	3.50	2 2.80

Lafayette 2-BAND 5-TUBE AC-DC SUPER

Performs wonderfully—yet is exceptionally low in price. Not a midget—in appearance or performance. It stands full 7¾" high, 11" long and 6¼" deep. The molded plastic cabinet is cream-ivory in color with brocade speaker grille and illuminated full vision dial in complementary dull gold.
FIVE TUBE SUPERHETERODYNE CIRCUIT—employs the following tubes: 1-6K8GT converter, 1-6K7GT IF amplifier, 1-6SQ7GT detector—1st audio amplifier, 1-25L6GT "beam power" amplifier and a 25Z5G power rectifier.
MAGIC ANTENN-AIRE—Improved type built-in loop antenna eliminates need for external antenna on the broadcast band. No ground connection is required.
FIVE-INCH PM DYNAMIC SPEAKER—accurately matched to output of audio system assuring excellent tone quality.
TWO-BAND OPERATION—for domestic broadcast band from 550 to 1500 kc (200 to 550 meters) and international short wave band from 6.5 to 22 mc. (13 to 49 meters). Important short wave channels clearly identified with name of each country opposite its own particular channels.
BEAM POWER AMPLIFIER—assures maximum power output with minimum current consumption. A large set feature.
AUTOMATIC VOLUME CONTROL—incorporated to keep output volume at constant level.
VOLTAGE CONTROL—ballast tube controls voltage applied to tubes and eliminates usual "hot" power cord.

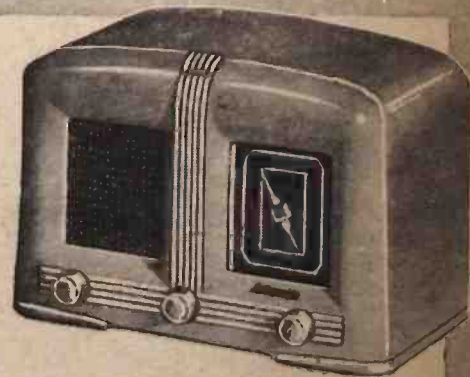

MODEL AB-138—Lafayette 2-Band 5-Tube AC-DC Superhet complete with tubes. For 110 volts DC or 60 cycles AC. Shpg. wt. 11 lbs.
YOUR COST SPECIAL.....\$1095

UES



THAT WILL KNOCK YOU OFF YOUR FEET

RCA ELECTRONIC CONTROLS

A "Natural" for Servicemen. Convert Summer Hours into Cold Cash. Genuine RCA Controls at Over 50% Off

CAPACITY OPERATED CONTROL (Left)

Works instantly at the mere approach of person's body or similarly sized object. No light beams used. Excellent for many applications such as burglar-proofing, door-opening, window lighting, live stock counting, etc. Due to its unique operating principle, protection is easily attained from all directions simultaneously. Great sales appeal to jewelers, storekeepers, etc. Operates from any 110 volt 50/60 cycles a.c. line. Includes a 6SQ7, 6F8G, VR-150-30 and a 6X5 and full instructions. In attractive sturdy metal case 12 x 4 x 6 1/4" high. RCA No. 41903. Shpg. wt. 8 lbs.

K17193—YOUR COST SPECIAL \$795

PHOTO-ELECTRIC CONTROL (Right)

Operates on the popular beam-of-light principle. When any object cuts off the beam the control is set into operation. Widely used for door-opening, counting traffic on roads or in buildings and stores, window-lighting or burglar proofing, automatic garage doors, and many others. Designed for operation on 110 volts 50/60 cycles a.c. Supplied with these tubes: 925, 6SF5, 6SQ7 and 6L6. Operates from any light source, minimum 2 foot-candles, such as 15-watt bulb at 3-feet. Provides momentary control with automatic reset. In attractive sturdy metal case 12 x 4 x 6 1/4" high. Shpg. wt. 6 1/2 lbs.

K17194—RCA No. 41904—YOUR COST \$995



\$795



\$995

SPECIAL



QUALITY Magnetic Pickup

A really swell buy in a quality magnetic pick up. 10,000 ohm high impedance pick-up for new unit or replacement use. Entire arm lifts easily on a swivel for easy needle replacement. Sturdy metal tone arm finished in attractive statuary bronze. For use with both 10" and 12" records. Complete with mounting nut; standard wire leads.

Shpg. wt. 2 lbs. **K13432—YOUR COST \$149**

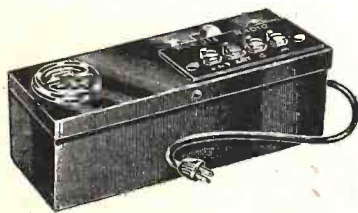

RCA Power Line Filter

A marvelous little RCA power line filter that solves your antenna problems. If you find it impossible to install an outside aerial this unit can take its place. Or, if you have an outside aerial and pick up annoying line hum, electric motor noises, etc., this filter is plugged into your electric outlet and presto—interference is reduced to practically nil. A really scientific coupling unit designed by the RCA labs.

5 3/4 x 1 3/4 x 1 3/4". Shpg. wt. 2 lbs. **K17192—YOUR COST 79c**



\$1.25 NOW 45¢ ea.

RCA-VICTOR MANUALS

Invaluable to Servicemen

Grab this opportunity to complete your important RCA-Victor Service Notes library at the greatest savings ever offered. Regular List on these books is \$1.25 each. Also available in sets of six.

No.	Year	Pages	No.	Year	Pages
K19971	'23-'28	672	K19965	1935	532
K19950	1933	340	K19966	1936	549
K19964	1934	384	K19967	1937	384

Set of six, listed above..... **\$1.98**

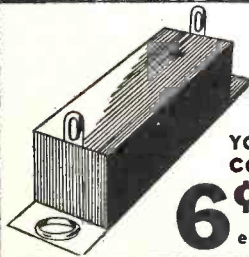

YOUR COST 6¢ each

SERVICEMEN'S SPECIAL

12 Mfd.-25 Volt Dry Electrolytic. A fine cardboard dry electrolytic for all around use. 2 1/4 x 7/8 x 1/8". Mounting centers 3/8" apart. Quantity extremely limited. **K804—**



\$395

BUILD-YOUR-OWN KIT All-Electric Record Player

This money-saving kit will enable you to build your own all-electric record player at a tremendous savings. Contains (1) Constant Speed self-starting (78 r.p.m.) motor, rim-drive, with 9-inch flocked turntable for 110 volts 60 cycles AC.; (2) Offset head latest type crystal pick-up with 8 1/2" arm. Plays all 10" and 12" records. Shpg. wt. 5 lbs.

K690—YOUR COST, SPECIAL \$395

RADEX POCKET TRACER



A very handy, ingenious portable unit useful for trouble tracing in all a.f. and r.f. circuits. Consists of a multi-vibrator generating a signal covering most frequencies. Signal is traced from antenna to point of fault. Easily isolates inoperative stage. 5 1/2" long, 3/8" diam. Complete with battery. Shpg. wt. 1 lb.

K10474—YOUR COST \$196

Reversible Miniature Electric Motors



Adaptable to a wide variety of uses—photo developing agitators, timers, model work, etc., wherever light duty motor for intermittent use is needed. Instantly reversible. Speed approximately 2200 r.p.m. Shpg. wt. 1 lb.

K14702—YOUR COST, SPECIAL 59c

Lafayette

100 SIXTH AVE., NEW YORK

901 W. JACKSON BLVD., CHICAGO

265 PEACHTREE ST., ATLANTA

boston • newark, n. j. • bronx, n. y. • jamaica, l. i.

LAFAYETTE RADIO Dept. 3G1
901 W. Jackson Blvd., Chicago, Ill.
or 100 Sixth Ave., New York, N. Y.

- I enclose \$..... Rush my order.
 Please rush FREE catalog.

NAME.....

ADDRESS.....

CITY.....

STATE.....

(Remittance should include postage)



Here described are the details of constructing the radio and sound console, the theoretical description of which was given in Part I (May Radio-Craft). Every effort has been made to present an ultra-modern design at the lowest possible cost and in as compact form as possible.

◀ The front view of the completed P.A. - Radio - Recording Console shows the speaker grille, left, and above, the addition (at left) of the recording turntable. Otherwise, the equipment appears about as shown in Part I.

How to Build a Modern 30/15-Watt P.A. - RADIO - RECORDING CONSOLE

R. J. BERGEMANN, JR.

PART II

PART I of this article, in the May issue, discussed the reasons for building this unit, the main points of design, and the important or unusual circuits. This Part (II) will be devoted to the construction details.

CHASSIS AND PANEL

The first step is to construct the chassis and front panel. As seen from the drawing of the chassis, they are made from 1/16-in. metal plates, 8 x 18 ins., bent 2 ins. from one end. This can be done before drilling. The placement of all main parts is given. The chassis should be drilled, and the larger parts mounted before the chassis are fastened together with small brass strips. After this, the chassis should be mounted on the wood strips that are eventually fastened to the cabinet. After the cabinet is completed, the bottom of the chassis is accessible by removing the bottom of the cabinet. The front panel is made from 1/4-in. 3-ply wood. Although this may seem too thin, it is very strong and easy to work with. Since the panel is securely fastened to the chassis with small angles, it is very rigid in spite of its comparative thinness.

When the main parts have been mounted, and the front panel is fastened, the whole chassis unit may be inverted and wired. Be sure to use shielding where indicated.

The leads from the mike connectors in the rear, to the switches and controls in the front should be of low-capacity shielded wire. The transformers and chokes specified have a very low temperature rise, and the unit may be operated for a long period with only normal heating.

The chokes are rated at full D.C., and the result is a hum level that is almost inaudible with the master gain wide open; the gain is sufficient to operate a mike from a phono channel with good volume!

The completed electrical unit can be checked before mounting in the cabinet. The tuning eye can be used in aligning the receiver. No bugs were encountered in the original amplifier. Everything worked right off the bat.

CABINET

After completing the electrical part, the cabinet should be built. Use 1/2-in. 5-ply fir except for the motor board which is 3/8-in. plywood. Little woodworking skill is neces-

sary to produce a nice-looking job. Fasten the parts together with glue and screws, and after rounding the corners (as shown in photos) paint with blue-gray enamel. Lights may be put in the sides if desired, to illuminate the panel.

Space is provided in the cabinet for an 8-in. monitor speaker. If recordings are to be played back at high volume without external speakers, the monitor speaker should be of a specified type, especially designed for high power. If the playback at high levels is accomplished through external speakers, as it is in the writer's case, and the contained speaker is not fed more than 5 watts, a higher-fidelity speaker may be used. One available type provides exceptionally fine response from 50 to 10,000 c.p.s., and is therefore ideal for monitoring. A monitor speaker connection to the electrical unit is made through tip-jacks. To provide better baffling, rockwool should be tacked to the walls of the cabinet around the speaker.

The cabinet is now ready to house the electrical unit. The cabinet slips right over the chassis, and is fastened with screws and brass angles. At this time, the dial can

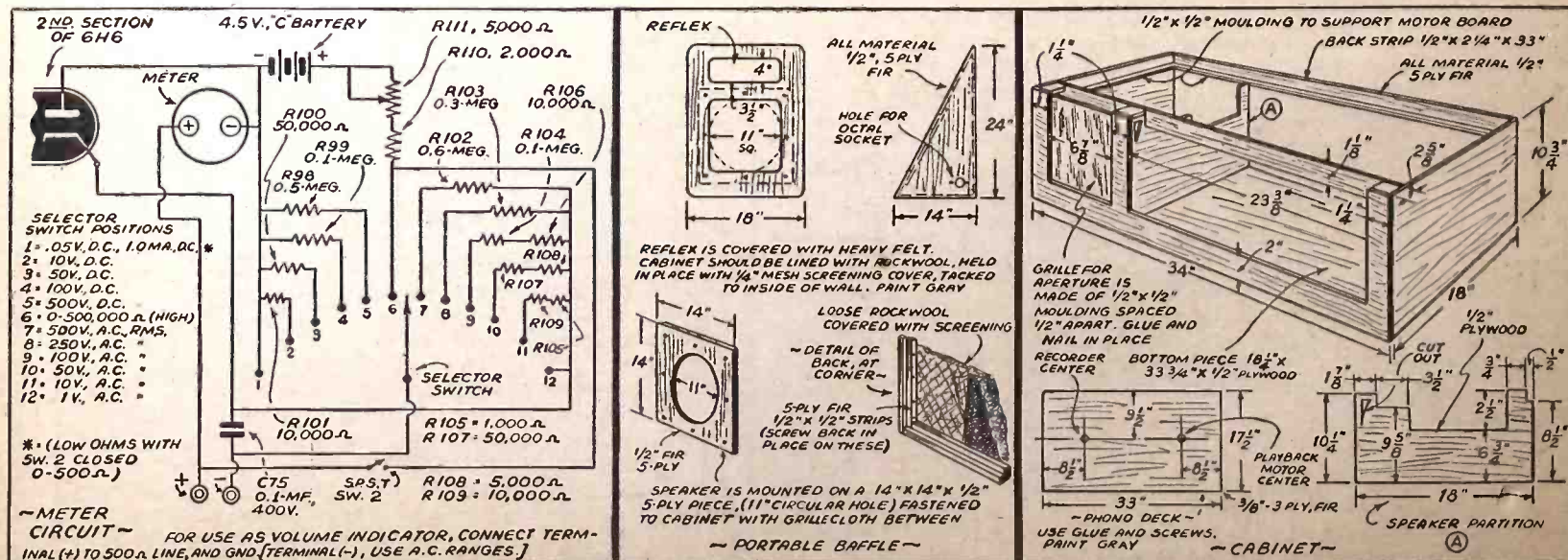

The 2 110-V. outlets in parallel, in Fig. 7, are for (1) the turntables and (2) recording light (see Part III for details).

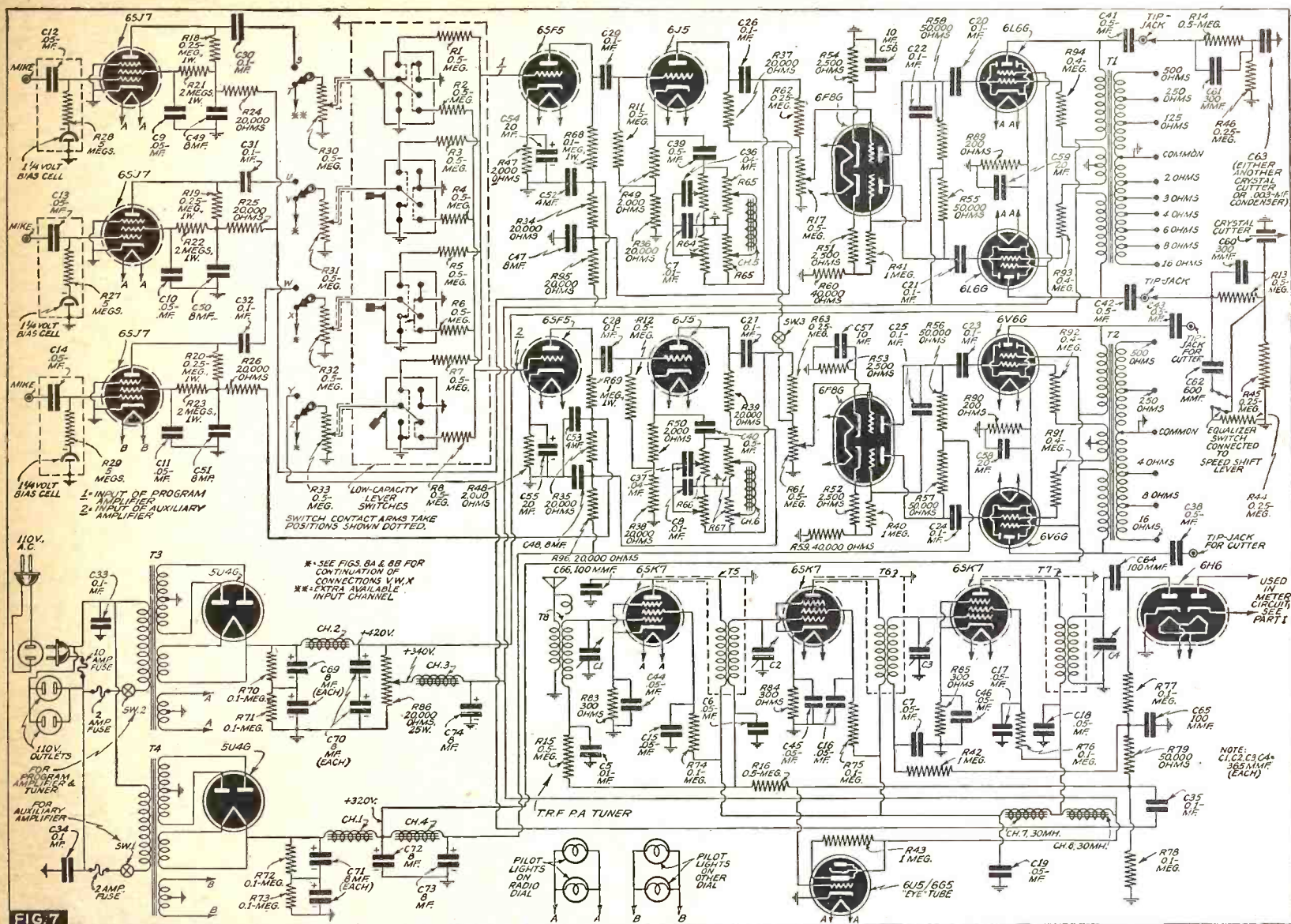

be adjusted to the tuning condenser. Set both at an end position and put on the fabric belt to connect the dial drive with the tuning condenser shaft.

The deck is made next, and the motors centered as shown in the illustration. The recording mechanism used is a dual-speed unit (see List of Parts). Out of all the semi-pro. basic recording mechanisms tested, this model had the lowest motor growl, and the least amount of wows.

RECORDING—DUBBING—PLAYBACK

A lever switch was later added to connect the crystal cutter to either amplifier, or to disconnect it. Note that condenser C63 may be replaced with another crystal cutter if the constructor wishes to use an auxiliary recording mechanism in the future. Pickup P3 is used only for playing-back acetate discs. Either the crystal unit, P1B, or the magnetic type, P1A, should be used to play commercial records on the variable-speed motor.

It is convenient in dubbing, to be able to change the pitch or speed of the background music. Also since all except the very-high-priced recorders drop speed slightly in recording, it is necessary to use a variable-speed motor if many successive dubbings are to be made. Audio discs were used for testing and, in conjunction with pickup P3, playback provided exceptionally long record life with low background noise. (When these Audio Discs are cut with a sapphire needle by the manufacturer, the surface noise is as much as 20 db. lower than that of commercial pressings, which does a great deal in making records seem more lifelike.)

The cutter supplied has good response between 30 and 7,000 c.p.s. Average modulation of the record is obtained when the

meter across the 500-ohm line reads about 40 volts. Overloading will be noticeable by "echoes," distortion, and cut-over between adjacent grooves. The depth of cut adjustment should be set to give about a 2½ thousandths (0.0025-in.) cut for average work. Once set, it need not be changed throughout the life of the cutting stylus. Since 2 dual-speed motors are used, it is possible to dub from one speed to the other and make long-playing recordings from records originally recorded at 78 r.p.m.

Incidentally, connections are made to the phono deck by means of plugs and cables. The deck can quickly be removed to get at the tubes. The two 110-V. outlets in parallel, in Fig. 7, are for (1) the turntables and (2) a recording light (see Part III for details).

From microphone to crystal cutter, and back from pickup to speaker, this unit provides wide-range frequency response at low distortion. With a little experience (which is quickly acquired with this instrument), the constructor can expect to get results that are equal to if not better than those obtained in expensive commercial recording studios.

LIST OF PARTS

- RESISTORS**
 Seventeen I.R.C., type BT½, 0.5-meg., R1 to R16 incl., R98;
 Three I.R.C., type BT½, 5 megs., R27, R28, R29;
 Three I.R.C., type BT1, 0.25-meg., R18, R19, R20;
 Three I.R.C., type BT1, 2 megs., R21, R22, R23;
 Eleven I.R.C., type BT½, 20,000 ohms, R24, R25, R26, R34 to R39 incl., R95, R96;
 Four Centralab No. 72-105, 0.5-meg. potentiometers, R30 to R33 incl.;

- Four I.R.C., type BT½, 1 meg., R40 to R43 incl.;
- Five I.R.C., type BT½, 0.25-meg., R44, R45, R46, R62, R63;
- Five I.R.C., type BT½, 2,000 ohms, R47 to R50 incl., R110;
- Four I.R.C., type BT½, 2,500 ohms, R51 to R54 incl.;
- Eight I.R.C., type BT½, 50,000 ohms, R55 to R58 incl., R79, R80, R100, R107;
- Two I.R.C., type BT½, 40,000 ohms, R59, R60;
- Two I.R.C., type CS-13-133, 0.5-meg. potentiometers, R17, R61;
- Four Thordarson No. R1068, tone control potentiometers, R64 to R67 incl.;
- Six I.R.C., type BT1, 0.1-meg., R68 to R73 incl.;
- Seven I.R.C., type BT½, 0.1-meg., R74 to R78 incl., R99, R104;
- One I.R.C., type DHA, 10 ohms, 25 watts adjustable, R81 (set at 8 ohms);
- One Utah, type LA-8, 8 ohms, 15 watts, L pad, R82;
- Three I.R.C., type BT½, 300 ohms, R83, R84, R85;
- One I.R.C., type DHA, 20,000 ohms, 25 watts, adjustable, R86;
- Two I.R.C., type BT½, 2 megs., R87, R88;
- Two I.R.C., type ABA, 300 ohms, 10 watts, adjustable, R89, R90 (Set at 200 ohms);
- One I.R.C., type EPA, 1,000 ohms, 50 watts, adjustable, R97 (Set at 500 ohms across 500-ohm winding of output transformer for power and frequency response tests on amplifiers.);
- Four I.R.C., type BT1, 0.4-meg., R91 to R94 incl.;
- Three I.R.C., type BT½, 10,000 ohms, R101, R106, R109;
- One I.R.C., type BT½, 5,000 ohms, R108;
- One I.R.C., type BT½, 1,000 ohms, R105;
- One I.R.C., type BT1, 0.6-meg., R102;

EFFICIENCY is the Magic Word
 The Reason Why a Single
**UNIVERSITY REFLEX
 HIGH EFFICIENCY
 SPEAKER**
 does the work of three
 ordinary low efficiency
 speakers.
UNIVERSITY
 Reflex Speakers have
 highest possible effi-
 ciency, far greater than
 any other type of loud
 speaker.
 Write for new catalogue sheets
UNIVERSITY LABORATORIES
 195 Chrystie Street
 New York City

FREE!
**HAMMARLUND
 NEW "41"
 RADIO CATALOG**
 The latest Hammarlund catalog with
 complete data, illustrations, draw-
 ings and curves on the entire Ham-
 marlund line. Address Department
 RC-7-1 for your free copy.
HAMMARLUND MFG. CO., INC.
 424-438 West 33rd Street, New York City

ELECTRIC LANTERNS

\$3.19



← No. 400. Price
 \$3.19. 1500 foot
 Power Beam. Two re-
 flectors. Steel con-
 struction. Finished
 ebony baked enamel.
 Takes standard 6 v. Bat-
 tery.



No. 500. Price \$1.48.
 1000 foot Power Beam.
 Size: Height 7". Steel
 construction. Finished
 baked lacquer. Takes
 standard 6 v. Railroad
 type Battery.

\$2.69

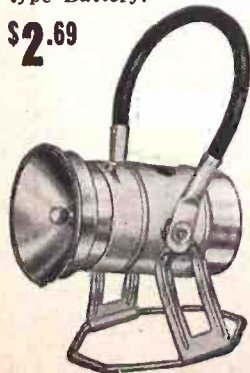

← No. 600. Price
 \$2.69. 1500 foot
 Power Beam. Steel
 drawn construction.
 Unbreakable plastic
 lens. Takes standard
 6 v. Battery.

Shipping weight for any
 of the above Models
 3 lbs. Furnished with-
 out Batteries.

All merchandise in original packages—never used.
 Money-back guarantee.

All Shipments will be forwarded by Express
 Collect if not sufficient postage included.

WELLWORTH TRADING CO.
 1915 So. State St. Dept. RC-741 Chicago, Ill.

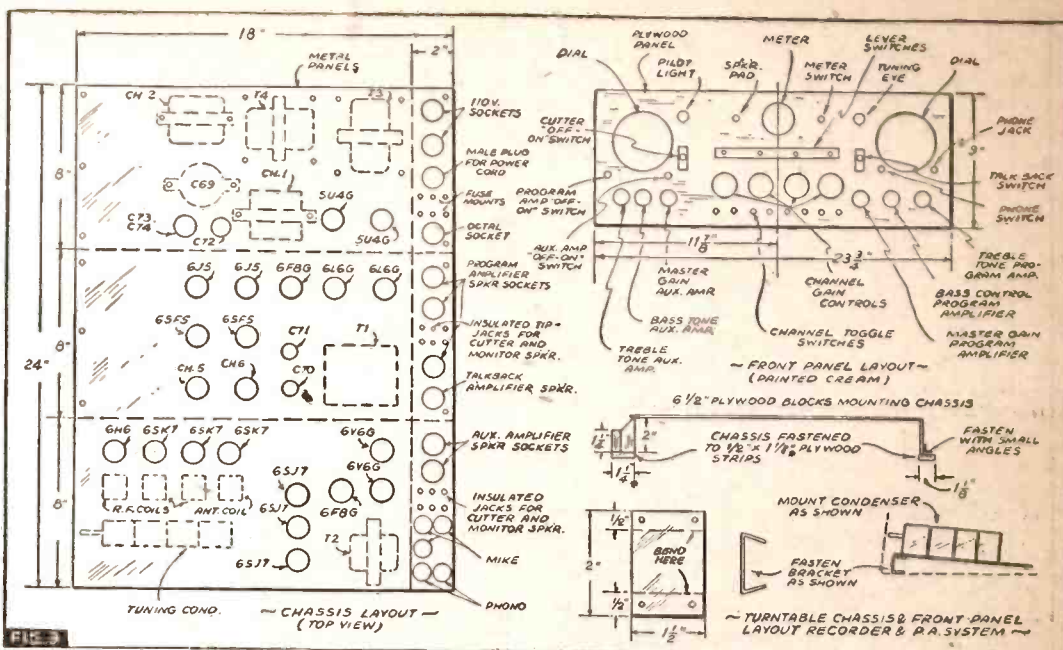

One I.R.C., type BT1, 0.3-meg., R103;
 One I.R.C., type VF-135, 5,000 ohms, rheo-
 stat for meter ohms adjustment, R111.

CONDENSERS

- One Meissner, type 21-5223, tuning con-
 denser, 365 mmf., C1, C2, C3, C4;
- Four Cornell-Dubilier, type DT-4S1, 0.01-
 mf., 400 V., C5 to C8 incl.;
- Eleven Cornell-Dubilier, type DT-4S5, 0.05-
 mf., 400 V., C9 to C19 incl.;
- Seventeen Cornell-Dubilier, type DT-4P1,
 0.1-mf., 400 V., C20 to C35 incl., C75;
- Five Cornell-Dubilier, type DT-4S4, 0.04-
 mf., 400V., C36, C37, C44, C45, C46;
- Six Cornell-Dubilier, type DT-4P5, 0.5-mf.,
 400 V., C38 to C43 incl.;
- Five Cornell-Dubilier, type BR-845, 8 mf.,
 450 V., C47 to C51 incl.;
- Two Cornell-Dubilier, type BR-445, 4 mf.,
 450 V., C52, C53;
- Two Cornell-Dubilier, type BR-202A, 20 mf.,
 25 V., C54, C55;
- Two Cornell-Dubilier, type BR-102A, 10 mf.,
 25 V., C56, C57;
- Two Cornell-Dubilier, type BR-205, 20 mf.,
 50 V., C58, C59;
- Two Cornell-Dubilier, type 5W5T3, 300
 mmf., C60, C61;
- One Cornell-Dubilier, type 1W5T6, 600
 mmf., C62;
- One Cornell-Dubilier, type 1W503, 0.003-mf.,
 C63;
- Three Cornell-Dubilier, type 5W5T1, 100
 mmf., C64, C65, C66;
- Two Cornell-Dubilier, type 5W5T25, 250
 mmf., C67, C68;
- One Cornell-Dubilier, type EA-8800, 8-8 mf.,
 C69 (connect in series);
- Two Cornell-Dubilier, type EB-8800, 8-8
 mf., C70, C71 (connect in series);
- One Cornell-Dubilier, type EB-11800, 8 mf.,
 475 V., C72;
- One Cornell-Dubilier, type EB-8800, 8-8 mf.,
 450 V., C73, C74.

TUBES

- Two Raytheon 6L6G;
- Two Raytheon 6V6G;
- Two Raytheon 6J5G;
- Two Raytheon 5U4G;
- Two Raytheon 6F8G;
- One Raytheon 6H6;
- One Raytheon 6U5/6G5;
- Three RCA 6SK7;
- Two RCA 6SF5;
- Three RCA 6SJ7.

MISCELLANEOUS

- One Thordarson T-15S92, CHT "Multi-tap"
 output trans., T1;
- One Thordarson T-17S11, Output trans.,
 T2;

- One Thordarson T-92R21, Power trans., T3;
- One Thordarson T-70R62, Power trans., T4;
- One Thordarson T-17C00-B, filter choke,
 Ch1;
- One Thordarson T-67C49, filter choke, Ch2;
- Two Thordarson T-43C49, filter choke, Ch3,
 Ch4;
- Two Thordarson T-14C70, tone control
 choke, Ch5, Ch6;
- Two Meissner No. 14-7860, Interstage R.F.
 choke, Ch7, Ch8;
- One Meissner No. 14-1497, Output R.F. coil,
 T7;
- One Meissner No. 14-1496, Ant. coil, T8;
- Two Meissner No. 19-1906, 30 mhy. R.F.
 choke, Ch. 7, Ch. 8;
- Two Meissner No. 23-8257, 4-in. airplane
 dial;
- One Amphenol No. MEA-6, tuning eye as-
 sembly;
- Twenty-six Amphenol No. MIP octal
 sockets;
- Two Amphenol No. 61-F, receptacle;
- One Amphenol No. 61-M, receptacle;
- One Amphenol No. 61-F4, receptacle;
- Three Amphenol No. 61-M4, power plug;
- Four Amphenol No. PM8, speaker plug;
- Five Amphenol No. MC1F, mike connector;
- Three Amphenol No. CL-PC1M, chassis con-
 nector;

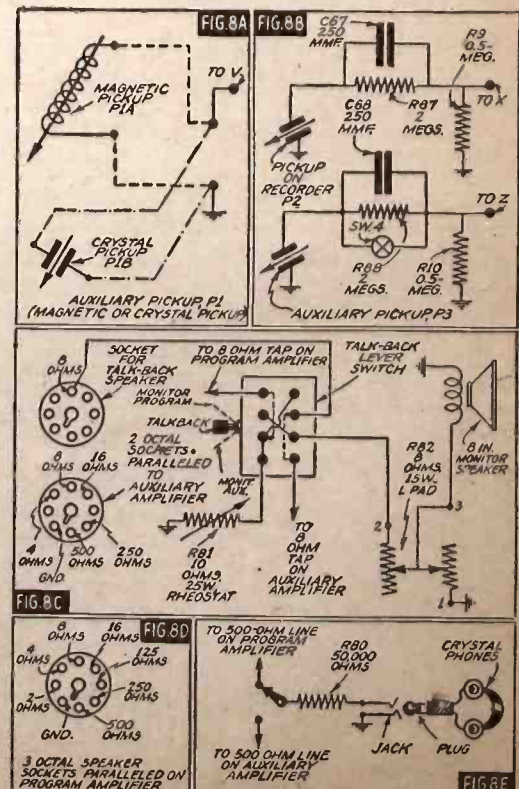

See Fig. 7 for connections of these circuits.

- Two Amphenol No. PC1M, chassis connector;
- Three Bud No. PS-1187, 8 x 18 in. metal plates for chassis;
- One Bud No. 590 microphone banquet stand;
- One Bud No. SL-1699-SB, pilot light jewel;
- One Bud No. FB-230, phone plug;
- Two Bud No. 1226, etched dial plate Gain;
- Four Bud No. 1227, etched dial plate Tone;
- Two Bud No. 1181, etched plate Phono Pickup;
- Three Bud No. 1180, etched plate Microphone;
- Six Centralab No. 1452, low-capacity lever-action switches;
- One Yaxley No. 3100, rotary switch, for meter;
- One Lafayette 3-in. foundation meter, 0-1 ma.;
- Six Birnbach No. 293-18, varnished tubing, 2 each, red, green, yellow;
- Three Birnbach No. 294-16, tubing, 1 each, red, green, yellow;
- Five Birnbach No. 82-25, hookup wire, 1 each, black, red, green, white, yellow;
- Three Birnbach No. 282-25, hookup wire, 1 each, black, red, yellow;
- Twenty ft. No. 818 shielded grid wire;
- Ten ft. No. 820 grid lead wire;
- One Astatic, FP-38, 1-oz. crystal pickup with sapphire stylus, P3;
- One Webster-Electric, X82AND crystal pickup, P1B, or 40A5 magnetic pickup, P1A;
- One "Electro-Voice" No. 725 "Cardak" microphone;
- One Jensen high-power PAH-8 or Cinaudagraph high-fidelity LM-8-8 monitor speaker;
- Two Utah Type G12P 12-in. P.M. speakers for portable cabinets;
- One General Industries model H 2-speed phono motor with 12-in. weighted turntable;

New SELF-BALANCING
DRIFT-CORRECTING

DIRECT-COUPLED AMPLIFIERS

FOR DISCRIMINATING MUSIC LOVERS

Designed by A. C. Shoney



These new amplifiers bridge the gap between the laboratory and the home, and make available for the first time, extraordinary equipment at less than ordinary prices. Built in a new way, without interstage coupling condensers or transformers. Although specifically designed to meet the strictest requirements of professional sound engineers, these direct-coupled amplifiers embody all desirable features sought by the most discriminating music lovers. Send for Literature.

AMPLIFIER CO. of AMERICA
17 W. 20TH STREET, NEW YORK, N. Y.

- One pair Brush type A high-fidelity crystal earphones;
- One No. 3629 sapphire stylus (for recording);
- One Wilcox-Gay No. A-102, dual-speed recording mechanism, with pickup, P2;
- Switches, knobs, hardware, solder, etc.

Part III will describe the "tricks of the trade," that will make possible recordings with this Console, which will approach with remarkable perfection the discs made by commercial houses using much more costly, cumbersome and complicated equipment. Other details of the apparatus and its uses will be discussed.

BOOK REVIEWS

I LIVE ON AIR, by A. A. Schechter with Edward Anthony (1941). Published by Frederick A. Stokes Co., New York. Cloth covers, size 6 1/4 x 9 1/2 ins., 582 pages, 64 illustrations. Price \$3.75.

In "I Live on Air," a director of news and special events for N.B.C., in collaboration with the author of "Bring 'Em Back Alive," gives a back-of-the-mike story of interest to those who are willing to stay with this mainly first-person human interest discourse on the activities of a radio news broadcaster.

Of exceptional esthetic interest is the "picture gallery" of 64 full-page reproductions of photographs which conclude the book.

Chapter headings selected at random from the total of 27 are: Chapter VII, My Day; Chapter XVI, Blow by Blow; Chapter XIX, Of Mikes and Men; Chapter XX, Battle of Pitcairn Island; Chapter XXIII, Vox Pop Enlivens Things.

PATENT FUNDAMENTALS (1941), by Leon H. Amdur. Published by Chemical Publishing Co., New York. Cloth covers, size 5 1/2 x 8 3/4 ins., 293 pages, illustrated. Price \$4.00.

Answers questions such as: Where can I get a book which will give me some background for understanding patents? Where can I find a simply-written book on patents which I can use for outside reading? Isn't there some book which will give me a general idea of what patents are all about?

It is a book on patents which is elementary and yet comprehensive. It is written by a member of the New York Bar, a former Patent Examiner, and now a Patent Attorney. One major purpose of this book has been to enable the layman and the student to easily understand the U. S. Patent System. Another has been to offer philosophical and historical treatment of the difficult science of patent classification, including plant patents.

Contents: Types of Inventions; Nature of a Patent; How Patents Are Classified; Preparation and Prosecution of Application; Invention as Defined by Patent Claims; What Is Invention?;

Utility, Immorality and Frivolity; Plant Patents; Dealings in Patents.

1941 YEARBOOK NUMBER—An Annual Publication of Broadcasting—Broadcast Advertising Magazine, Hard paper covers, size 12 x 9 ins., 476 pages. (Subscription premium.)

Each year, the magazine "Broadcasting—Broadcast Advertising" compiles a volume for the benefit of the broadcast stations; and each year sees a further step taken in the perfection of this presentation. The current book incorporates the following features: Havana Treaty Assignments by Call Letters; Havana Treaty Assignments by Frequencies; Havana Treaty Assignments by States and Provinces; Havana Treaty Assignments (Canadian); Defense Communications Board: Organization-Function; Highlights and Headlines: 1940; Station Representatives and Their Stations; Success Stories: Summary-Index of Articles on Commercial Successes Carried in "Broadcasting"; NAB Code: Text and Analysis of Rulings; Rules and Standards Governing F.M.; Log of F.M. Stations; Television Rules and Regulations; New Rules and Regulations Governing Broadcasting; Radio Income-Investment-Employment-Payroll Data.

A map "Cities with Standard Radio Broadcast Stations—United States and Canada" is a loose enclosure.

India—Reports to London, quoted in an item to *Radio-Craft* last month, from India and South Africa indicate that the U-boat blockade did not prevent radio exports to the value of over 2 1/2 million dollars (total, including \$100,000 for South Africa) reaching these countries. However, the report continues, high duties and freights keep British radio sets out of the poorer Indian homes, thus establishing a tremendous market for the new low-priced "People's Set" British manufacturers are now designing.



ELEMENTARY MATHEMATICS

• EASY — SIMPLIFIED — PRACTICAL •

HERE is a book for the business man, the technician and craftsman explaining and answering every operation and meaning with interpreting illustrations and examples.

It is the key to a simple understanding of many perplexing problems in daily life.

In clear, positive and definite language, the author popularizes and clarifies every subject and helps the reader to overcome any apparent difficulty in the study of mathematics.

A real home study-course in mathematics for the student or the man who wants to achieve proficiency or desires to brush-up on his knowledge.

Entire Chapter on Special Mathematics for the Radio Technician

CONTENTS OF BOOK

- CHAPTER I. Arithmetic—Addition—Subtraction—Multiplication—Division.
- CHAPTER II. Factoring and Cancellation—Fractions—Decimals—Percentage—Ratio—and Proportion.
- CHAPTER III. The Metric System.
- CHAPTER IV. How to Measure Surfaces and Capacity (Geometry).
- CHAPTER V. Powers and Involution—Roots and Evolution.
- CHAPTER VI. Mathematics for the Manual and Technical Craftsman—Thermometer conversions—Graphs or Curve Plotting—Logarithms—Use of the Slide Rule.
- CHAPTER VII. Special Mathematics for the Radio Technician.
- CHAPTER VIII. Commercial Calculations—Interests—Discounts—Short Cut Arithmetic.
- CHAPTER IX. Weights and Measures—Useful Tables.

ONLY
50c
POSTPAID

"Elementary Mathematics" can be carried readily in your pocket. Send Stamps, Cash or Money Order.

TECHNIFAX

1917 S. State St. RC-741 Chicago, Ill.

Make more money faster, with
RCP DEPENDABLE TEST EQUIPMENT

Leading Service Engineers, Training Schools, and Government Departments, specify RCP Test Instruments when they want extra dependability and accuracy. Yet, RCP Test Equipment *actually costs less!* Before you buy any test equipment, investigate RCP. See how much more profit-building equipment your money will buy at RCP. The complete RCP line of Test Instruments, that will help you do any job faster and better, is described in FREE Catalog #125.

SEND FOR IT TODAY
A postcard will do!

RCP
dependable
TEST
instruments

RADIO CITY

PRODUCTS COMPANY, INC.

88 PARK PLACE • NEW YORK, N. Y.

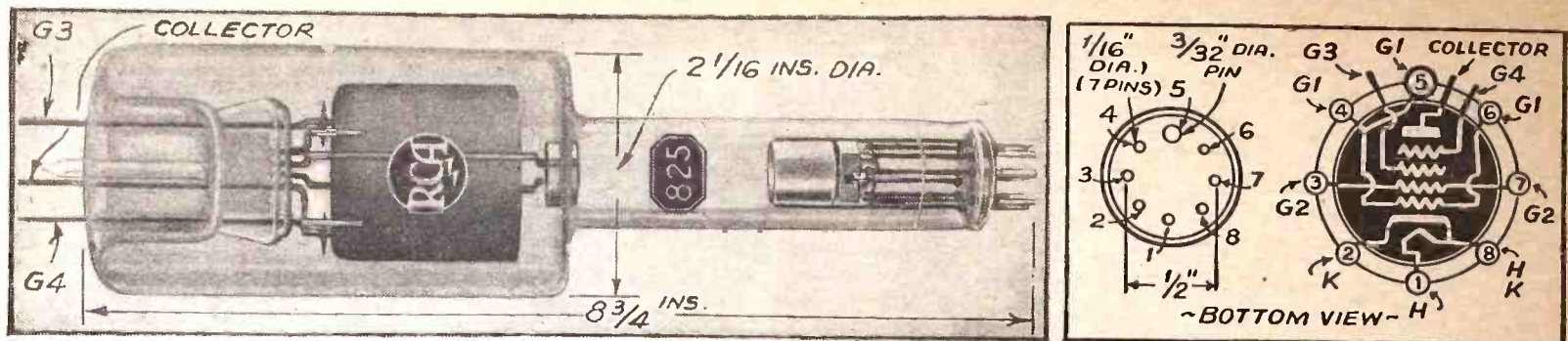

Fig. A. The RCA type 825 Inductive Output Ultra-shortwave Transmitter Tube. The arrangement of the basing and terminals and, extreme right, the symbol for the 825, is shown in this illustration.

24 RECENT RADIO TUBES

Television (including a 1-meter "Inductive Output" type), diathermy, "Reduced Plate Voltage" series, blue-sensitive photocell, airplane-radio, battery/electric "personal portable" and other types of tubes, announced since the last general Radio-Craft article on tube types, are described in this article.

R. D. WASHBURNE

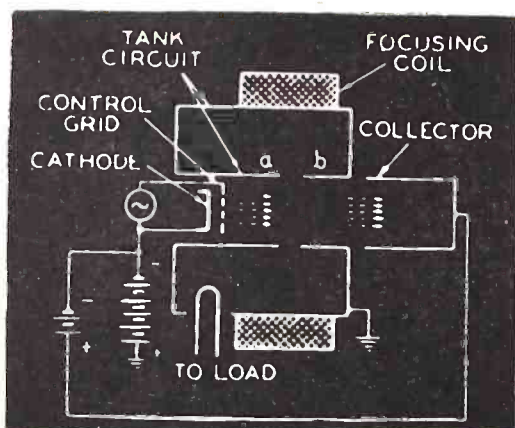

Fig. 1. Theoretical diagram of the "inductive output" type of tube. This design is introduced in the RCA type 825 ultra-shortwave tube. The completed tube is shown in Fig. A. The focusing electromagnet is a double magnet operated at approx. 1,000 ampere-turns.

THE following descriptions of tubes embraces, in numerical order, not only most of the recent types but also includes brief mention of various, less-recent types with which it is felt the technician may wish to make passing acquaintances but which for various reasons were not described in any detail in preceding issues. More complete characteristics data, etc., are available from the manufacturers.

Except for the transmitting types (which are of minimum interest to *Radio-Craft* readers), in which diathermy specialists and a limited number of other groups of technicians may find interest, the appearances of the tubes here described are orthodox and follow the constructions variously identified in the text.

The symbols for most of the tubes described here are shown; the physical appearances are readily identified from the text.

A single exception among the transmitting types, to which it is felt the majority

of *Radio-Craft* readers should pay particular attention, is the "Inductive Output" design. This tube was mentioned in the April issue, pg. 625, as "making possible the streamlining, simplification, efficiency and economy of operation of the (television) radio relay stations" employed in the recent Camp Upton (L.I.)-to-New York television relay transmission, by N.B.C./RCA, demonstrating projection television on a theatre screen measuring 14 x 20 feet.

What are the tube differences, if any, that make possible all these advantages in relay-television? Well, let us find out something about this strange new device, which seems to be so vital an element in the initial stages of development of what soon may become a *Transcontinental Television and Frequency Modulation Network*.

ULTRA-SHORTWAVE

825 Multi-Electrode "Inductive Output" 1-Meter Amplifier

Opening up new possibilities for research and development in the ultra-high-frequency transmitting field, the 825 will be of particular interest to experimenters and engineers working at frequencies above 300 megacycles (1 meter).

It is a new type of multi-electrode tube in which the electron stream is inductively coupled to the output circuit.

The 825 is designed for use as a power amplifier at frequencies above 300 megacycles and in such service is capable of handling power outputs up to 35 watts depending on bandwidth and type of service. Because of its high transconductance and its adaptability to tank circuits having low effective capacity, the 825 is especially suited for wide-band services, such as Television and Frequency Modulation. The 825 may also be used as an oscillator and harmonic generator.

The well-known difficulty of obtaining power at ultra-high frequencies with tubes

of conventional design is due to (1) electron transit-time effects, to (2) interelectrode capacities, and (3) to dissipation problems.

In the inductive-output tube, the electron transit-time effects are minimized by utilizing electrons of high velocity. This is accomplished, without either increased dissipation or loss in efficiency, by separating the functions of both the output electrode and the current-collecting electrode, and by making use of electron focusing. This separation of functions makes it possible to utilize an output circuit of low effective capacity and high efficiency. Furthermore, losses due to high circulating R.F. currents in the output leads of conventional tubes are eliminated.

Figure 1 illustrates the essential elements of an inductive-output tube used as amplifier or harmonic generator. An electron stream originates at the cathode, passes through the control-grid (grid No. 1) and the output electrodes *a* and *b*, and is finally collected at the collector electrode (plate).

The control-grid, which is placed next to the cathode, modulates the electron stream when the input circuit connected between the grid and cathode is excited. The output electrodes *a* and *b* surrounding the electron stream form an integral part of the output tank circuit, which is tuned to the excitation frequency or some harmonic thereof. The passage of the modulated electron stream through the output electrodes *a* and *b* induces a radio-frequency current in the tank circuit, and since this circuit is tuned, a high voltage will be produced across the gap. The phase of this voltage at or near resonance will be such as to decelerate electrons traversing the gap during the half-period of maximum intensity of electron current in the stream. These decelerated electrons are then collected at the low-voltage collector.

The kinetic energy lost by the electrons is transformed by the tank circuit into energy of the electromagnetic field within the space enclosed by the tank circuit. This energy is

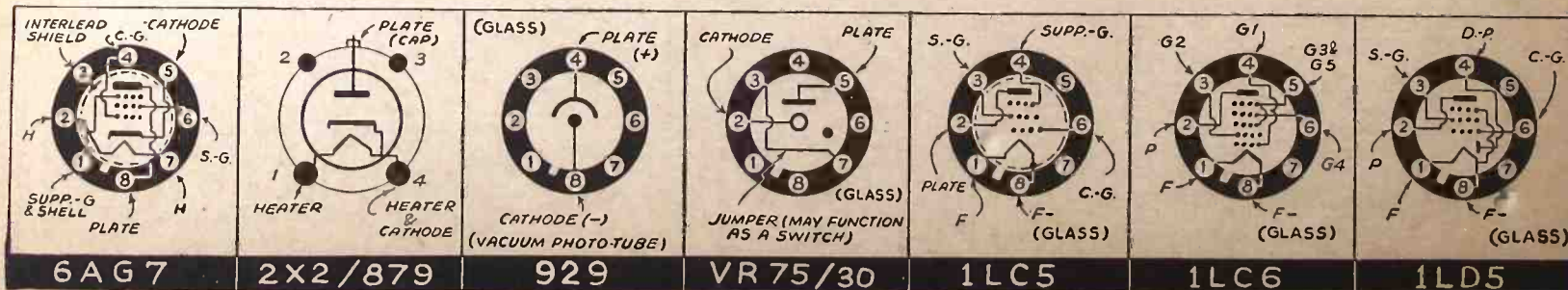

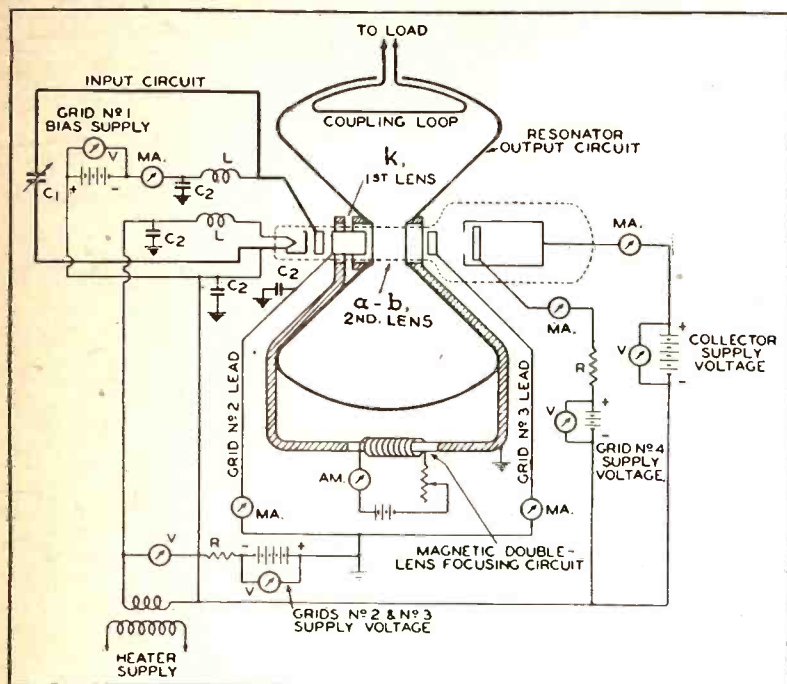

◀ Fig. 2. Typical R.F. amplifier circuit for the type 825 tube. This arrangement is shown pictorially in Fig. B. In the diagram, Unit C1 is the input tuning condenser; C2, bypass condenser; L, R.F. choke; and, R, protective resistor. Note the high voltages at which this tube operates (see text).

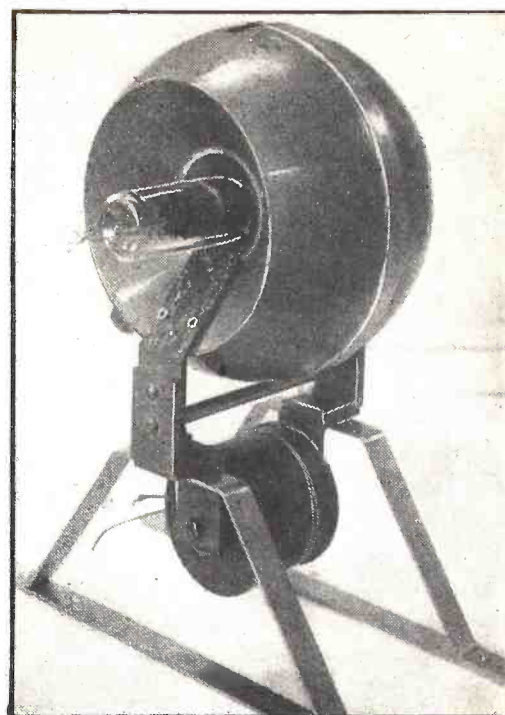

Fig. B. Back view of a developmental R.F. amplifier stage using the RCA 825 at 500 megacycles. An air flow at low pressure through the resonator gap is recommended; this is particularly desirable if the load is to be removed during circuit adjustment as, otherwise, the voltage across the gap may become large enough to puncture the bulb. The spherical enclosure is the resonator.

then transferred to the useful load by means of a coupling loop, as shown in Figs. 1 and 2.

The electron stream is focused into a beam by the combined effects of magnetic and electric fields. While it is possible to focus the electron stream by means of an intense uniform magnetic field in the direction of the beam as shown in Fig. 1, it is preferable to make use of the double-magnetic lens system shown in Fig. 2. The latter arrangement localizes the magnetic field in the regions where it is most needed, and consequently makes the energy required to establish the requisite field considerably less than for the uniform magnetic field. As shown in Fig. 2, the 2 lenses are formed by the gaps *k* and *a-b* in hollow iron cylinders coaxial with the tube. The first lens *k* prevents divergence of the beam caused by the accelerating electrode G_2 ; the second lens *a-b* compensates for divergence caused by the R.F. electric field at the output gap. Because of the low magnetomotive force required to energize the lenses, a permanent magnet may be used for this purpose.

A typical R.F. amplifier circuit for class C operation of the 825 at 500 megacycles is given in Fig. 2. The back view of a developmental R.F. amplifier stage of this type is shown pictorially in Fig. B; the resonator, tube, electromagnet and general arrangement of the parts is shown.

Major characteristics: heater, 0.75-A. at 6.3 V. A.C./D.C., D.C. collector (anode or plate), 32.5 ma. at 2,000 V.; D.C. grid No. 1, -100 V.; D.C. grid No. 2, 3,600 V.; D.C. grid No. 3, 3,600 V.; D.C. grid No. 4, 1,500 V. These figures are per tube, as a grid-modulated R.F. amplifier in class C telephony. Direct interelectrode capacities: G_1 to G_2 , 1.7 mmf.; G_1 to cathode, 3.4 mmf.; G_2 to cathode, 0.9-mmf.—RCA.

826 Triode for Ultra-H.F.

The 826 transmitting triode has been designed especially for use at ultra-high fre-

quencies. It may be used as an oscillator, R.F. power amplifier, and frequency multiplier at maximum ratings at frequencies as high as 250 megacycles and at reduced ratings at frequencies as high as 300 megacycles. Maximum plate dissipation of the 826 is 60 watts in class C telegraph service. The 826 features a double-helical filament center-tapped within the tube so that effects of filament inductance can be minimized. In addition, 2 short, heavy leads are brought out from the grid and from the plate to individual terminals in order to reduce the inductance of these internal connections. All terminals are placed at one end of the bulb so that short leads can be used in neutralizing circuits.

Filament: 4A. at 7.5 V., A.C. or D.C. Typical operation as a grid-modulated R.F. power amplifier in class C telephony: plate, 65 ma. at 1,000 V.; control-grid, -125 V.—RCA.

TELEVISION

6AG7 Video Power Amplifier Pentode

This high-mutual-conductance pentode is designed for use as a video voltage amplifier in television receivers. Metal shell.

Characteristics data are given in Table I.—Raytheon.

2X2/879 Half-Wave Diode High-Vacuum Rectifier

The 2X2/879 is a high-vacuum, heater-type, half-wave rectifier designed for use in suitable rectifying devices to supply the high D.C. voltage requirements of cathode-ray tubes. In a voltage-doubler circuit, two 2X2s may be operated to deliver approximately twice the voltage obtainable from a half-wave rectifier circuit for the same A.C. input voltage. However, a separate heater-supply winding is required for each tube. Metal shell.

Characteristics, Table II.—Raytheon.

ELECTRONIC

929 Caesium-type High-Vacuum Phototube

The type 929 high-vacuum phototube utilizes a new type of caesium photosurface identified as S-4. This new surface has extraordinarily high sensitivity to light sources predominating in blue radiation.

Although the 929 is not infra-red sensitive, it has a sensitivity of 45 microamperes/lumen to light from a tungsten filament operated at 2,870° K. To daylight, its sensitivity is several times greater; to light from a high-pressure mercury arc, many times greater.

In addition to its exceptional sensitivity, the 929 features excellent stability and consistent spectral response. Because of these features, the 929 is well suited for measurement and relay applications.

The spectral sensitivity of this S-4 photosurface in a lime-glass bulb is shown in Fig. 3. Glass bulb. Characteristics, Table III.—RCA.

VR75/30 Voltage Regulator

The VR75/30 is a cold-cathode, neon-filled (and argon-trace), glow-discharge tube, for use as a voltage regulator in applications where it is necessary to maintain a constant D.C. output voltage across a load, independent of load current and moderate line-voltage variations. Like other glow-discharge tubes, it may be used as a relaxation oscillator and for spark-over protection. The VR75/30 maintains a D.C. operating voltage of approximately 75 volts. Pins 3 and 7 are connected together within the base and this connection may be used as a power switch to automatically open the power transformer primary when the regulator is removed from its socket. Glass bulb.

An installation and application circuit is shown in Fig. 4. Tentative characteristics data, Table IV.—RCA

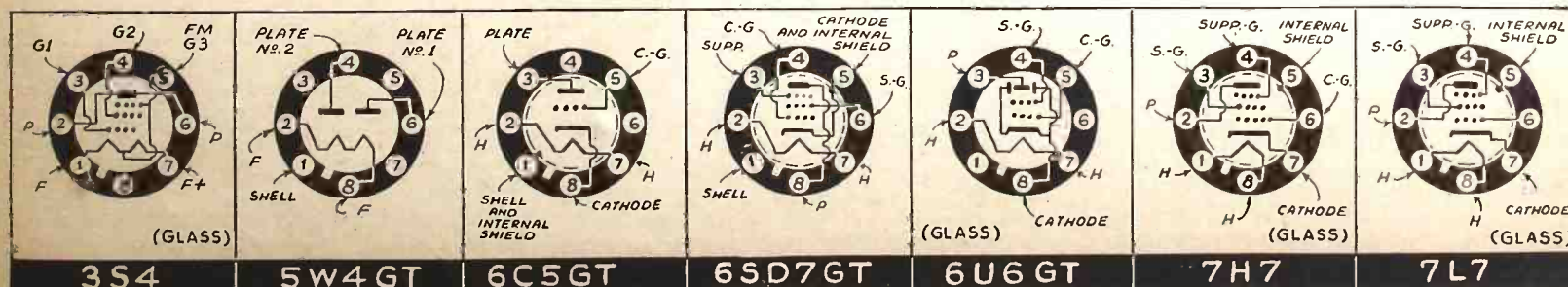

LEOTONE
The House of a Million Parts and a million bargains.
A FEW OUTSTANDING BUYS



DeJur Molded Bakelite Bases; 8 3/4" x 3 1/2"; including 6 resistors, 3 4-prong sockets, 8 binding posts; wired for resistance-coupled amplifiers; can be used for 3-tube shortwave sets or amplifiers. .35c ea.
Gen-Win .00035 Binoc. R.F.'s; matched set of 3 .29c set
Audio Transformers; 3 to 1 ratio .19c ea.
AC Relays; 2" sq.; S.P.D.T.; 5 Amp. contact points; mounted on sturdy diecast base; 1M ohm .98c ea.; 5M ohm .75c ea.
H. Bernard Walnut Meter Boxes; 3" x 5 1/2" x 2 1/4" High; engr. aluminum panel; for 2" meter .49c ea.
Arvin Remote Control Auto Heads; 2 1/2" x 3"; 2" Scale Reading; Standard screw-down fittings; Black or Brown .49c ea.
12" Phono Felts; Green or Brown .15c ea.
.00035 3-Circuit Tuners; 2 1/2" x 3" .75c ea.
Western Electric Earphones; 2 M Ohms; inc. headband and cord .24c ea.
Dixie Cannonball Phones; 2 M Ohms; complete .95c ea.
Double Slider Crystal Set Kit .98c ea.
Western Electric Keys; mntd. on Bakelite Bases .49c ea.
Empco Phone Plugs; flat shape .10c ea.
Black Polished Bakelite Tubing; 2 3/4" Lengths; 1/16" Wall .7c ea.
Bakelite Cut to Size; Brown or Black; 3/16"-1 1/4" sq. in.; 1/4"-1c sq. in. .12c ea.
Pie-Wound R.F. Chokes; 2 1/2 Mill.; 4-Section; green silk .12c ea.
N. 18 Push Back Wire; stranded, tinned, black; 100 Ft. Rolls .49c ea.
Micamold Fixed Conds.; most caps. in stock .35c doz.
1/3 Watt Resistors; color coded; pkgge. 25 assorted .15c pkgge.
3 Gang .00035 Conds.; Clockwise; 3" x 2 1/2" x 3 1/2" .39c ea.
High Gain AC-DC Coils; set of 2 .29c set
Light Power AC Motor; 1750 RPM with gear reduction arrangement for 78 RPM; includes mounting bracket, ideal for winding or polishing rig-up, display stands, etc. .89c ea.

Minimum order \$1.00, 20% deposit required

LEOTONE RADIO CO.
63 Dey St., Dept. RC-2, New York, N. Y.
Leading for 20 years as mfrs. of cones and field coils.

Social Security Name Plate



Only 35¢

Bronze Plate with your Name & Number on it

and This **GENUINE LEATHER BILLFOLD** without Extra Charge



For the nominal amount of 35c we will send you the following values:
1. One duo-tone imperishably etched Bronze Name Plate, size 3x1 1/2 inches with your Social Security number and name permanently stamped upon it.
2. One Genuine Leather Billfold, size 8 1/4 x 3 inches in natural brown color, with four compartments, as per illustration above.
This Pocketbook is our free present to you. Absolutely no strings or any kind. We make you this gift because we expect you to do us a favor by showing your name plate to your friends, to interest them in ordering one for themselves. That's all. Help us and you will profit yourself.

ACT NOW! Mail the coupon below and enclose 35c in the form of coins. The bronze name plate and the Leather Billfold will be forwarded to you at once.

PREMIUM DISTRIBUTING SERVICE
Wrigley Bldg., Chicago, Dept. RC-741

Enclosed find 35c for which mail to the address below, my Social Security Bronze Name Plate and the Genuine Leather Billfold without extra cost, as per your offer.

My Social Security Number is

NAME

ADDRESS

CITY STATE

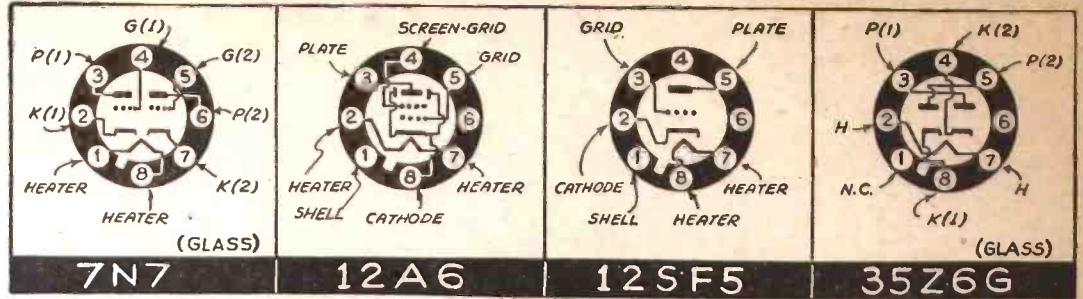

RECEIVING
1LC5 R.F. Amplifier Pentode
The type 1LC5 is an R.F. amplifier pentode in glass bulb, loctal construction, designed especially for service in low-drain, battery-operated receivers as an R.F. or I.F. amplifier when small size and light weight are desired.

The outstanding feature of the type 1LC5 is its ability to function at reduced "B" voltages. This tube can be used satisfactorily in A.V.C. circuits since it has a medium cut-off characteristic. Type 1LC5 is a high-impedance tube and should be worked into a high impedance if maximum R.F. amplification is to be attained. The circuit applications are the same as for the type 1LN5.

For maximum advantages the 1LC5 should be used in conjunction with the other types in the "Reduced Plate Voltage" tube complement, types 1LC6, 1LD5, and 1LB4. Filament: 0.05-A. at 1.4 V.
Characteristics, Table V.—Hygrade *Sylvania*.

1LC6 Pentagrid Converter
This pentagrid converter is a glass loctal type, designed especially for service in low-drain, battery-operated receivers when small size and light weight are desired. Its outstanding feature is its ability to function at reduced "B" voltages.

The circuit applications are the same as for the type 1LA6, but the difference in characteristics and operating conditions must be taken into account to secure optimum performance. Filament: 0.05-A. at 1.4 V.
Characteristics data, Table VI.—Hygrade *Sylvania*.

1LD5 Combined Diode & Audio Pentode
Type 1LD5 is a diode - audio pentode combination designed especially for service in low-drain, battery-operated receivers as a diode detector and pentode audio amplifier, when small size and light weight are desired. This glass loctal tube functions at reduced "B" voltages.

The circuit application is the same as that of the type 1LH4 except that the amplifier section is constructed as a pentode to take advantage of the higher gain at low plate voltage compared with that of a triode. For maximum advantages, the 1LD5 should be used in conjunction with the other types in the "Reduced Plate Voltage" tube complement (the 1LC6, 1LC5, and 1LB4). Filament: 0.05-A. at 1.4 V.
Characteristics data, Table VII.—Hygrade *Sylvania*.

3S4 Battery/Electric Power Amplifier Pentode (Miniature Type)
The 3S4 is intended for use in the output stage of lightweight, A.C./D.C. battery-operated portable equipment. This new tube has essentially the same characteristics as the miniature type 1S4 but is designed with a filament having a center-tap to permit of either a series-filament or a parallel-filament operating arrangement. The series arrangement requiring only 50 milliamperes has been provided especially for equipment utilizing a source of rectified power for the filament supply. May be used in "personal portables."
Characteristics, Table VIII.—RCA.

5W4GT High-Vacuum Full-Wave Rectifier
The 5W4GT high-vacuum full-wave rectifier has a metal bulb, and is designed for use in A.C. receivers having relatively low current requirements. Filament: 1.5-A. at 5 V.
Characteristics data, Table IX.—RCA.

6C5GT Triode Detector or Amplifier
This tube is a triode for use as a general-purpose amplifier or detector. Metal shell. Heater (A.C./D.C.): 0.3-A. at 6.3 V.
Characteristics, Table X.—Raytheon.

6SD7GT Variable-Mu Pentode
This tube bantam-type is a semi-remote cutoff pentode with relatively high transconductance. It is recommended for use as an R.F. and I.F. amplifier. Metal shell. Heater (A.C./D.C.): 0.3-A. at 6.3 V.
Characteristics data, Table XI.—Raytheon.

6U6GT Beam Power Amplifier
The 6U6GT, bantam-size beam power amplifier, is designed to deliver reasonably high output at lower supply voltage than normally required. Glass bulb. Heater (A.C./D.C.): 0.75-A. at 6.3 V.
Characteristics data, Table XII.—Raytheon.

7H7 Semi-Remote Cutoff Pentode Amplifier
7H7 is a high mutual conductance pentode which has been designed to have as wide a cutoff as is consistent with a good ratio of Gm to plate current. This tube has a 2-watt cathode in place of the usual 3-watt cathode used in other high-Gm amplifier tubes and hence may be used in series with other 2-watt cathodes. This new type will find application in untuned R.F. circuits, wide-band, high-frequency amplifiers and other equipment where the high-Gm characteristics are desirable. Glass bulb, loctal base.
Characteristics data, Table XIII.—Raytheon.

7L7 Sharp-Cutoff Pentode
This glass tube, with lock-in base, is a sharp-cutoff pentode with relatively high transconductance for use where the types having higher transconductance are not required.
Characteristics data, Table XIV.—Raytheon.

7N7 Twin-Triode Voltage Amplifier or Phase Inverter
This lock-in base, twin-triode glass tube has separate cathode leads. This construction affords increased circuit versatility.
Characteristics data, Table XV.—Raytheon.

12A6 Beam Power Amplifier
The 12A6 is a beam power amplifier of the metal type with a 12.6 V., 0.15-A. heater for use in A.C./D.C. receivers. With 250 V. on plate and screen-grid, the 12A6 can handle a power output of 2.5 watts with 10% distortion (total). Metal shell.

Typical operating conditions (tentative): plate, 30 ma. (no signal); at 250 V. screen-grid, 3.5 ma.; at 250 V. control-grid, -12.5 V.—RCA.

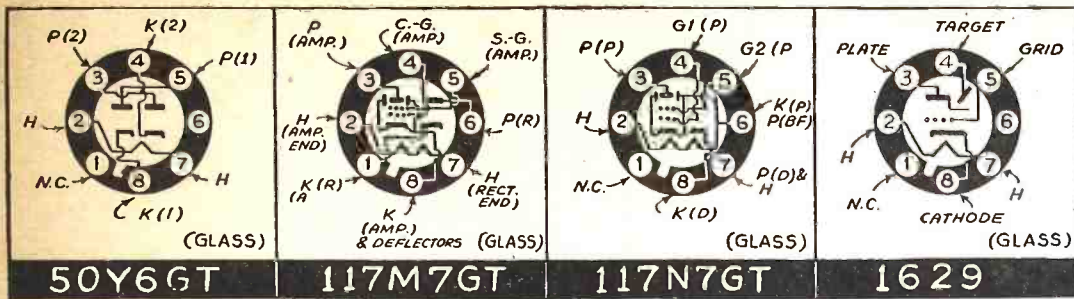

12SF5 High-Mu Triode Amplifier
 This type 12SF5 tube is a metal shell, high-mu triode which is particularly suitable as a resistance-coupled audio frequency amplifier in A.C.-D.C. receivers with series filament connections. Heater: 0.15-A. at 12.6 V. Characteristics, Table XVI.—Raytheon.

35Z6G High-Vacuum, Twin-Diode Rectifier & Voltage Doubler
 The 35Z6G is a twin-diode rectifier designed for use in voltage doubler circuits in A.C.-D.C. receivers. It is characterized by a plate current rating of 110 ma. which is somewhat higher than similar ratings for other voltage doublers such as the 25Z6G. Glass shell. Heater: 0.3-A. at 25 V., A.C./D.C. Characteristics, Table XVII.—Raytheon.

50Y6GT High-Vacuum, Twin-Diode Rectifier & Voltage Doubler
 50Y6GT is a double-diode, heater-type glass-bulb rectifier for use in full-wave or voltage doubler circuits in A.C.-D.C. receivers where the 50-volt heater rating is of advantage. Heater: 0.15-A. at 50 V., A.C./D.C. As a half-wave rectifier, it may be necessary to add filter impedance where filter capacity exceeding 40 mf. is used. Characteristics, Table XVIII.—Raytheon.

117M7GT Combined Rectifier & Beam Power Amplifier
 This tube is a 2-section, high-heater-voltage glass-bulb tube for service as both rectifier and beam power output amplifier in applications where it is desired to connect the heater directly across the 117-volt powerline. Transformer or impedance input coupling devices are recommended. If resistance coupling is used, the D.C. resistance in the grid circuit should not exceed 0.5-megohm with self-bias or 0.1-megohm with fixed-bias. Heater: 0.09-A. at 117 V., A.C./D.C. Same comment applies, regarding use of filter capacity exceeding 40 mf., as for 50Y6GT. Characteristics, Table XIX.—Raytheon.

117N7GT Combined Rectifier & Beam Power Amplifier
 The 117N7GT is a multi-unit tube containing a half-wave rectifier and a beam power amplifier in the same envelope (T-9). It is intended primarily for use in portable battery/A.C./D.C. receivers. The power amplifier unit delivers 1.2 watts with 100 volts on plate and screen-grid. The heater, which draws 0.09-A., is designed for operation directly across a 117-volt A.C./D.C. power-supply line. Glass bulb. Characteristics data, Table XX.—RCA.

1629 Electron-Ray Tube Indicator "Eye"
 The 1629 is a high-vacuum, heater-cathode type of glass-bulb tube designed to indicate visually, by means of a fluorescent target, the effects of a change in the controlling voltage. The tube, therefore, is essentially a voltage indicator and as such is particularly useful as a convenient and non-mechanical means of indicating accurate adjustment of a circuit to the desired conditions. Because of its 12.6-volt (0.15-A.) heater and its 7-pin base, the 1629 is particularly suitable for service in aircraft radio equipment. In this equipment and other

equipment subject to vibration and shock, the 7-pin small octal base provides ample friction to hold the base in its socket. Characteristics data, Table XXI.—RCA.

TABLE I—6AG7
 Average Characteristics

Plate voltage	300	volts
Screen-grid voltage	300	volts
Control-grid bias	-10.5	volts
Plate resistance	0.1	megohm
Transconductance	7,700	mmhos
Plate current	25	ma.
Screen-grid current	6.5	ma.

TABLE II—2X2/879
 Ratings

Heater voltage (A.C.)*	2.5	volts
Heater current	1.75	amp.
Max. A.C. plate voltage (r.m.s.)	4,500	volts
Max. peak inverse voltage	12,500	volts
Max. peak plate current	100	ma.
Max. D.C. output (continuous)	7.5	ma.

*It is important that the heater transformer secondary be insulated to withstand the maximum peak inverse voltage encountered in the installation.

TABLE III—929
 Maximum Ratings and Characteristics

Anode-supply voltage (D.C. or peak A.C.)	250	max. volts
Anode current, Ambient	20	max. microamperes
temperature	100	max. °C.
Sensitivity	45	microamp./lumen
Sensitivity at 3,750 angstroms	0.04	microamp./microwatt
D.C. resistance of load	1	min. megohm

TABLE IV—VR 75/30
 Tentative Ratings

D.C. starting supply voltage (min.)	105	volts
D.C. operating voltage (approx.)	75	volts
D.C. operating current (min.)	5	ma.
D.C. operating current (max.)	30	ma.

TABLE V—1LC5
 Operating Conditions and Characteristics

Plate voltage	45	90	volts
Screen-grid voltage	45	45	volts
Control-grid voltage*	0	0	volt
Plate current	1.1	1.15	ma.
Screen-grid current	.25	.20	ma.
Plate resistance	.7	1.5	meg. (approx.)
Mutual conductance	750	775	mmhos

*A resistance of at least 1 megohm should be in the grid return to negative filament pin No. 8.

TABLE VI—1LC6
 Operating Conditions and Characteristics

Plate voltage	45	90	volts
Screen-grid voltage*	35	35	volts
Anode-grid voltage	45	45	volts
Control-grid voltage (G)†	0	0	volt
Oscillator-grid resistor (G ₀)	200,000	200,000	ohms
Plate resistance	300,000	650,000	megohms
Plate current	0.7	0.75	ma.
Screen-grid current	0.75	0.70	ma.
Anode-grid current	1.4	1.4	ma.
Oscillator-grid current	0.035	0.035	ma.
Total cathode current	2.9	2.9	ma.
Conversion conductance:			
Control-grid voltage at 0 volt	250	275	mmhos
Control-grid voltage at -2 volts	50	50	mmhos
Control-grid voltage at -3 volts	5	5	mmhos (approx.)

*Obtained preferably by using a properly bypassed voltage dropping resistor in series with "B" voltage supply. In order to avoid oscillation difficulties, the screen-grid voltage must be at least 10 volts lower than the oscillator anode.
 †A resistance of at least 1 meg. should be in the grid-return to negative filament, pin No. 8.

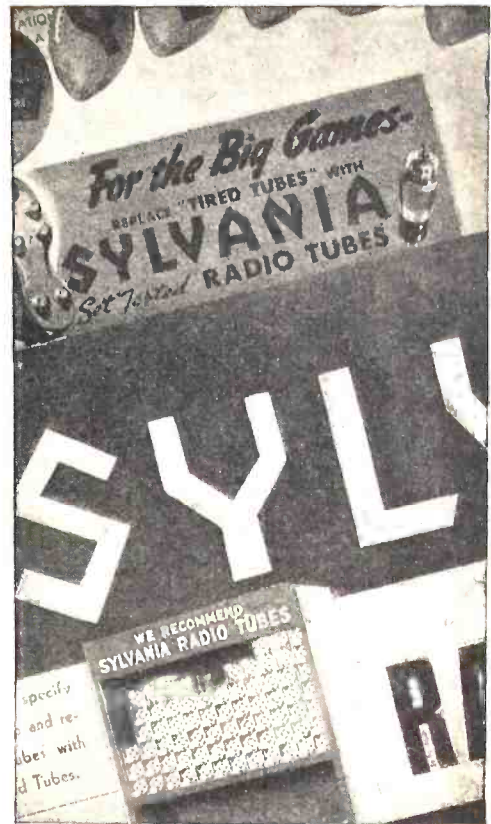

IF YOU attend the National Radio Parts Show in the Hotel Stevens, Chicago, June 10-13, you'll see the Sylvania radio tube line, including the new "Lock-In" tube, on display in the Sylvania booths 18-20. The entire brigade of hot Sylvania business getters, too, will be there for your inspection.

On hand to greet you will be Sylvania factory men who engineer Sylvania Tubes, editors of Sylvania News who interpret technical developments for you, and the men who are creating, planning and producing the sales and advertising material to help you sell.

Don't forget—Sylvania booths 18-20—to your right at the foot of the stairs as you enter the Convention Hall.

Sylvania Radio Tube Division

HYGRADE SYLVANIA CORPORATION

Emporium, Pa. • Salem, Mass. • St. Marys, Pa. • Ipswich, Mass. • Towanda, Pa.

Also makers of Hygrade Lamp Bulbs, Hygrade Fluorescent Lamps and Miralume Fluorescent Light Fixtures



OPPORTUNITY AD-LETS

Advertisements in this section cost 15 cents a word for each insertion. Name, address and initials must be included at the above rate. Cash should accompany all classified advertisements unless placed by an accredited advertising agency. No advertisement for less than ten words accepted. Ten percent discount six issues, twenty percent for twelve issues. Objectionable or misleading advertisements not accepted. Advertisements for August 1941 issue must reach us not later than June 7th.

Radio-Craft • 20 Vesey St. • New York, N. Y.

BOOKS AND MAGAZINES

ASSURE YOURSELF OF GREATER PROFITS BY doing radio service jobs more quickly. Authentic service guides show you the way to locate and correct troubles in any radio receiver. Gernsback Official Radio Service Manuals show you how to complete more repair jobs in less time—how to earn more money by faster servicing. Radcraft Publications, 20 Vesey St., New York City.

WE HAVE A FEW HUNDRED RADIO ENCYCLOPEDIAS, by S. Gernsback, second edition, originally sold at \$3.98. Book has 352 pages, weight 3 lbs., size 9 x 12 inches. Red morocco—keratol flexible binding. Send \$2.49 in stamps, cash or money order and book will be forwarded express collect. Technifax, 1915 So. State Street, Chicago, Illinois.

WHAT DO YOU KNOW ABOUT AMPLIFIERS AND Sound Systems? The Amplifier Handbook and Public Address Guide covers P.A. from A to Z. Most complete and authentic book published on the subject. Contains 80 pages of vital information on Amplifiers, P.A. Systems, Speakers, Accessories, Pickups, Microphones, etc. Printed on fine coated stock, with numerous photographic illustrations and explanatory diagrams, and only 25c. See page 8.

EDUCATIONAL COURSES

CORRESPONDENCE COURSES AND EDUCATIONAL books, slightly used. Sold. Rented. Exchanged. All subjects. Satisfaction guaranteed. Cash paid for used courses. Complete details and bargain catalog FREE. Write Nelson Company, 500 Sherman, Dept. G-242, Chicago.

FLUORESCENT LIGHTING

24" FLUORESCENT BENCH LIGHT \$1.49, LESS TUBE. Harold Davis, Jackson, Mississippi.

PHOTOGRAPHY

1/100,000 OF A SECOND SPEED FLASH UNIT FOR Stroboscopic Photography, \$200.00. Apt. 63, 782 West End Ave., New York City.

PRINTING

100 8 1/2 x 11 Bond Letterheads and 100 6 3/4 Envelopes \$1.00 postpaid. In Hammermill \$1.25. Benvenille Printing, 907 West Roosevelt, Philadelphia, Pa.

RADIO

SACRIFICE! 12-TUBE LINCOLN SUPER-DELUXE All-Wave Receiver, complete with 12-inch electrodynamic speaker and separate power pack. Cost originally \$145. Will sacrifice for \$25.00. Set is 1933 model, rarely used and in good working condition. Excellent sensitivity and selectivity. A resonance tuning meter, wave-band switch, phonograph input terminals, an ideal set for the DX fan. Excellent tonal fidelity. All components mounted on a beautiful chromium-finished chassis. Rush! First come, first served! D. Kreissman, 1430 Ocean Ave., Brooklyn, N. Y.

AT LAST! SUCCESSFUL SYSTEM RADIO TUBE RE-juvenation. One dollar. Warranted. Vance Land, St. Paul, Nebr.

WANTED—ADAMS-MORGAN WOODEN-CASE, BRASS-plate variable condenser; electrolytic detector. Have radio sets, meters, etc.—or what do you want? R. Bernard, 40 Manning Ave., No. Plainfield, N. J.

TECHNICAL ART SERVICE

DRAFTING AND ART SERVICE—A COMPLETE Service for the Industrial and Commercial Marketers. If your business or plant can't afford a designing or drafting staff, don't let this stop you from going ahead with that new product you intend marketing, or that catalog of mechanical or electrical items which needs fine detailed drawings and highly retouched photographs. Any mechanical, electrical or radio problem can be solved for you by our associated staff of designers, draftsmen and artists, and technical copywriters. Write for any additional information as to methods and price for this service. Tec-Art Drafting Service, 228 Charlotte Terrace, Roselle Park, N. J.

DRAFTING SCHEMATIC DIAGRAMS SEND US A rough sketch of your circuit. Estimates by return mail. Our prices are moderate; our work guaranteed. No jobs too big or small. Wm. Kadlecik, Jr., 440 East 85th St., New York, N. Y.

TABLE VII—1LD5

Characteristics			
Plate voltage	45	90	volts
Screen-grid voltage	45	45	volts
Control-grid voltage	0	0	volt
Plate current	0.55	0.6	ma.
Screen current	0.12	0.1	ma.
Plate resistance	900,000	750,000	ohms
Transconductance	550	575	mmhos

Typical Operating Conditions as Resistance-Coupled Amplifier

Plate supply**	40.5	81	volts
Screen-grid supply**	40.5	81	volts
Control-grid voltage	0	0	volt
Load resistor	1	1	megohm
Series screen-grid resistor	5	7	megohms
Screen-grid bypass condenser	0.1	0.1	mmf.
Grid resistor	5	5	megohms
Voltage gain	70	120	approx.

**"B" supply voltage minus power output tube bias.

TABLE VIII—3S4

Tentative Data

Amplifier	Series Filament Arrangement*		Parallel Filament Arrangement*	
Filament voltage (D.C.)†	2.8	1.4	volts	
Filament current	0.05	0.1	amp.	
Plate voltage	67.5 max.	67.5 max.	volts	
Screen voltage	67.5 max.	67.5 max.	volts	
Total cathode current for max. signal	9.5 max.	11 max.	ma.	
Total cathode current for zero signal	7.5 max.	9 max.	ma.	
Typical operation and characteristics—				
Class A ₁ amplifier:				
Plate voltage	67.5	67.5	volts	
Screen-grid voltage	67.5	67.5	volts	
Control-grid voltage*	-7	-7	volts	
Peak A-F grid voltage	7	7	volts	
Zero-signal plate current	6	7.2	ma.	
Zero-signal screen-grid current	1.2	1.5	ma.	
Plate resistance (approx.)	0.1	0.1	meg.	
Transconductance	1,400	1,550	mmhos	
Load resistance	5,000	5,000	ohms	
Total harmonic distortion	12	10	%	
Max.-signal power output	0.160	0.180	watt	

†The filament power drycell-battery supply may be obtained from drycells, from storage cells, or from a power line. With drycell battery supply, the filament may be connected either directly across a cell rated at a terminal potential of 1.5 volts, or in series with the filaments of similar tubes across a power supply consisting of drycells in series. In either case, the voltage drop across each 1.4-volt section of filament should not exceed 1.6 volts. With power-line or storage cell supply, the filament may be operated in series with the filaments of similar tubes. For such operation, design adjustments should be made so that, with tubes of rated characteristics, operating with all electrode voltages applied and on a normal line voltage of 117 volts or on a normal storage-battery voltage of 2 volts per cell (without a charger) or 2.2 volts per cell (with a charger), the voltage drop across each 1.4-volt section of filament will be maintained within a range of 1.25 to 1.4 volts with a nominal center of 1.3 volts. In order to meet the recommended conditions for operating filaments in series from dry cell, storage cell, or power-line sources it may be necessary to use shunting resistors across the individual 1.4-volt sections of filament.

*For series filament arrangement, filament voltage is applied between pins No. 1 and No. 7. The grid voltage is referred to pin No. 1. For parallel filament arrangement, filament voltage is applied between pin No. 5 and pins No. 1 and No. 7 connected together. The grid voltage is referred to pin No. 5.

TABLE IX—5W4GT

Tentative Data

Full-Wave Rectifier	
Peak inverse voltage	1,400 max. volts
Peak plate current per plate	300 max. ma.
With condenser—input filter:	
A.C. plate voltage per plate (r.m.s.)	350 max. volts
Total effective plate-supply impedance per plate†	25 min. ohms
D.C. output current	100 max. ma.
With choke—input filter:	
A.C. plate voltage per plate (r.m.s.)	500 max. volts
Input-choke inductance	6 min. hys
D.C. output current	100 max. ma.

†When a filter-input condenser larger than 40 mf. is used, it may be necessary to use more plate-supply impedance than the minimum value shown to limit the peak current to the rated value.

Horizontal operation permitted if pins 2 and 8 are in a horizontal plane.

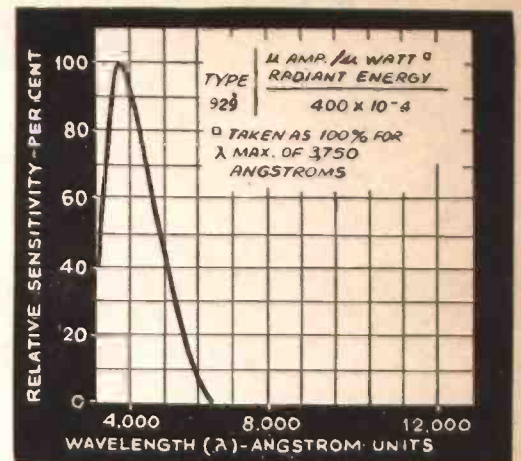

This curve of the spectral sensitivity of the type 929 tube, employing a type S-4 photosurface in a lime-glass bulb, illustrates the sensitivity of this tube to blue light.

TABLE X—6C5GT

Typical Amplifier Operation—Class A ₁	
Heater voltage	6.3 volts
Plate voltage	250 volts
Control-grid bias**	-8 volts
Amplification factor	20
Plate resistance	10,000 ohms
Transconductance	2,000 mmhos
Plate current	8 ma.

Typical detector Operation—

	Biased Type	Gridleak Type	
Heater voltage	6.3	6.3	volts
Plate voltage	250	45 to 100	volts
Grid bias	-17*	0	volts
Grid leak	—	0.1 to 1.0	megohm
Grid condenser	—	50 to 500	mmf.

**The D.C. resistance in the grid circuit should not exceed 1.0 megohm.
*Approximate. Plate current should be adjusted to 0.2-ma. with no signal.

TABLE XI—6SD7GT

Typical Amplifier Operation—Class A ₁			
Heater voltage	6.3	6.3	volts
Plate voltage	100	100	volts
Screen-grid voltage	100	100	volts
Control-grid bias	-2	-2	volts
Suppressor-grid voltage	0	0	volt
Plate resistance (approx.)	0.25	1.0	meg.
Transconductance	3,350	3,600	mmhos
Plate current	5.7	6.0	ma.
Screen-grid current	2.0	1.9	ma.
Control-grid bias for transconductance	-11	-11	volts

TABLE XII—6U6GT

Typical Amplifier Operation—Class A ₁		(Tube may also be used at 200 plate volts)	
Heater voltage	6.3	6.3	volts
Plate voltage	110	135	volts
Screen-grid voltage	110	135	volts
Control-grid bias	-10.5	-13.5	volts
Plate resistance (approx.)	10,000	10,000	ohms
Transconductance	5,600	6,200	mmhos
No-signal plate current	44	55	ma.
No-signal screen-grid current (nominal)	4	5	ma.
Max.-signal peak voltage	10.5	13.5	volts
Max.-signal plate current	47	60	ma.
Max.-signal screen-grid current (nominal)	11	15	ma.
Load resistance	2,000	2,000	ohms
Total harmonic distortion	10	10	%
Power output	2.0	3.3	watts

TABLE XIII—7H7

Typical Amplifier Operation—Class A ₁			
Heater voltage	6.3	6.3	volts
Heater current	0.3	0.3	amp.
Plate voltage	100	250	volts
Screen-grid voltage	100	150	volts
Control-grid bias	-1	-2.5	volts
Suppressor-grid voltage	0	0	volt
Plate resistance (approx.)	0.3	1	meg.
Transconductance	4,000	3,500	mmhos
Plate current	8.5	9.0	ma.
Screen-grid current	3.5	2.5	ma.
Grid bias for 1% of transconductance at operating bias	-12	-19	volts

TABLE XIV—7L7

Typical Amplifier Operation—Class A ₁			
Heater voltage	6.3	6.3	volts
Heater current	0.3	0.3	amp.
Plate voltage	100	250	volts
Screen-grid voltage	100	100	volts
Control-grid bias	-1	-1.5	volts
Cathode bias resistor	125	250	ohms

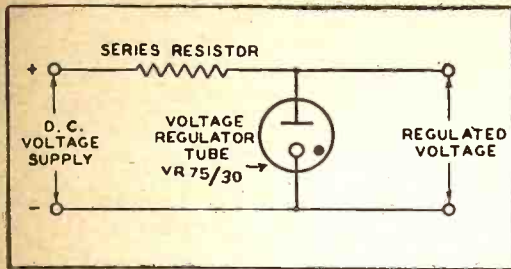

This illustration shows the use of the type VR 75/30 cold-cathode voltage regulator in a theoretical circuit arrangement.

Suppressor-grid voltage	0	0	volts
Plate resistance (approx.)	0.1	1	meg.
Transconductance	3,000	3,100	mmhos
Plate current	5.5	4.5	ma.
Screen-grid current	2.4	1.5	ma.
Grid bias for cathode current cutoff (approx.)	-5	-5	volts

TABLE XV—7N7
Typical Amplifier Operation—Class A₁—Each Triode

Heater voltage	6.3	6.3	volts
Heater current (total)	0.6	0.6	amp.
Plate voltage	90	250	volts
Control-grid bias	0	-8	volts
Amplification factor	20	20	
Plate resistance	6,700	7,700	ohms
Transconductance	3,000	2,600	mmhos
Plate current	10	9	ma.

TABLE XVI—12SF5
Typical Amplifier Operation—Class A₁

Heater voltage	12.6	volts
Plate voltage	250	volts
Control-grid bias*	-2	volts
Amplification factor	100	
Plate resistance	66,000	ohms
Transconductance	1,500	mmhos
Plate current	0.9	ma.

*The D.C. resistance in the grid circuit of the 12SF5 should not exceed 1.0 megohm.

TABLE XVII—35Z6G
Ratings

Max. A.C. voltage per plate (r.m.s.)	235	volts
Max. peak inverse voltage	700	volts
Max. heater-cathode potential	350	volts
Max. steady-state peak plate current per plate	660	ma.
Tube voltage drop (Measured with applied D.C. at 220 ma. per plate.)	20	volts

TABLE XVIII—50Y6GT
Ratings

Max. A.C. voltage per plate (r.m.s.)	235	volts
Max. peak inverse voltage	700	volts
Max. D.C. heater-cathode potential	350	volts
Max. steady-state peak plate current per plate	450	ma.
Tube voltage drop (Measured with applied D.C. at 150 ma. per plate.)	22	volts

TABLE XIX—117M7GT
Ratings

Max. A.C. plate voltage (r.m.s.)	117	volts
Max. D.C. output current	75	ma.

Max. peak inverse voltage	350	volts
Max. steady-state peak plate current	450	ma.
Max. D.C. heater-cathode potential	175	volts
Mini. total effective plate supply impedance†	15	ohms
Voltage drop (Measured with applied D.C. at 150 ma. plate current.)	22	volts

Amplifier Section

Max. plate voltage	110	volts
Max. screen-grid voltage	110	volts
Max. plate dissipation	6	watts
Max. screen-grid dissipation (no-signal)	1	watt

†If filter condensers larger than 40 mf. are used, it may be necessary to add additional plate supply impedance.

TABLE XX—117N7GT

Tentative Data
Rectifier Unit (Half-Wave)

Peak inverse voltage	350	max.*	volts
Peak plate current	450	max.*	ma.
D.C. heater-cathode potential	175	max.*	volts
With condenser-input filter:			
A.C. plate voltage (r.m.s.)	117	max.*	volts
Total effective plate-supply impedance†	15	min.*	ohms
D.C. output current	75	max.	ma.

Amplifier Unit

Plate voltage	117	max.*	volts
Screen-grid voltage	117	max.*	volts
Plate dissipation	5.5	max.*	watts
Screen-grid dissipation	1	max.*	watt

Typical Operation and Characteristics—Class A₁
Amplifier

Plate voltage	100	volts
Screen-grid voltage	100	volts
Control-grid voltage‡	-6	volts
Peak A.F. grid voltage	6	volts
Zero-signal plate current	51	ma.
Zero-signal screen-grid current	5	ma.
Plate resistance (approx.)	16,000	ohms
Transconductance	7,000	mmhos
Load resistance	3,000	ohms
Total harmonic distortion	6	%
Max.-signal power output	1.2	watts

*For 117-volt line.

†When a filter-input condenser larger than 40 mf. is used, it may be necessary to use more plate-supply impedance than the minimum value shown to limit the peak plate current to the rated value.

‡Type of input coupling used should not introduce too much resistance in the grid circuit. When the grid circuit has a resistance not higher than 0.25-megohm, fixed-bias may be used; for higher values, cathode-bias is required. With cathode-bias, the grid circuit may have a resistance as high as, but not greater than 1.0 megohm.

TABLE XXI—162G
Ratings

As Tuning Indicator
Typical Operation

Plate and target supply voltage	100	250	volts
Series triode-plate resistor	0.5	1.0	meg.
Target current†‡	1.0	4	ma.
Triode-plate current†	0.19	0.24	ma.
Triode-grid voltage (approx.):			
For shadow angle of 0°	-3.3	-8	volts
For shadow angle of 90°	0	0	volts

†Subject to wide variation.

‡For triode-grid bias of 0 volts.

In circuits where the heater is not directly connected to the cathode, the potential difference between the heater and the cathode should be kept as low as possible.

SERVICE SPEED-UP TOOL

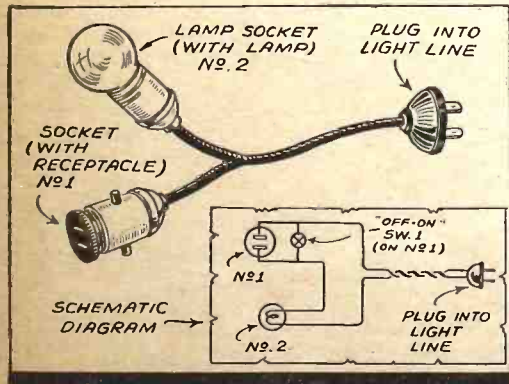

HERE illustrated is a simple device the writer has been using for some time to speed servicing. It is a variation of the well-known fuse-test lamp that consists of merely a lamp equipped with prods which permit the lamp to be connected in shunt to a suspected fuse; the lamp lights if the fuse is open. My variation consists of using 2 sockets instead of 1, together with a male

plug, all being connected in series, as shown in the diagram.

When I am called out on a complaint of total inoperation of a radio set, I first make sure that the power outlet is alive by plugging the device into the wall outlet and snapping the "off-on" switch to "on." This shorts the socket and permits the lamp to light if the light line is delivering power at the outlet.

I then snap the switch to "off" and plug the radio set connection into a screw receptacle in the socket equipped with the switch. If the lamp again lights, it indicates that the power transformer primary (or any device you may care to plug into this receptacle) is not open-circuited.

Accidentally snapping switch Sw.1 to the "on" position will short-out the power transformer primary, etc., but will cause no harm as the lamp merely lights up brighter.

JOSEPH SERRET,
New York City

FREE 180 PAGE CATALOG SEND FOR IT NOW!

EVERYTHING IN RADIO At Lowest Prices!

EVERYONE IN RADIO NEEDS THIS BOOK!

Serviceman, Dealer, P.A. Man, Amateur or Builder, get your ALLIED Catalog now! It's the most complete Radio Catalog out today—your Guide to real savings on everything in Radio!

50 NEW SETS. Real Radio hits—3-Way Personal Portables, phonoradios, home recorders, auto radios, amateur sets, etc.

NEW P.A. Great new Sound Systems—7 to 75 watts—for Rentals, Orchestras, Schools, Churches, etc. New ideas—new applications—new low prices—Time Payments—15-Day Trial, etc.

SERVICEMEN. New Test Equipment—tools and gadgets—more than 15,000 quality replacement parts. Big Special Bargain Section, too! Feature values.

BUILDERS. Count on ALLIED for all the new kits and builders' supplies. You can depend on ALLIED as your Radio Supply Headquarters because ALLIED is the 100% Radio House that's always at your service.

ALLIED RADIO CORP.

833 W. Jackson Blvd., Dept. 2-G-1
Chicago, Illinois

Send me your FREE 1941 Radio Supply Catalog.

Name

Address

City State



FLIGHT THE PICTORIAL FLYING REVIEW

Brings you all the phases of world aviation and aeronautics in a non-technical yet educational manner—exciting articles which catch your breath, yet give you the fundamentals of flying and ALL related subjects.

FLIGHT keeps you abreast of all the major developments as fast as they appear anywhere.

Now, when planes and flying are of vital importance to all, you just can't do without this highly absorbing yet instructive publication. You must be "in the know."

Partial Contents of the July issue:
Wellington—Great R.A.F. Bomber; Aircraft—"Hot" Fighters; Dive-Bombers vs. Warships; "Invisible" Parachutes—by Hugo Gernsback; Junkers 87 Dive-Bomber; Secret of Nazi Bomb-Sight; World's Largest Bomber; Sectional View of Boeing "Stratoliner"; How Planes Protect Convoy!; Nazi Plane Secrets; "Question Box."

attractive three-color cover, numerous illustrations.

15¢ a copy

Send 10c for a Sample Copy.

Subscription price \$1.50 a Year, Canada and foreign \$2.00.

FLIGHT MAGAZINE, 20-R Vesey St., New York, N. Y.

Review Radio Parts

ON MONDAY, JUNE 9, 1941, almost the entire Radio Industry gathered at Chicago's Stevens Hotel for its annual Radio Parts National Trade Show. It ran for 4 solid days, up to and including Friday, the 13th (!).

About 125 radio parts manufacturers displayed their latest developments in radio parts and accessories, public address, test equipment, and ham gear, as well as their regular lines. The entire Exhibition Hall at the hotel was occupied.

Most of the industry's associations, including the Radio Manufacturers' Association, Sales Manager's Club, National Radio Parts Distributors' Association, Radio Servicemen of America, and The Representatives, took advantage of the occasion to hold their annual conventions and meetings.

On Thursday, the 12th, the Radio Service Club of America conducted a special program for its members. Friday, the last day, was "open house" day when Servicemen, amateurs, retailers, and all others interested in radio, were admitted to the Exhibition Hall.

AMPERITE COMPANY—BOOTH 931. A completely new design PG dynamic microphone as well as its complete line of velocity microphones was featured. Kontak microphones with and without volume controls for musical instruments and a complete line of ballast tubes were also shown.

ASTATIC MICROPHONE LABORATORY, INC.—BOOTH 422. On display, in addition to a complete line of crystal and dynamic microphones, were crystal phonograph pickups, crystal and magnetic recording heads, accessories, a new microphone, and 2 new pickups, one of which was a mobile-type unit.

ATLAS SOUND CORP.—BOOTH 503. A "vest-pocket" panorama of the newest P.A. speakers, sound products, and accessories was presented in a display of representative samples from each major line. New, novel, and radically different types of microphone stands were featured as were many original speaker enclosures, and novelty baffles, plus a line of high-powered sound projectors and P.M. driver units for every conceivable sound application. Many types of "specification" speakers for special applications also were exhibited.

AUDIO DEVICES, INC.—BOOTH 5. A complete line of accessories and publications for the recording profession as well as an exhibit showing the progress made in the development of substitutes for the aluminum now used in the manufacture of instantaneous recording blanks. Several new lines of discs in all price ranges were announced to the public for the first time.

BLILEY ELECTRIC CO.—BOOTH 730. The display was built around illustrations of the various steps in the manufacture of quartz crystals. In addition an exhibition of the different types of crystal units which are manufactured by Bliley was presented.

WILLIAM BRAND & CO.—BOOTH 424. On display were electrical and insulation materials, featuring the recently developed "Turbo" varnished oil tubing and saturated sleeving, produced in Brand's new American plant. There were also prominently

displayed representative mica films, condenser films, block mica, and mica segments.

BRUSH DEVELOPMENT CO.—BOOTH 627. Display of Brush crystal sound equipment, including pickups (phonograph, industrial, medical types); record cutters; microphones (sound-cell, diaphragm types); the "Vibromike"; headphones (high-fidelity, general purpose, communication types); and the "Hushatone" pillow speaker.

BURGESS BATTERY CO.—BOOTHS 925 and 927. Homer G. Snoopshaw, the well-known Burgess trade character, was at the Show in person, exhibiting all Burgess Portable Radio Batteries, a complete line of 50 different types. Every interested caller was given a copy of the "Burgess Replacement Guide."

CENTRALAB—BOOTHS 108 and 110. An exceptionally complete display of volume controls, selector switches, fixed resistors, ceramic fixed condensers and ceramic trimmers was shown at this company's booth.

CONTINENTAL ELECTRIC CO.—BOOTH 301. A full display of photo tubes, rectifier tubes, rectifier bulbs, electric-fence tubes and vacuum gauges was shown. In addition, there was an interesting display of special tubes developed for unusual electronic applications. Of particular interest were practical demonstrations, using various types of electronic tubes, such as talking over a lightbeam, the operation of burglar alarms, counters, sorters, rectifier applications and others.

DEJUR AMSCO CORP.—BOOTH 1011. A complete line of precision electrical instruments with features of dependability, accuracy and styling was displayed. Also shown was a complete line of Luxtron Photocells of the barrier layer, self-generating types, mounted and unmounted, in various sizes and shapes. A completely new line of DeJur-Amsco electrical and industrial, low- and high-watt rheostats, and potentiometers were on display; also, DeJur-Amsco indus-

trial foot switches. Of interest to the visitors was a colorimeter utilizing DeJur-Amsco components throughout.

BUD RADIO, INC.—BOOTHS 715 and 717. Among the features in this display were a new electron-coupled oscillator for amateur frequency control, a new series of midget condensers and a new type of sheet-metal cabinet construction. In addition, there were transmitting and receiving type variable and fixed air-dielectric condensers; bandswitching and plug-in transmitting coils; transmitter kits; chassis, racks, cabinets and panels; and other shortwave component parts.

CONTINENTAL CARBON, INC.—BOOTH 218. Complete line of carbon and wire-wound resistors, paper dielectric condensers, suppressors, and "Filternoys" for eliminating radio interference.

ELECTRO-VOICE—BOOTH 1019. This company featured their entire line of dynamic, velocity and communication carbon microphones, stands and the new Cardak poly-directional microphone.

GENERAL TRANSFORMER CORP.—BOOTH 414. The new model "C" Porta-Power which supplies 1½ V. "A" and 90 V. "B" power from a 6 V. battery source was shown for the first time. In addition, a complete line of GTC Porta-Power units was displayed.

THE HALLICRAFTERS—BOOTH 711. A complete line of communications equipment including receivers, transmitters, Marine Radiophones and radio direction finders.

HOWARD RADIO CO.—BOOTHS 409 and 411. Complete line of amateur radios, accessories and recording discs. At a special showing in other quarters of the building the Howard replacement chassis was displayed, as were recorders, and a 14-tube F.M. receiver. For many Servicemen and Servicemen-dealers this was the first opportunity to hear F.M.

National Trade Show

HYTRON CORP.—BOOTH 104. A complete line of radio tubes and exact-duplicate ballast tubes. On display also were miniature hearing-aid tubes, all types of radio receiving tubes and transmitting types including some brand-new high-frequency tubes.

INTERNATIONAL RESISTANCE CO.—BOOTHS 1021-1023. A line of fixed and variable resistors, including many special sizes and types was displayed. Particular emphasis was placed on the standard items jobbers should handle for industrial and National Defense requirements.

JENSEN RADIO MFG. CO.—BOOTHS 624 and 626. Displayed for the first time was the new Jensen HYPEX projectors, types UH-20 and UH-24 and Annular Driver Unit Type U-20 which, they claim, represent the greatest advance in projector design since the introduction of the original exponential horn. Likewise displayed for the first time were the new family of Jensen Coaxial high-fidelity speakers incorporating high-frequency range control (variable fidelity). The exhibit also included the new Speech-Master as well as the complete line of Jensen speakers, bass-reflex enclosures and reproducers.

KAINER & CO.—BOOTH 429. Outstanding attraction was the exhibit of the new RT-21 and RT-25 Kainer Re-entrant Trumpets for driver units as well as the improved line of Kainer Sound Projectors.

P. R. MALLORY & CO., INC.—BOOTHS 821 and 823. Of principal interest were the completely new Mallory replacement volume controls. In addition, the company's complete line of condensers, vibrators, Vibrapacks, switches, rheostats, potentiometers, dry-disc rectifiers, battery chargers, grid bias-cells, jacks, plugs, and other items of radio hardware.

JAMES MILLEN MFG. CO., INC.—BOOTH 630. Complete line of radio communication products, newly designed for minimum ease of construction, as well as components such as variable condensers, dials, sockets, inductors, power supplies, etc.

MILLION RADIO & TELEVISION CO.—BOOTH 433. Complete line of signal generators, Micro-Volters and other test instruments as well as sound equipment.

OHMITE MFG. CO.—BOOTH 929. On display was a complete series of vitreous enameled rheostats and resistors, power-type tap switches, radio-frequency plate and power-line chokes, attenuators and other items. A turntable displayed the units to good advantage in front of a background of photo murals which showed manufacturing operations.

OPERADIO MFG. CO.—BOOTH 830. This display featured industrial sound ap-

plications. Flexifone intercommunication and paging systems, portable and fixed sound systems, public address and radio replacement speakers, high-quality custom-built sound equipment for all requirements.

PARK METALWARE CO., INC.—BOOTH 618. An entirely new display showing the complete line of Xcelite tools, many of which were specially made up for the Radio Industry. This exhibit included screwdrivers in 62 different sizes, nut-drivers in 34 different sizes, pliers, etc. Of particular interest was an entirely new line of nut-drivers made from a new plastic which is practically fireproof. The handles of these nut-drivers are of different colors, which enables the user to select the proper sizes at a glance.

PERMO PRODUCTS CORP.—BOOTH 407. Complete line of long-life playback and recording needles. Fidelitone floating point, de luxe Fidelitone long-life needle, Fidelitone home-recording stylus, Permo point recording stylus, transcrip-tone Permo point and micro-specter. Micro-matched points for home recording were featured.

PRESTO RECORDING CORP.—BOOTHS 430 and 432. Several new developments were exhibited in recording equipment and discs, the most important of which was the new K-8 portable recorder weighing 46 lbs. which makes and reproduces high-quality 15-minute transcriptions. Also shown were new lines of glass and metal-base discs for professional and home recording and the Presto Synchro-Sound system for synchronizing disc recordings with 8 mm. and 16 mm. motion pictures. All this was in addition to the standard line of professional recording equipment for broadcasting station and studio use.

QUAM NICHOLS CO.—BOOTH 216. Of special interest to all jobbers was the new Quam Speaker Catalog No. 61, distributed for the first time. It illustrates and describes the complete Quam Replacement Speaker Line. A representative display of Quam Replacement Speakers was exhibited, including the new developments in the Quam Permanic Speakers.

RADIO CITY PRODUCTS CO.—BOOTH 1012. A total of 49 different models of test equipment was displayed. The outstanding instrument was the new Model 661 electronic Multitester which combines a vacuum-tube voltmeter for both A.C. and D.C. measurements, a vacuum-tube ohmmeter for resistance measurements up to 1 billion ohms, and a vacuum-tube capacity meter for measurements as low as 30 mmf. and as high as 1,000 mf. The new 1941-1942 catalog No. 125, listing over 50 models of test equipment, was distributed.

READRITE METER WORKS—BOOTH 725. Theme of this exhibit dealt with the design, manufacture and application of radio test equipment. Readrite's

complete line of meters also was on display.

RECORDING CORP.—BOOTH 1015. A complete line of semi-professional and amateur recording blanks was exhibited. These comprised both the slow-burning and cellulose-nitrate grades, on the 3 most popular bases (aluminum, steel and paper composition). Both cutting and playback needles in various grades, as well as mailing envelopes and miscellaneous accessories, were included.

THE ROLA COMPANY, INC.—BOOTH 910. Featured was the standard models of both dynamic and permanent magnet speakers, as well as the new elliptical type which was about the only outstanding change for 1941.

WALTER L. SCHOTT—BOOTH 426. Besides their complete line of radio chemicals, refinishing kits and other helpful items for the Serviceman, this company featured their new dial belt—which is adjustable and comes open; also their improved staple driver for stapling of intercommunication, P.A., and similar wires. Of special interest to the jobbers were the displays that WALSCO furnished free and which are available for the showing of bottles, tubes, dial cables, etc.

SHURE BROS.—BOOTHS 212-214. This display dramatized the importance of the Shure cardioid microphones in overcoming feedback and solving acoustic problems. The new Shure "Stratoliner" crystal and dynamic microphones also were featured as well as a new low-pressure, high-voltage phonograph pickup. The feedback problem was portrayed by a character described as the "Feedback Fiend."

SOLAR MFG. CORP.—BOOTH 115. As a merchandising aid to the trade, the Solar booth featured an ideal jobbers' display and storage section for condensers and condenser analyzers. All latest Solar products were featured in a most practical and helpful manner. Condenser analyzers were demonstrated under actual working conditions.

SPRAGUE PRODUCTS CO.—BOOTHS 921 and 923. A complete line of Koolohm insulated wire-wound resistors was featured, together with dry electrolytic, wet electrolytic, paper, mica and oil condensers. New uses for Sprague test equipment were displayed.

SUPREME INSTRUMENTS CORP.—BOOTHS 825 and 827. The improved, complete line of Supreme instruments was on display, as well as several new industrial designs this firm is producing on special order.

THORDARSON ELECTRIC MFG. CO.—BOOTHS 920 and 922. Show-goers found a prominent display here of transformers for replacement, amateur, broadcast and commercial use. Of special interest was the advanced showing of new Thor-

THE FINEST RADIO BOOK FREE WE EVER OFFERED :- the 1940-41 Radio-Television Reference Annual With \$1.00 subscription to RADIO - CRAFT

WITH our compliments, we want to send a copy of the 1940 RADIO-TELEVISION REFERENCE ANNUAL to you FREE, if you will simply take advantage of RADIO-CRAFT magazine's special subscription offer NOW. This offer is being made for a limited time only.

The 1940 RADIO-TELEVISION REFERENCE ANNUAL has 68 pages, large size 8½ x 11½, with over 170 illustrations. The contents of this book has never appeared before in handy book form. Its pages cover practically every branch of radio sound, public address, servicing, television, construction articles for advanced radio men and technicians, time and money-saving kinks, wrinkles, useful circuit information, "ham" transmitters and receivers, and a host of other data.

The Annuals have always been regarded as a standard reference work for every practical branch of radio operation and service. This 1940 edition ably sustains this reputation. Every radio man wants a copy of this valuable book. Just as this book will be of unquestionable value to you, so, too, will every monthly issue of RADIO-CRAFT. This magazine brings you big value every month. It keeps you intelligently informed about new developments in radio and television. You want the news, want it fully but concisely, want it first—that is why you should read RADIO-CRAFT regularly.

This very special offer is made for just one purpose—we want you as a regular subscriber. The Annual, whose contents appears at the right, is not sold, but a copy is FREE to you if you subscribe now.

**SAME SIZE AS
RADIO-CRAFT**

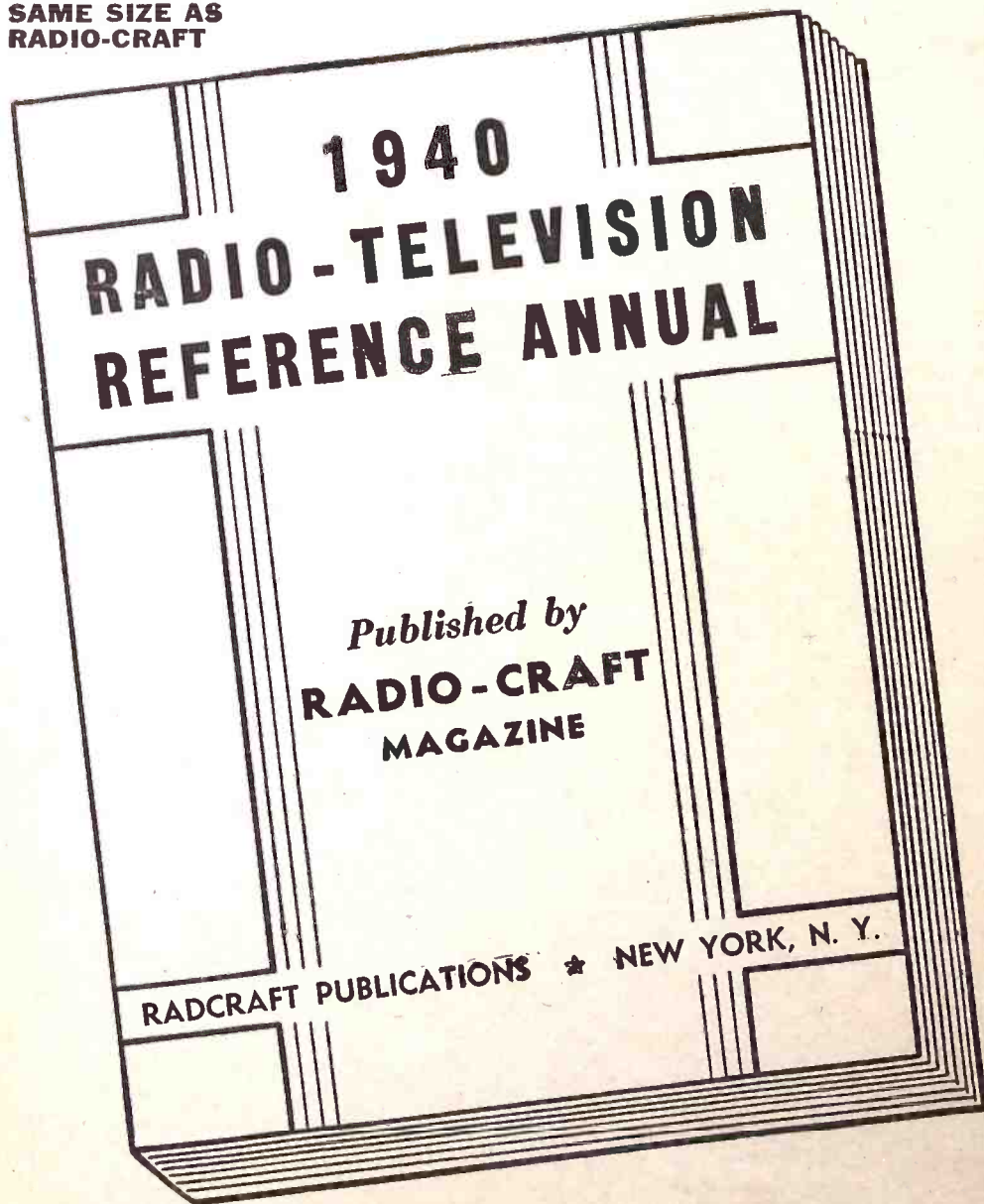

THIS COUPON BRINGS YOU THE ANNUAL

RADIO-CRAFT • 20 VESEY STREET • NEW YORK, N. Y.

Gentlemen: Enclosed you will find One Dollar for which enter my subscription to RADIO-CRAFT Magazine for Eight Months. Send me ABSOLUTELY FREE and POSTPAID, my copy of 1940 RADIO-TELEVISION REFERENCE ANNUAL.

This is a new order Extend My Present Subscription

NAME ADDRESS

CITY STATE

DON'T DELAY — MAIL TODAY! RC-741

**Read the summary of contents
in this FREE BOOK!**

THE 1940 RADIO-TELEVISION REFERENCE ANNUAL contains a collection of the best and most important articles. Covering as they do nearly every branch of radio, they form a handy reference works. In addition, many time and labor-saving kinks, circuits and wrinkles, tried and tested by practicing Servicemen, experimenters and radio fans have been included. This book cannot be bought anywhere at any price. Yet it is yours by merely subscribing. Use the convenient coupon below.

**BEGINNER'S SIMPLE INEXPENSIVE
CONSTRUCTION ARTICLES**

Beginner's Broadboard Special - a 1-Tube High-Gain All-Wave Receiver—Wiring Pointers for Radio Beginners—A Watch Charm Size 1-Tube Set—Beginner's Simple Volt-Milliammeter—Making a 1-Tube Broadcast Loop Receiver—A.C.-D.C. Power Supply for Battery Portables—A 1-Tube Short-Waver with Band Coll Switching.

MORE ADVANCED SET CONSTRUCTION

The "High-Seas 4" Broadcast Lamp Radio—How to Build a 6-Tube 1.4-Volt Short-Wave Superhet for the "Ham" or Short-Wave Fan—Build the "Lunch Box 5" Super Set - a Broadcast Battery Portable—How to Build a Plug-Together 8 Tube Broadcast Set—The "5-in-4" All-Wave Radio for A.C. Operation—An Easily-Built 3-Tube Midget Broadcast Superheterodyne Receiver.

THE SERVICEMEN'S SECTION

Bass Tone Control—Simplified Variable Selectivity—Practical Servicing Pointers—Servicing Universal A.C.-D.C. Receivers—Killing the "Intermittent" Bug—A Service Shop A.C. to D.C. Power Supply—Sideline Money for Servicemen—Adding A.V.C. to any Screen-Grid T.R.F. Receiver—Iron Particles in Speaker Air Gap.

TEST INSTRUMENTS

A Useful Neon Lamp Tester—An Inexpensive Output Meter—Making Milliammeter Multipliers—Home-Made Frequency Modulator—The Busy Servicemen's V.M. Volt-Meter.

PUBLIC ADDRESS AND AMPLIFIERS

Build this Combination A.C.-D.C. Radio and Inter-Communicator—Speaker Placement in P.A. Work—The Design and Construction of an Inexpensive All-Push-Pull 10-Watt Amplifier—Obscure Sources of Hum in High-Gain Amplifiers—How to Build a High-Fidelity 5-Watt Versatile Amplifier.

"HAM" SECTION

Ultra-High Frequency Antennas—The Beginner's Low-Cost Xmitter—Modulator Meter—Phone Monitor—The Beginner's "Ham" Receiver—2½ Meter Acorn Transceiver.

TELEVISION

How to Build a 441 Line T.R.F. Television Receiver—Useful Notes on Television Antennas.

MISCELLANEOUS

Simple Photo-Cell Relay Set Up—Making a Burglar Alarm—How to Build A.C.-D.C. Capacity Relay—How to Make a Modern Radio Treasure Locator.

USEFUL KINKS, CIRCUITS AND WRINKLES

Making a Flexible Coupler—Two-Timing Chime—A Simple Portable Aerial—An Improvised Non-Slip Screw-Driver. NOTE: The book contains numerous other useful Kinks, Circuits and Wrinkles, not listed here.

(approximately)

45 ARTICLES

(approximately)

170 ILLUSTRATIONS

68 BIG PAGES

**RADIO-CRAFT
20 VESEY STREET
NEW YORK, N. Y.**

darson amplifiers covering every amplifier requirement.

THE TURNER CO.—BOOTH 1029 and 1031. In addition to the regular line of Turner microphones and equipment, 2 new model microphones in a higher price bracket were introduced. Also, the new Turner "Push-Pull" Vibrator, a new product this year, was shown with a demonstration of how the "push-pull" feature worked and why it gives better operation.

VACO PRODUCTS CO.—BOOTH 1014. In addition to a most complete line of Amberyl shock- and break-proof plastic handle screwdrivers, a number of new and interesting service tools were shown. Among them were 2 new Amberyl-handle socket wrenches to fit electrolytic-condenser nuts, a new display unit of insulated-blade screwdrivers, a new all-Amberyl-insulated pocket-style Spin-Hex in the popular ¼-in. size, a new all-Amberyl-insulated trimmer screwdriver, and a clever new radio service socket wrench set.

VULCAN ELECTRIC CO.—BOOTH 425. Included in this display was a complete line of electric soldering irons, precision-made for production work. Of exceptional interest to those having production soldering to do was the long-life Vulcan "Durever" tips that are available for all sizes of Vulcan tools. Featured also was their line of melting pots for solder, tin, and lead; and others for the melting of waxes and compounds as well as a complete assortment of automatic glue-pots.

WARD LEONARD ELECTRIC CO.—BOOTH 109. The display consisted of various types of Vitrohm resistors showing the new green enamel and the stages of its manufacture. Attention was directed to improvements in many of the relays on display which included the first radio exhibition of the Little Giant Relay.

WEBSTER-CHICAGO CORP.—BOOTHS 112-114. An interesting item exhibited at the Show was their 2 portable recorders. Another highlight at the exhibit was a brand new single-speed portable recorder.

WEBSTER ELECTRIC CO.—BOOTH 317. A complete line of crystal and magnetic phonograph reproducer pickups and pickup cartridges and recorder heads which incorporated many new design features were shown. The complete line of sound equipment was also on display.

WIRT COMPANY—BOOTH 416. On display was their line of rotary and snap switches and auto-radio ignition suppressors, including 2 new items; carbon composition and wire-wound resistors, both fixed and variable; also wire-wound volume controls and potentiometers.

WORNER PRODUCTS CORP.—BOOTH 435. Of particular interest were the displays of photoelectric equipment and their applications to the industries. These

displays illustrated protection of property against burglary and sabotage; life and limb protection against hazards in production; the registering of smoke to less than 5% change in light density; and, their standard packaged goods line which can be called upon to meet the average requirements of the industry.

AMERICAN MICROPHONE CO. Aside from their regular line of microphones, microphone stands, and accessories, there were displayed 2 entirely new mikes, viz.: a new crystal unit having what is claimed to be a more efficient coupling system between the diaphragm and crystal element; and a new dynamic microphone in which 2 units are used, providing, it is claimed, an overall range from 25 to above 10,000 c.p.s.

THE HAMMARLUND MFG. CO.—BOOTH 924. This exhibit included models of the latest communications receivers for engineer, amateur and shortwave listener. Also a complete line of variable air condensers, sockets and coils for commercial and amateur use.

MEISSNER MFG. CO.—BOOTHS 614 and 616. An entirely new and extremely modern display arrangement was used by Meissner to present the feature items of their growing line of receivers, test instruments, Amateur equipment and Service parts. Special attention was given to the new F.M. Receivers and Converters as well as to what is claimed to be the very latest and most complete Phono-Recorder on the market.

NATIONAL CARBON CO., INC.—BOOTHS 727 and 729. This company had a display of their complete line of Eveready radio batteries featuring the Eveready "Mini-Max" style of "B" battery for portable sets.

STANDARD TRANSFORMER CORP.—BOOTHS 117 and 119. Aside from the display of their complete line of equipment, including power packs for P.A. work and pinball machines, audio amplifier components of all types, amplifier foundation kits, ballasts for the new fluorescent lights, etc., a number of very interesting catalogs were available free of charge. These included a power pack catalog listing auto-radio demonstration packs and replacement units for pinball games; a 41-page Service Guide showing replacement power transformers for well over 5,000 radio sets; a general catalog covering their entire line of packs, kits, transformers, chokes, etc.; and the well-known Hammanual which in addition to the usual line of amplifier kits, introduced 2 entirely new kits which should be of interest to all P.A. specialists.

WILCOX-GAY CORP.—BOOTH 6. A low-priced, perfected, dual-speed, straight recorder in portable carrying case was featured. Also shown was the popular Recordio Pro incorporating dual-speed, 10 tubes, 2 turntables. Red Label high-fidelity genuine Recordio metal discs in free album, cutting styli, playback needles, and recording accessories also were on display.

RADIO & TELEVISION—JULY 1941 ISSUE

A Beat Oscillator for the "Ham Beginner," by L. M. Dezettel
 A High-Fidelity Audio Amplifier, by Larry LeKashman, W2IOP
 An End-Fed "Zepp" for Receiving, by Rod Newkirk, W9BRD
 Latest Television News
 An Emergency Short-Wave Transmitter and Receiver, by L. B. Robbins

The T.R.F.-7, by Stanley Weber
 The International Radio Review
 A Four-Tube Tuned Radio Frequency Receiver, by Ralph W. Martin
 Audio System and Modulator for FM Ham Transmitter, by Ricardo Muniz, E.E., Donald Oestreicher, Warren Oestreicher
 "CQ"—News of the Hams, by W2IOP



A new HOTEL
 AWAITS YOU
 in New York

This world famous establishment, formerly the American Woman's Club, is now one of New York's newest and finest hotels. Its unique facilities include six lounges, five sun-decks, music studios, library, art gallery and three popular priced restaurants. Many floors are reserved exclusively for women.

*
1200 Rooms with Bath
 DAILY—Single, from \$2.50;
 Double, from \$3.50
 WEEKLY—Single, from \$12;
 Double, from \$16

Special Floors and Rates for Students



John Paul Stack
 General Manager

Henry Hudson
 HOTEL

353 WEST 57th STREET * NEW YORK

GEOPHYSICAL PROSPECTING PRINTS

50¢ EACH
7 FOR \$3.—



With any one of the modern geophysical methods described, instruments can be constructed to locate metal and ore veins, subterranean water and oil deposits, buried pipes, tools, or other metallic objects sunken in water, etc. Folder contains blueprints and detailed data covering each instrument.

- Folder No. 1. Radioflexor Pilot. Construction and use of 2 tube transmitter and 3 tube receiver. Reflected wave principle. Visual and aural signals.
- Folder No. 2. Harmonic Frequency Locator. Radiates low frequency wave to receiver. Aural signals.
- Folder No. 3. Beat Note Indicator. 2 oscillators. Visual and aural signals.
- Folder No. 4. Radio Balance Surveyor. Balanced loop principle. Modulated transmitter. Visual and aural signals.
- Folder No. 5. Variable Inductance Monitor. Inductance principle. Aural signals.
- Folder No. 6. Hughes Inductance Balance Explorer. Bridge principle. Aural signals.
- Folder No. 7. Radiodyne Prospector. Balanced loop principle. Very large field of penetration. Aural signals.

Each set of blueprints and instructions enclosed in heavy envelope (9½" x 12½"). Blueprints 22" x 34"; eight-page illustrated 8½" x 11" folder of instructions and construction data **50c**
 Add 5c for postage

The complete set of seven folders **\$3.00**
 Shipping weight 2 lbs. (add 25c for shipping anywhere in U.S.A.)

TECHNIFAX

RC-741
 1917 S. STATE ST. CHICAGO, ILL.

New York Post
 NEW YORK WEDNESDAY MARCH 12 1941

**R. Speeds City's Defense Training Plan
 A Failure; 6 Months Wasted**

By MAUREEN McKEERNAN

Several weeks ago The Post was told by a worried industrialist that the New York defense training program was a failure—that it was not producing the trained men and women needed by factories working on defense contracts. That seemed impossible in view of the ambitious program begun eight months ago.

The government provided some \$2,800,000 for that program, \$1,000,000 for the Board of Education and \$1,800,000 for the National Youth Administration.

The full facilities of the Board of Education's 24 trade schools were made available to men of all ages who wanted to prepare for defense jobs.

The NYA's program was even more ambitious. Involving, among other things, the operation of a shipyard on Staten Island.

However, an investigation of the situation as of today revealed that the worried industrialist was tragically right. The

Continued on Page 6, Col. 4

BOARD OF EDUCATION
 OF THE CITY OF NEW YORK

EMERGENCY TRAINING PROGRAM FOR NATIONAL DEFENSE

THIS CERTIFICATE IS AWARDED TO
John Doe

WHO HAS SATISFACTORILY COMPLETED 400 HOURS
 OF A COURSE IN
RADIO COMMUNICATIONS AND SERVICING

FROM July 15, 1940 TO Jan. 16, 1941

James M. McNeill
 PRESIDENT BOARD OF EDUCATION

William E. Brady
 ASSOCIATE SUPERINTENDENT

For E. O'Leary
 TEACHER IN CHARGE

OUR AILING RADIO DEFENSE PROGRAM

In the following article, the author analyzes the present status of enrollees for the radio training courses being given throughout the country and intended to make available in the shortest possible time, men who are properly trained to the entrance requirements in all the radio fields. This article raises the question, "What definite need is there, if any, for the present so-called Radio Defense Program?" and, "What are the actual technical requirements for radio men to fill this need?"

LEO FENWAY

A YEAR ago if a radio worker heard some one say, "I'm a trainee at the Defense School,"—he envied him.

Today, likely as not, the same trainee is hitting the road, side by side with the untutored mechanic, looking for a job. A boss. Working hours. Pay checks!

The mental processes of both men have been definitely conditioned by the way the Radio Defense Program has bogged down under the weight of its own abstruse activity.

In the interim, in building a National Defense a nation needs something of everything. Every last secret of science, physics, chemistry, metallurgy, mathematics, engineering, plus every last ounce of trained man-power must be ready so that with characteristic speed the wheels of industry can begin producing the Nation's Defense Program needs.

And the wheels are grinding. Defense prosperity is reflected in smiling faces of workers now hustling to build aeroplanes, destroyers, submarines, tanks, nitrates, tools, etc.—in some places factories are working 24 hours a day—while radio technician, Serviceman, and general factory worker stands idly by, bewildered and aghast at the way he's been left holding the bag.

BIG FIRMS HOG DEFENSE JOBS

The Army and Navy need new transmitting and receiving equipment. Contracts amounting to \$38,786,982.10 have already been awarded. The Federal Communications Commission, with an allocation of \$1,600,000 and a supplementary appropriation of \$175,000 has placed orders—and augmented its force by 850 additional technicians.

Referring to the Army and Navy contracts, Philip Murray, president of the C.I.O., charged before 5,000 school superintendents gathered in Atlantic City recently that "the rankest kind of discrimination" was being exercised by the Army, Navy and Defense Commission in awarding defense contracts. He told the American Association of School Administrators that large corpora-

tions were "grabbing most of the defense contracts." He remarked that there were 12,000 plants in the United States capable of producing defense goods, including radio equipment, but that, when he checked-up, "only 30% of them were enjoying the benefit of government contracts."

Small manufacturers of component parts say that not since the day station KDKA uttered the birth-ery of a new industry has radio small-fry received such a set-back.

The expanding Defense industries will soon need some 568,000 new workers,* in 16 occupations except Radio. Any wonder that radio men in general are frantic, because their calling, or trade, or profession, like ASCAP music, has been side-tracked?

UNCLE SAM CALLING CQ?

Deep in his heart, every radio man knows that one laconic invitation from a manufacturer of defense radio equipment for workers to "report, ready for work," would fill his plant with so many men that it would have the appearance of an Invading Army. And where would these men come from? From a hundred and one places where they have found jobs: from machine

*Look Magazine, March 25, 1941.

shops, aircraft factories, shipbuilding plants, from the WPA, from everywhere. Why would they give up their present job, if any, to engage in radio work? Because, radio is like the sea. Once it gets into the blood, it's there to stay.

"But," you say, "Uncle Sam is taking care of the radio worker. What about the Emergency Training Program for National Defense?"

Let's listen-in on 3 men sitting at a bar in a Manhattan tavern. Their topic of conversation is industry's No. 1 job, National Defense. More pointedly, *National Radio Defense*.

These men have many things in common: they are radio technicians; all have certificates from a National Defense School; all are American citizens; all are out of a job.

The big fellow on the right was a W.P.A. mechanic—if something doesn't break soon, he'll go back to the project—who matriculated from the Department of Highways. His nearest companion entered radio during the "neutrodyne" years, when the industry was bursting with vitality. The youngest member of the trio, he's still in his early 20s, was admitted to the school through the State Department of Labor, in the hope that he

This composite ad illustrates a condition which is representative of the 3 months' period up to the time the accompanying article was submitted to *Radio-Craft* and discloses that employers apparently have no urgent need of radio men; even the ad for engineers may be considered an isolated instance, and other occasional ads for radio technicians are lost in column after column of ads for trained personnel in other industries now fulfilling Defense contracts.

<p>Help Wanted—Men Industrial Positions Offered</p> <p>Automatic Screw Machines Excello Boring Machines Internal-External Grinders Engine-Turret Lathes</p> <p>EXPERIENCED OPERATORS TO SET UP ABOVE MACHINES. ALSO</p> <p>TOOL DESIGNER Instrument-Optical Me.</p> <p>AMERICAN CITIZENS ONLY WRITE OR CALL IN PERSON Interviews Mon. to Sat. 9 A. M. to 4 P. M. Tuesdays & Thursdays 10 P. M.</p> <p>AVIATION SHEET METAL FORMING RIVETING AND ASSEMBLY</p> <p>Machine Shop Practice INCLUDING TURNING LATHES, LATHES, MILLING MACHINES, ETC.</p> <p>ELECTRIC WELDING</p> <p>INDUSTRIAL & PRODUCTION BLUEPRINT READING</p> <p>TURRET LATHE OPERATORS</p>	<p>Help Wanted Male—Agencies</p> <p>DESIGNERS</p> <p>EXPERIENCED MECHANICAL DESIGNERS OR SIMILAR POSITIONS</p> <p>RADIO ENGINEER FOR AIRCRAFT RADIO</p> <p>Must be graduates of an engineering college and actual experience</p> <p>INTERVIEWS SAT. (MARCH 1ST) ONLY 9:30 A.M. TO 4:30 P.M. WE WRITE FOR APPLICATION BLANK</p> <p>SPERRY LABORATORY STEWART AND CLINTON AVES. GARDEN CITY, L. I., N. Y.</p>	<p>Help Wanted—Male</p> <p>Technical—Industrial</p> <p>INSTRUMENT MECHANICS</p> <p>Must have experience in assembly and repair of Aircraft Navigational and Control Instruments. Toolmaking background helpful. American citizens.</p> <p>Write Daily or call Monday to Saturday, 9 to 5, Tuesday and Thursday in P. M.</p> <p>ECLIPSE AVIATION BENDIX (TETERBORO), N. J.</p> <p>WELDER—Manufacture located in Providence, R. I., wants experienced plain high-class white metal costume jewelry maker work all year; state experience. Price, salary expected. 2 208 Times Ave.</p> <p>Machine Designer</p> <p>Specialized on grinding equipment Experience and salary required Salary: permanent position, location Detroit. 2 2134 Times Annex.</p> <p>MACHINISTS</p> <p>Man for night shift on automatic lathe. Machine and mental work.</p> <p>FIRST CLASS MACHINISTS</p> <p>Capable of repairing all types machines AUTO. MACHINING</p> <p>Machine operator experienced and only. 4444</p> <p>UNIVERSAL TOOL GRINDER</p>
---	---	--

SUPER SPECIALS

would land a job as a monitoring operator, or some similar position. (Radio Monitoring Officer, examination No. 91, salary \$3,200 a year. Application: available at any Federal Building, General Post Office, or from United States Civil Service Commission, Washington, D.C.)

As they smoke and talk, it is self-evident what each man is thinking: "Where do I go from here?" Just as other radio men all over the country, men whose work helped to make possible a great industry, are trying to get a clearer idea of why they are where they are, and of what they may best do about it.

The W.P.A. man laid his "certificate" on the bar. He grimaced as he lit his pipe. "Take this certificate," he said, uttering a common thought of graduating trainees, "if only it was a diploma from an accredited engineering college I could land a job with Sperry, or Westinghouse or General Electric. I'd be in line for a job as government inspector of materials, too." (Inspector, Engineering Materials, No. 103, salary \$2,600 a year.)

400 HOURS

"At the beginning of the semester," said the young man, "I said to myself, 'when I get in 400 hours at the school I'll be able to shout, *Hallelujah, I'm in the Army now!*' My dreams of chasing the elusive dot and the wily dash, while observation planes roar overhead in spying and reconnaissance, were going to come true. Well, the drums are rolling. But with my lousy 5 words a minute, I couldn't pass a test for an amateur license!"

"I know how you feel," said the center man. "I sacrificed my Christmas holidays because I thought mechanics were just as important as soldiers. Perhaps sheet metal workers, woodworkers, machinists, tool makers, lathe operators, and the like are as important. But radio mechanics . . . I must have gone to the wrong school . . . or maybe we're in the wrong business!"

THE OTHER SIDE OF THE STORY CONCERNING THE "REFRESHENER" RADIO COURSES DISCUSSED BY MR. FENWAY

This article gives one side of the story concerning the teaching of radio in the special classes now operating throughout the country as part of the Defense Program. The other side of the story—that of the Government—will be told in a subsequent article. For, there is a certain amount of justification for the statements Mr. Fenway makes, while at the same time these statements should be considered in the light of certain objectives, and accomplishments in these directions, which again brings us face to face with the fact that the other fellow may have something to say—and, in this case, does.

Meanwhile, and until the next article on this subject appears, it is suggested that *Radio-Craft* readers send us their comments on Defense radio teaching conditions as they find them in their own localities.

Are these courses really fitting men for better radio positions in Government services and private industry?; and, are those who graduate really being absorbed by Government or Industry, or are they receiving no material benefit from these courses?

What good is the Radio Defense Program? That depends upon what is expected of it. If radio workers expect the government to take radio seriously* at a time when aeroplanes, battleships, bullets, and so on are needed badly they are likely to be greatly

*Sec Editorial, in this issue, pg. 9.—Editor

All of the attractive items listed here are brand new. ALL are in PERFECT WORKING ORDER. In many cases, the parts alone total more than the price we are asking. 100% satisfaction guaranteed or your money refunded.
ORDER FROM THIS PAGE. Use the convenient coupon below. Include sufficient extra remittance for parcel post charges, else order shipped express, collect. Any excess will be refunded. C.O.D. shipments require 20% deposit. If full remittance accompanies order, deduct 2% discount. Send money order, certified check, new U. S. stamps. No C.O.D. to foreign countries.

ORDER TODAY LIMITED QUANTITIES PROMPT SHIPMENTS ASSURED

VARIABLE SPEED UNIVERSAL MOTOR

FOR 110 VOLTS, A.C. OR D.C.

Made for Dictaphone machines by American Gramophone Co. Used, but in excellent condition. Special lever control permits variable speeds up to 3000 r.p.m. 1 1/2" shaft extends from both sides of motor. Measures 7 1/2" x 3 1/4" diam. overall. Shp. Wt. 6 3/4 lbs.

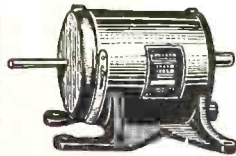

ITEM NO. 11
 Your Price . . . \$1.55

POWERFUL ALL-PURPOSE INDUCTION MOTOR

IDEAL FOR EXPERIMENTERS—101 USES

Sturdily constructed to precision standards, this self-starting shaded pole A.C. induction motor is powerful enough for a large variety of uses. Some of these are: Automatic Timing Devices, Current Interrupters, Electric Fans, Electric Climes, Window Displays, Photocell Control Devices, Electric Vibrators, Small Grinders, Buffers and Polishers, Miniature Pumps, Mechanical Models, Sewing Machines, Phonograph Motors, Coffee Grinders, Motion Picture Projectors, Motorized Valves, Sirens, and other applications.

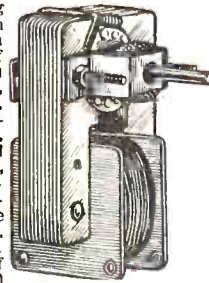

Consumes about 15 watts of power and has a speed of 3,000 r.p.m. When geared down, this sturdy unit will constantly operate an 18-inch turntable loaded with 200 lbs. dead weight—**THAT'S POWER!**

The motor is of midsize dimensions, 3 inches high by 2 inches wide by 1 3/4 inches deep; has 4 convenient mounting studs; shaft is 7/8" long by 3/16" diameter, and runs in self-aligning, oil-retaining bearings; the best materials, perfect precision assembly and rigid inspection certify to its high quality, and assure long life. Designed for 110-20 volts, 50-60 cycles. A.C. only.

ITEM NO. 147
 YOUR PRICE . . . \$1.29

WESTINGHOUSE WATTHOUR METER

Completely overhauled and ready for immediate service. Designed for regular 110-volt, 60 cycle 2-wire A.C. circuit. Servicemen use it in their shops to check current consumption of sets, soldering irons, etc. Keeps costs down. If dismantled, the parts alone would bring the price. The elaborate gear train could be used as a counter on machines of various kinds. Simple to install: 2 wires from the line and 2 wires to the load. Sturdily constructed in heavy metal case. Size: 8 1/2" high, 6 1/4" wide, 5" deep, overall. Shp. Wt. 14 lbs.



ITEM NO. 33
 Your Price . . . \$4.50

100 POWER TELESCOPE LENS KIT



Make your own high powered 6 ft. telescope! Now you can thrill to a closeup view of the worlds out in space. See the rings around Saturn, the mountains of the moon! Kit contains 3" diam., 75" focal length, ground and polished objective lens and 2 astronomical eye-pieces, magnification 50x and 100x. Complete kit with full instructions.

ITEM NO. 123
 YOUR PRICE . . . \$1.95

NEW—EXTRA LARGE LENS KIT—contains completely finished 4" diameter 100" focal length ground and polished objective lens, three 1 1/2" diameter eye-pieces giving 68x, 133x, and 200x, an aluminized diagonal for overhead viewing, and a color filter for insertion in any eyepiece.

ITEM NO. 123L
 YOUR PRICE . . . \$3.95

AMAZING BLACK LIGHT!!

Powerful 300-Watt Ultra-Violet Bulb



The best and most practical source of ultra-violet light for general experimental and entertainment use. Makes all fluorescent substances brilliantly luminescent. No transformers of any kind needed. Fits any standard lamp socket. Made with special filter glass permitting only ultra-violet rays to come through. Brings out beautiful opalescent hues in various types of materials. Swell for amateur parties, plays, etc., to obtain unique lighting effects. Bulb only. Size of bulb. Shp. Wt. 1 lb.

ITEM NO. 87
 YOUR PRICE . . . \$2.00

WELDING! BRAZING! SOLDERING!

3-IN-1 PORTABLE ELECTRIC TORCH

WORKS FROM 110 VOLTS A.C. OR D.C. LINE

This electric torch is not a gadget or a toy but a sturdily built outfit using the finest materials. With it you are able to do professional type of welding, brazing and soldering work, regardless of whether or not you've had previous experience. It will do a thousand and one jobs: fender welding, auto body repairs, bumpers, cylinders, tanks and industrial repairs—ideal for steel fitters, plumbers, sheet metal jobs, engineers, maintenance men, radio and bicycle repair men, etc. Works on aluminum, brass, copper, iron, steel and other metals!

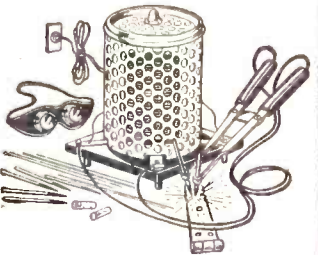

The 3-in-1 electric torch is so simply constructed that even a boy can operate it after reading the simple and concise instructions furnished with the unit. Not necessary to know how to strike an arc! All you do is plug the torch into the light socket, adjust the carbons per instructions, and presto!—you have an intense, blazing flame, ready for work. The outfit comes complete with power unit, electric cord, electrode holder, carbons, welding rods, brazing rods, solder flux, goggles, and instructions.

Save money! Do your own repairing. Earn money by doing repairing for others. Simple, practical, durable and safe to handle—that's why the price is amazingly low. Don't delay—order one today. Shp. Wt., 8 lbs.

ITEM NO. 50
 Your Price . . . \$6.95

ELECTRIC HUMIDIFIER FOUNTAIN



Adds healthful moisture to the air in winter. Evaporates as much as a pint of water in 24 hours. Fountain is 14" in diam. Sprays 8 streams of water 5" above fountain head. Made of spun aluminum. Comes in five colors: Bronze, chrome, copper, red, green. No water connections required. Just plug into 110 volt, 60 cycle

A.C. outlet. Current consumption few cents a month. Complete with base switch and 8 ft. power cord. Shipping wt. 9 lbs. List price \$14.95. Only a limited supply on hand.

ITEM NO. 125
 YOUR PRICE . . . \$4.95

1941 Catalog

A POSTAL CARD BRINGS IT TO YOU

SEND FOR IT TODAY

HUDSON SPECIALTIES CO., 40 West Broadway, N. Y. C.

IT'S EASY TO ORDER—CLIP COUPON—MAIL NOW ORDER FROM THIS PAGE.

HUDSON SPECIALTIES CO., 40 West Broadway, Dept. RC-741, New York, N. Y.

I have circled below the numbers of the items I'm ordering. My full remittance of \$..... (include shipping charges) is enclosed.

OR my deposit of \$..... is enclosed (20% required), ship order C.O.D. for balance. No C.O.D. order for less than \$2.00. (New U. S. stamps, check or money order accepted.)

Circle Item No. wanted: 11, 33, 50, 87, 123, 123L, 125, 147

Name Address

City State

Send remittance by check, stamps or money order; register letter if you send cash or stamps.

• RADIO DEFENSE •

disappointed. At least it would seem so. For example: look up an article entitled, "Hemisphere Defense" by Mr. Louis Johnson, Assistant Secretary of War, in last July's *Atlantic*. Mr. Johnson mentions everything necessary for an adequate defense except Radio.

Radio men may or may not be surprised to learn that another article, notably longer and greater than average, entitled, "Wanted: A Plan for Defense," appeared in *Harper's Magazine* in August, 1940. This brilliant vehicle by Mr. Hanson W. Baldwin, of the *New York Times*, completely ignored any part that radio might be expected to play in a National Defense set-up. In fact, the word "radio" was not mentioned *once* in the entire article!

Had you called this sin of omission to Mr. Baldwin's attention, he may have said, raising an eyebrow, "Radio?"

And immediately afterwards you'd have wished the subject had never come up. You should have known he'd expect you to take cognizance of the Government's enrollment of radio men for military and other services. If you were past the age limit, or not quite expert enough to pass a rigid Civil Service examination—well, that was just one of those things.

Three radio men who can present a steel-riveted case of their willingness to work if given a job, loaf at a Manhattan bar. They have shown the right spirit by applying for work at places where radio Defense work was supposed to have reached war-time schedule.

"Maybe," someone says, "they lack sufficient training to cope with the rearmament set-up."

If such be the case, the blame lies not with the men, but with the Defense schools.

Let's look into it, and see if the schools are lagging. Let's find out what an average

trainee learns at an average Defense school.

First of all, in the State of New York, up to February 1st, 1941, the money furnished by the Office of Education for vocational training of *defense workers* amounted to \$3,378,940. Such a goodly sum ought to give aspiring radio men—beginners as well as those who have been struggling to little-appreciable result—a solid foundation and skill with tools, test instruments, and formulas essential for a correct understanding of the subject.

It is necessary to bear in mind, however, that most of the schools had nothing to go by—no special Defense program. The time was so brief, some of the teachers sent out SOS calls to various government agencies, asking for definite help with a schedule. But in vain. No special program existed. No one knew when it would exist. Someone with prophetic insight might have realized that our country is dotted with fine radio schools, any one of which would have been honored to furnish such a program. As it turned out, "our" school, like several others, got up a course fashioned after the one used at the Signal Corps of the United States Army.

But with this difference: our school had none of the characteristics of a text-class. It wasn't essentially a course for the novice, nor one that could be taken profitably by those already infected with radio bacilli. Moreover, you couldn't have called it a heart-to-heart talk between a person who knows and another who seeks knowledge.

The outline that follows may sound rather impressive, actually there was too much flitting from subject to subject . . . and perhaps too much fooling around with ill-conceived projects—mechanical drawing of blocks, instead of radio schematics; electrical mathematics in place of radio mathe-

A COURSE WITHOUT FUNDAMENTALS

Out of the very top drawer of the classroom we pick these facts:

Alphabetical code practice . . .	100 hours
<i>(In August 1918, radio men attending the U.S. Naval Radio School in Cambridge, Mass., were instructed to receive code at 22 words a minute—later, 25 words was the passing mark.)</i> ⁽¹⁾	
Traffic practice	0 hours
Radio procedure routines	30 hours
Operation of field nets	0 hours
Teletype operation	0 hours
Trouble shooting or bug-hunting	20 hours
<i>(Bug-hunting in electrical parlance is the interesting art of locating trouble in a circuit.)</i>	
Principles of electricity	50 hours
Mechanical drawing	100 hours
Mathematics	100 hours
<i>(Very little radio math was given; mostly, Elements of Electricity for Technical Students.)</i> ⁽²⁾	
Shop work	50 hours

At first, shop work consisted of repairing sets left at the school. Later, constructional kits were available. If a man could afford to buy his own parts and chassis he was permitted to build anything he liked. While the school had many fine pieces of test equipment, little or no instruction was given in the proper use of it.

ONLY DOING THE SPADEWORK

Trainees began to realize more and more that they would get the spadework only, in 400 hours. There seemed to be a race against time. With the result that no one received

⁽¹⁾ The Oscillator, July 27, 1918.
⁽²⁾ W. H. Timble, "Elements of Electricity."

(Continued on page 54)

Mr. Serviceman! Get your RSA Membership



FREE!

Now without one cent of cost to you, you can have a membership in the RSA, the only national organization that has the sponsorship of the RMA, the NAB, the Sales Managers' Clubs and the Trade Journals.

This includes the RSA Membership Certificate, the RSA Pocket Membership Card, the House Organ, access to the RSA Technical Helps Bureau, and participation in all the functions and benefits RSA offers!

Act Now! Take Advantage of this Special Offer!

RADIO SERVICEMEN OF AMERICA, INC.

"Reliable Service Assured"

**JOE MARTY, JR., EXECUTIVE SECRETARY
304 S. DEARBORN ST., CHICAGO, ILLINOIS**

It's simple! . . . easy! All you have to do is send in 5 memberships of your fellow Servicemen with a \$5.00 bill (that's \$1.00 for each) for 1941 National RSA Dues, and you get your membership *Free* of charge. Applicants in present chapter areas will be referred to the local chapter.

RADIO SERVICEMEN OF AMERICA, INC.
304 S. Dearborn Street, Chicago, Illinois

- \$5.00 enclosed for 1941 National Dues for 5 memberships in RSA. Names and addresses attached herewith.
- \$1.00 enclosed for 1941 National RSA Dues for single membership.

Name

Address

City State

Radio-Craft—July '41

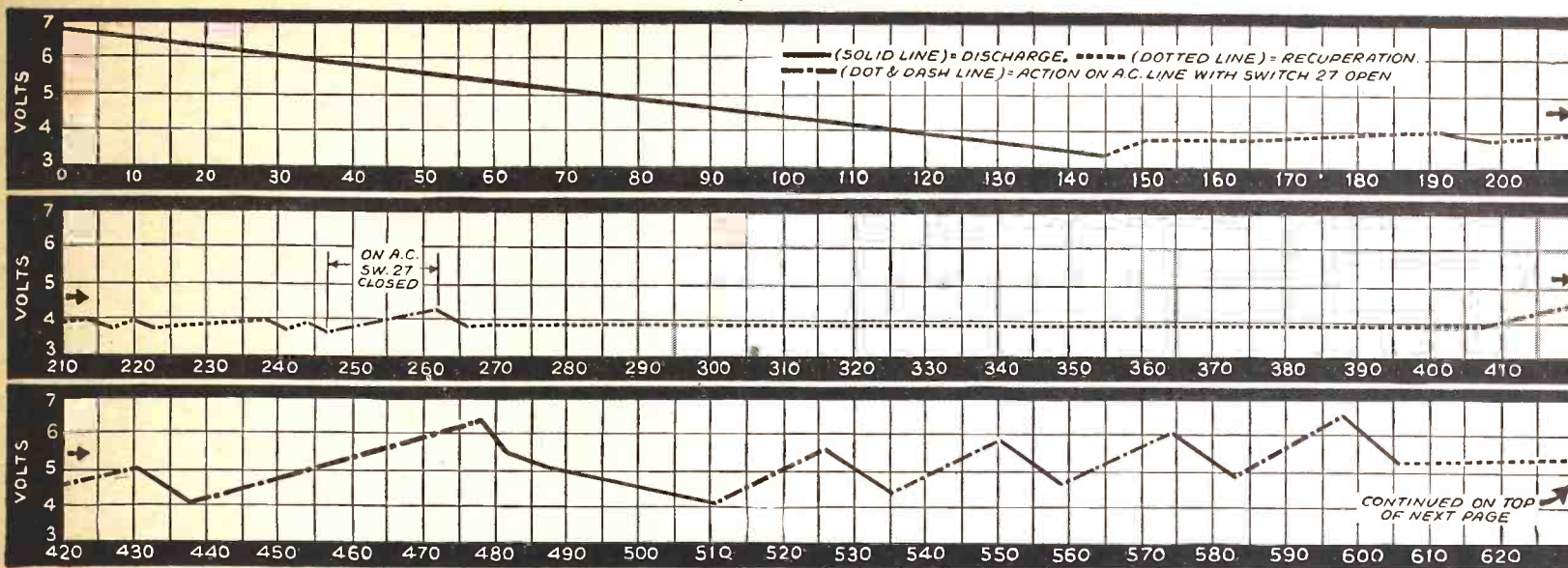

REJUVENATING DRY BATTERIES!



Automatic Radio Co.'s "Tom Thumb" Personal Battery/Electric Portable, with antenna built into front-door and power cord recessed into back-door.

"It can't be done," the experts said, when the inventor of the patented circuit here described in this article, exclusive to Radio-Craft, first claimed he could recharge dry-batteries. Read how he accomplishes longer battery life and instant battery/electric operation in Battery Portables.

BENJAMIN S. VILKOMERSON

SEVERAL years ago, in the course of designing a portable radio receiver capable of operating on (1) self-contained dry-batteries, or (2) A.C. or (3) D.C. power lines, the writer saw some advantages both in reduced manufacturing cost and in performance characteristics, to an arrangement which would require no switch in changing from battery to power-line operation. As the contemplated arrangement called for floating the batteries across the output of the power-supply rectifier, it was decided to conduct some tests to determine just how practical such an arrangement would be.

The tests conducted were along the following general lines:
 (1) Effects on battery life
 (2) Effects on tube life
 (3) Effects on set performance

BATTERY LIFE

In regard to battery life, it was known that any increase in temperature, seriously reduced battery life, due to both accelerated local chemical action and to loss of moisture. To keep the heat emanating from the power-supply resistors and the rectifier tube from injuring the batteries required proper placing of components, and exceptional attention to cabinet design, to obtain as much ventilation as possible. This problem would be encountered with any set which

contained both batteries and a power-supply—regardless of whether or not the batteries were floated on the power supply.

The possibility that the A.C. component in the rectifier output might reduce battery life either by raising the internal temperature of the battery or otherwise was investigated. The A.C. component in the rectifier output was measured and found to be very small; much too small to cause any significant rise in temperature. Ten times the normal value of the A.C. component was passed through a group of 10 batteries for 200 hours. (The normal operating life of the batteries was about 100 hours.) This group of batteries was then discharged along with another group of batteries of the same make and date of manufacture, which

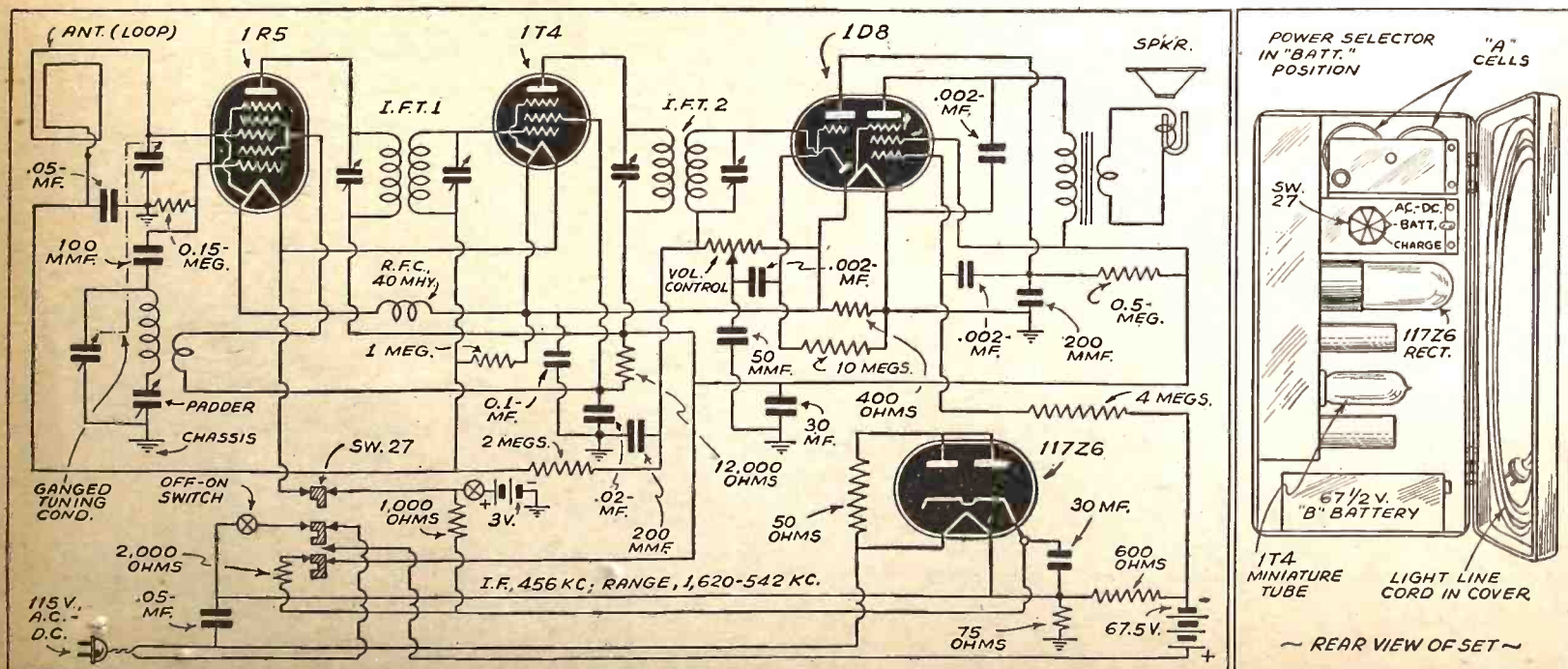

Schematic circuit, left of the "Tom Thumb" personal Battery/Electric Portable Radio Set shown pictorially on this page. When connected to an A.C. or D.C. electric light line the dry-batteries are rejuvenated by a patented recharging process. In illustration at right, note that the switch (located on the back of the set) has a position marked CHARGE. The power cord, incidentally, when not used in electric operation is concealed by winding it on 4 supports recessed into the back-cover, which opens on a hinge.

For Better Servicing - For Bigger Profits -

FOR A WIDER KNOWLEDGE OF TECHNICAL SUBJECTS, READ THE BOOKS IN THE RADIO-CRAFT LIBRARY SERIES

GET into the swing of reading instructive, authoritative books on technical subjects—Radio, Air Conditioning and Refrigeration. The RADIO-CRAFT LIBRARY SERIES is the most complete set of volumes individually treating all important divisions in these fields. Each book has been written for the purpose of giving you the opportunity to specialize in one or more of the popular branches of the various subjects and we know of no easier, quicker or less expensive way to improve your knowledge. The material in each book is very helpful—you'll find them valuable in your work. The authors are all well known and are authorities on the subjects on which they have written. This is the first time that you are enabled to build a library of technical books by such popular writers.

ALL BOOKS ARE UNIFORM

The books in the RADIO-CRAFT LIBRARY SERIES are all uniform. The size is 6 x 9 inches. Each volume contains 64 pages and an average of 50 to 150 photographic illustrations and diagrams. The books are printed on an excellent grade of book paper and have stiff flexible covers. PRICE 50c PER BOOK. All books are sent postpaid.

 <p>Book No. 13 ABC OF AIR CONDITIONING An accurate simplified technical review of the fundamentals of this latest branch of engineering, including servicing data on present-day units. By Paul D. Harrigan. 50c</p>	 <p>Book No. 17 SERVICING WITH SET ANALYZERS A Study of the Theory and Proper Application of Modern Set Analyzers and Associated Apparatus. By H. G. McEntee. 50c</p>	 <p>Book No. 21 BREAKING INTO RADIO SERVICING Simple Instructions and Procedure for Starting a Profitable Radio Servicing Business of Your Own. By Robert Eichberg. 50c</p>
 <p>Book No. 14 POCKET RADIO GUIDE Edited by N. H. Lessem. Handy Reference Book for Radio Men—Set Construction Articles—Audio Amplifier Circuits—Useful Radio Formulas and Data—Handy Short-Cuts. 50c</p>	 <p>Book No. 18 POINT-TO-POINT RESISTANCE ANALYSIS For Service Men Theory—and Application of this Modern Test Procedure to Everyday Radio Service Problems. By Bertram M. Freed. 50c</p>	 <p>Book No. 22 NEW RADIO QUESTIONS AND ANSWERS Answers to Questions Most Frequently Asked by Both Novices and Experts. By Robert Eichberg. 50c</p>
 <p>Book No. 15 ABC OF REFRIGERATION A carefully written volume, starting with the basic principles of refrigeration by mechanical means, and leading up to a complete analysis of the servicing of commercially available units. By Trafton Mason. 50c</p>	 <p>Book No. 19 PRACTICAL RADIO KINKS AND SHORT CUTS The contents of this book have been planned with the view to help Radio Dealers, Servicemen, Experimenters and Set Builders. By B. Baker Bryant. 50c</p>	 <p>Book No. 23 PRACTICAL PUBLIC ADDRESS Modern Methods of Servicing and Installing Public Address Equipment. By B. Baker Bryant. 50c</p>
 <p>Book No. 16 PRACTICAL RADIO CIRCUITS A Comprehensive Guide to All Types of Radio Circuits for the Serviceman, Constructor and Experimenter. By David Bellare. 50c</p>	 <p>Book No. 20 THE CATHODE-RAY OSCILLOSCOPE Theory and Function. Power Supplies and Associated Circuits. Sweep Circuits, Operation of Typical Unit. Methods of Measurement, Practical Applications of C-R Oscillographs. By Charles Scuranza. 50c</p>	 <p>Book No. 24 AUTOMOBILE RADIO PRINCIPLES AND PRACTICE A Complete Treatise on the Subject Covering All Phases from Installing to Servicing and Maintenance. By B. Baker Bryant. 50c</p>

New titles are constantly being added to the RADIO-CRAFT LIBRARY SERIES. But, on the other hand, stocks of certain titles are running low, and they may not be reprinted for some time. We would therefore suggest that at this time you order as many different titles as you are interested in. Remember, that if you delay, some of the books may later be out of print.

RADCRAFT PUBLICATIONS, Inc., 20 VESEY ST., NEW YORK, N. Y.
Gentlemen: Enclosed find my remittance of \$..... for which send me, POSTPAID, the Books indicated below.

RADIO-CRAFT LIBRARY SERIES @ 50c EACH

Circle book numbers wanted: 13 14 15 16 17 18 19 20 21 22 23 24

Name Address

City State

(Send remittance in form of check or money order; register your letter if you send cash or unused U. S. Postage Stamps.)

RC-741

USE THIS HANDY COUPON WHEN ORDERING

RADCRAFT PUBLICATIONS, Inc.
20 VESEY STREET NEW YORK, N. Y.

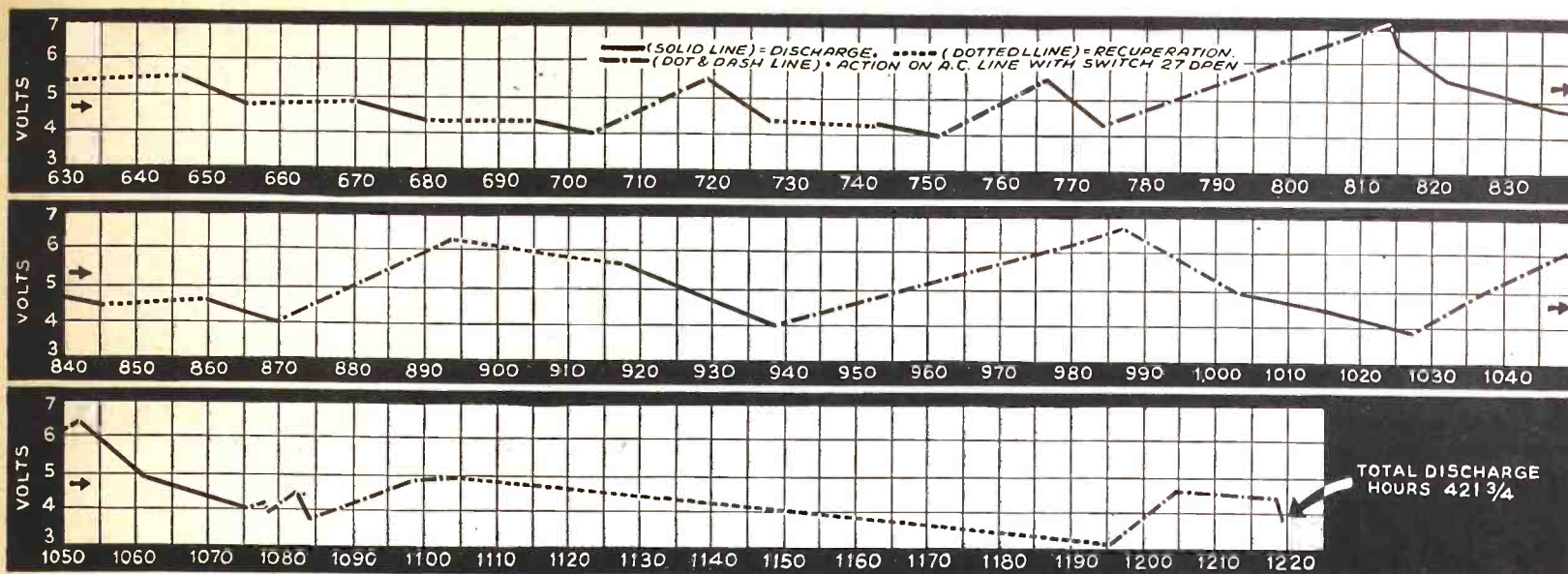

had not been subjected to any A.C., and no difference was discernible in the average operating life of the 2 groups of batteries.

Performance checks were made on a set which first was run on battery power until the batteries were exhausted to the point where reception stopped, and then the set was connected to a power-line. The set started operating as soon as the rectifier tube heated up. A voltmeter connected across the batteries showed an immediate voltage rise due to a reversal in the direction of the current through the internal resistance of the batteries; after which the voltage kept on rising gradually until the voltage across the batteries equaled the voltage which would be developed across the same points with the batteries disconnected.

Since the internal resistance of the batteries is practically always lower than that of the rectifier power-supply, the batteries determine the operating voltages of the tube elements. At the reduced battery voltages, the tubes take less plate and filament current. As the rectifier circuits were designed to supply normal filament and plate current, the excess current, which is the difference between the reduced-voltage consumption of the set and the normal-voltage current supply of the rectifier system goes to charging-up the dry-batteries.

When the batteries have been charged-up to the floating voltage, if the powerline is then disconnected, the batteries will continue to operate the set until the voltage falls to the cut-off value. This cycle of charge and discharge can be repeated a great many times.

THE ECONOMY OF "RECHARGING"

As the difference between the current consumption at the reduced voltage of the low batteries and the normal value of current supplied by the rectifier is the part of the rectifier output effective in charging the batteries, the set must be operated on the powerlines for quite a while to bring the batteries up. The charging can be made much faster and more complete by opening the filament circuit of the set. This stops both the "A" and "B" current consumption of the tubes, so that all the power goes to charging the batteries. Tests conducted using this last charging arrangement showed that batteries that had been discharged in the ordinary way and had given the normal number of hours of service could be recharged and discharged time and time again, so that the aggregate of discharge hours on battery operation came to between 2 and 5 times more than the original normal life of the battery.

As the battery gets older, the length of time it will operate the set on discharge gets shorter, and the length of time re-

quired to bring it up to full voltage likewise gets shorter, and charging it for a longer time serves no useful purpose. The end of battery life is reached when the discharge time becomes too short to be useful. The benefit achieved by recharging decreases as the battery dries out with age, and differs considerably with batteries of different makes which employ different "mixes" in the cell construction. Of several makes tested by the writer, some makes which gave only ordinary performance when used in the ordinary way seemed to be especially adaptable to recharging, while one make of battery was found, which while it gave definitely superior results on its initial discharge (about 40% longer life than others of the same size), could be made to give only a few extra hours of service by rejuvenation, as the zinc shell seemed to be quite eaten-through by the initial discharge, before rejuvenation was started.

After the writer had definitely satisfied himself as to the practicability of recharging dry-batteries, he was referred to a paper published in the *Proceedings of the*

this floating voltage was made somewhat lower than the full fresh battery voltage. This meant that a fresh set of batteries carried a small part of the load for a time even on electric operation, which would be expected to cut down the battery life somewhat, but this loss was far more than compensated-for by the many added hours of service secured by rejuvenation when the battery voltage fell below the "floating" voltage.

Besides additional life, other advantages of the floating battery arrangement are:

Greatly reduced hum during A.C. operation with a minimum of filter (a good battery is equal to thousands of microfarads of filter capacity);

Freedom from fluctuations in reception due to line voltage changes;

No change-over switch for changing from Power to Battery operation, and vice versa, when employing the circuit described further, and immediate (1 to 2 seconds) operation of the set when it is turned on, even when it is plugged into the line power supply, without the use of magnetic or other devices which operate mechanically to change from Battery to Electric operation after the rectifier heats up.

This immediate operation, which the writer considers a very desirable feature, is due to the set operating on battery power as soon as the switch is turned on; when the rectifier heats up, it takes-over the load, while the battery (a) floats or (b) charges, according to the voltage conditions. There is no wait for the rectifier to heat up, and no noticeable interruption or change in performance from the time the set is turned on (when no powerline output tube is used).

SET PERFORMANCE

The switch mounted on the back of the ordinary volume control can accommodate not more than 2 poles, in single throw. One pole is connected in series with the "A" cell and the other in series with the powerline. The more common rectifier arrangement using 1 cathode (or both cathodes connected together) and a divider network to secure "A" and "B" voltages would cause the "B" battery to discharge through the "A" cell in the absence of a power changeover switch when the line-power is turned off. By using the 2 cathodes of the rectifier tube (25Z6, 50Y6 or 117Z6) separately, one for "A" supply and one for "B" supply, the only common connection between the "A" and "B" circuits is to the "high" side of the line through the emission current of the rectifier, so that when the heater circuit is opened and the cathodes cool off, the "A" and "B" circuits are not connected.



American Electro-Chemical Society, in 1938, in which the results of a quite extensive series of experiments on recharging dry-cells led to the conclusion that about 4 times normal life could be secured from ordinary dry-cells by recharging, and in the discussions that followed the reading of the paper, others who had experimented along the same lines claimed to have consistently secured as high as 10 times the normal life by slight modifications of the chemical constituents of the cell! These results seemed to be quite in line with the writer's own findings.

TUBE LIFE

The rated voltage on drycell tubes is 1.4 volts. A fresh drycell gives 1.54 volts. By proper choice of values of the rectifier circuit components any desired voltage may be obtained at rated line voltage on both A.C. and D.C., and this will be the voltage at which the batteries will stabilize or "float" on A.C./D.C. operation.

In the interest of maximum tube life,

The 60-milliamper pilot light in series with the "A" rectifier circuit serves 2 purposes. (1) It indicates, when it is lighted, that the power is being supplied from the powerline, and (2) it also indicates, by lighting up, the correct plug polarity on D.C. supply. If this pilot light indicator were not used, the set might be operating from the battery power while the plug is attached to a defective or inoperative electric socket, or with reversed polarity on a D.C. line, and the user might not know the difference until the batteries became exhausted.

IMPROVEMENT

A subsequent improvement to the set was made by connecting a 50L6 beam power output tube with its heater in series with the

heater of the 50Y6 rectifier, its control-grid coupled to the control-grid of the battery-operated output tube, and the loudspeaker voice coil coupled to both tube plate circuits by means of a transformer having 2 primaries and 1 secondary, the primaries being so proportioned that the proper load impedances are coupled into the respective tube plate circuits.

Thus when the set is not connected to a powerline, it operates as a straight battery portable. No switching is required to change from battery to powerline operation, or vice versa. When the set is connected to a powerline socket, and the operating switch is turned on, the set starts to operate immediately from its self-contained batteries. As soon as the 50Y6 and 50L6 cathodes come up to operating temperature, the batteries

"float" and the 50L6 takes over the power output function almost entirely. This is evidenced by greatly increased power output and better quality of reproduction. (The battery-operated power-output tube has a maximum output of about 170 milliwatts, while the powerline-operated power-output tube has an output of over 2 watts, or more than a 10-fold power increase.)

Most of the novel features of this receiver are covered by a U. S. patent granted to the writer (No. 2,222,196). To date, 2 receiver manufacturers have been licensed under this patent (Automatic Radio Mfg. Co. of Boston, and the Emerson Radio & Phonograph Corp. of New York).

This article has been prepared from data supplied by courtesy of Automatic Radio Mfg. Co., Inc.

HOW THE RADIO INDUSTRY HAS GROWN

IN terms of the total number of radio receiving sets produced (10,352,865 reported by number in the last Census of Manufacturers), the year 1939 was the biggest in the Radio Industry, according to the Bureau of the Census.

The number of sets made in 1939 exceeded the comparable 1937 total of 7,802,399 sets by 2,550,466 units. The year 1935 ranked 3rd in the list of years for which Census data are available with 5,645,162, and 1929 was 4th with 4,980,090 sets.

First in rank, in terms of factory value of radio sets for which the quantity in numbers was reported by manufacturers, was 1929 with \$252,787,249; 2nd, 1937, with \$175,380,012; and 3rd, 1939, with \$158,965,359. These totals reflect the steady reduction in unit price of radio receiving sets during the decade following the 1929 Census.

Comparable totals, on total units of all kinds of radio receiving sets reported by number and their value, for all Census years for which separate figures are available, follow:

Year	Number	Factory Value
1939	10,352,865	\$158,965,359
1937	7,802,399	175,380,012
1935	5,645,162	132,683,691
1933	3,629,614	70,717,100
1931	3,819,285	123,016,150
1929	4,980,090	252,787,249
1927	1,978,057	95,162,393
1925	2,345,790	93,356,546
1923	190,374	13,326,116

Since 1931, the Census Bureau has collected statistics on radio receiving sets for home or general use, giving data separately on those covering the standard broadcast band and those extending beyond the standard band (combined Standard and Short-wave sets), which give revealing information on the trend.

The following tabulation presents, in separate columns, the number of standard band and beyond-standard band units, and their combined total, by years:

Year	Stand-ard Band	Beyond-Stand-ard Band	Total
1939	5,361,349	2,894,901	8,256,250
1937	2,280,322	3,563,247	5,843,569
1935	1,437,245	2,960,559	4,397,804
1933	2,781,445	115,519	2,896,964
1931	3,523,733	11,078	3,643,383

Statistical testimony on the increasing popularity during the last decade of radio-phonograph combinations for home receiving sets is given in a tabulation based upon returns of the last 5 biennial Censuses of Manufacturers.

Production of radio-phonograph combi-

nations in 1939, the last Census year, totaled 474,823, more than double the sum of units reported in the 4 previous Censuses. The factory value of these units in 1939 was reported at \$17,193,408.

Radio-phonograph combinations, made in U.S. factories, as reported at the last 5 Censuses of Manufacturers, and their value at the factory, were:

Year	Number	Factory Value
1931	73,603	\$6,310,442
1933	30,092	1,407,650
1935	23,362	2,461,346
1937	57,807	4,567,342
1939	474,823	17,193,408

Steady growth in the branch of the U.S. radio industry devoted to the manufacture of automobile radio receiving sets also is shown in Census statistics.

In 1931, the first year for which separate figures are available, U.S. radio manufacturers produced 96,145 automobile sets valued at \$3,076,191. In 1939, the latest year covered by the Census, radio factories reported a production of 1,587,227 sets valued at \$27,715,879.

The biggest year for automobile radio manufacturers during the 1931-1939 period, however, was 1937 when 1,890,841 sets valued at \$38,679,145 were reported.

The number and value at the factory of automobile sets, by Census years since 1931, are given in the following table:

Year	Number	Value
1931	96,145	\$ 3,076,191
1933	700,018	13,597,863
1935	1,191,758	25,556,018
1937	1,890,841	38,679,145
1939	1,587,227	27,715,879

According to a special survey conducted by the Bureau of the Census at the request of the Automobile Manufacturers Association and the Automotive Parts and Equipment Manufacturers, Incorporated, the sale of automobile radio sets to channels in the U.S. market in 1939 numbered 1,359,876 units. This figure combines units sold for distribution to car owners and units installed by vehicle manufacturers on cars for the United States market.

As reported to the Census Bureau by radio manufacturers, the number of police radio receiving sets made, and their value at the factory, was:

Year	Number	Value
1933	1,276	\$ 46,507
1935	3,149	218,216
1937	6,269	375,273
1939	4,442	272,351

Our Ailing Radio Defense Program

(Continued from page 50)

a thorough grounding in fundamental principles essential to an understanding of Army and Navy radio equipment. Kirchoff's Two Circuit Laws, the basis of all circuit testing; instruction showing that testing is the reverse of engineering; instruction in the language of test equipment—the language of Ohm's Law, and other basic laws and basic theory—which enables a trainee to understand, not only what he is doing, but why he is doing it . . . all these things were conspicuous by their absence.

By the time 200 hours was spent, trainees commenced bombarding teachers with pertinent questions. "Are the Defense Courses," they asked, "intended for private industry, or government service?" And, "Will there be jobs for us when and if we complete the course?" As often as not, such questions were brushed aside on the grounds that they were irrelevant and premature. Once a certain teacher remarked, with a sheepish grin, "We can't hope to make engineers out of Servicemen, in 400 hours."

However, not one of the trainees cast the slightest doubt on the sincerity of the teachers. To be sure, they were far from being adequate professors, but they did take a very sympathetic attitude toward the students—sympathetic in the sense of understanding.

You can't give all radio men the same training. Not in amount, nor in kind, nor in result. You can't select for him the pill that looks easiest to swallow.

FERTILE SOIL UNPLOWED

What good is the radio Defense program?

In its present set-up it is of little value to the average radio worker and Serviceman. It might have created thousands of jobs for idle mechanics had it investigated all the possibilities of Frequency Modulation, television, facsimile transmission and the old standby, amplitude modulation.

It's up to the Federal Communications Commission, and the Defense Commission, now to take radio far more seriously and study it far more carefully, and take the men who have made it their profession far more fully into their confidence.

Apparently the Government isn't the least concerned over the supply of skilled radio workers available for immediate service. Not one of the 3,000 New York plants which have defense contracts want these radio men. Evidently, when and if radio men are needed, the Defense Schools will be expected to turn 'em out like V-8s, straight from the assembly line. If such is the case, the Defense Schools will have to turn their backs on the past 10 months of teaching, and start with a fresh sheet of drafting paper.

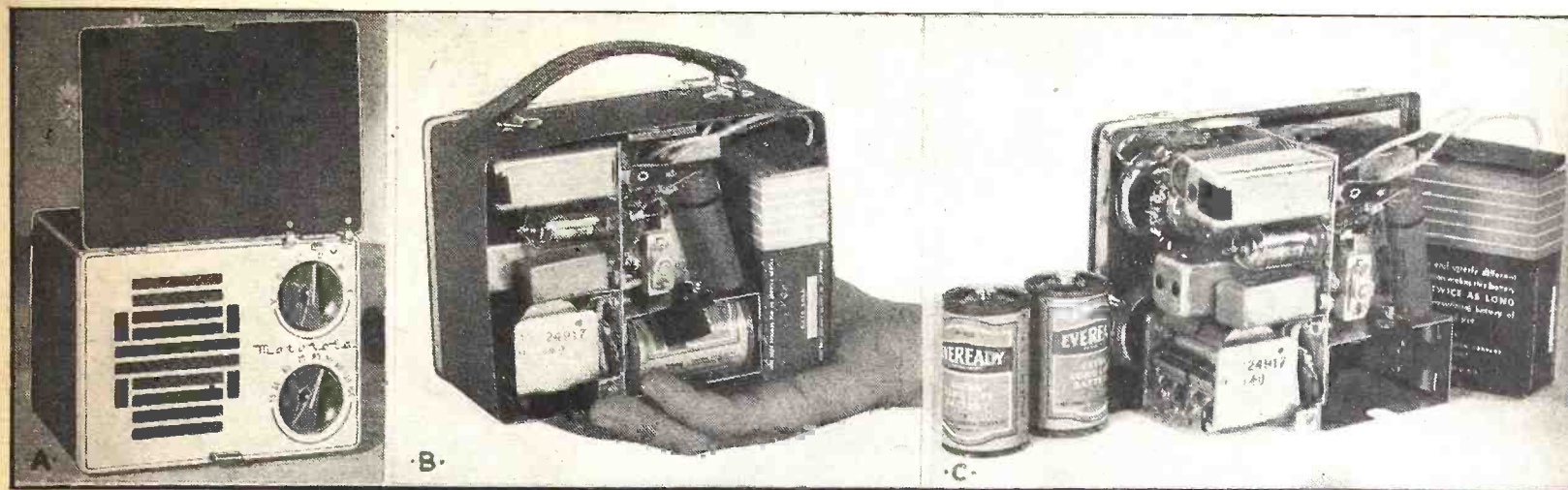

A—Motorola Model 3-A-5 Battery/Electric Personal Portable. B—Rear View of the Motorola portable showing the compactness of all the components and the assembly. A cloth tab affords quick, convenient removal of the "A" cell. C—Another view of the interior personal portable, removed from its case. Note the diminutive coils and the compact variable condenser.

MODERN MINIATURE PORTABLES

Battery portables representative of the major types—(1) the "strictly battery" and (2) the battery/electric—are illustrated and described. The problems peculiar to servicing of these sets, with their veritable "watch-size" components, also are analyzed. The author shows why "personal" portables offer better opportunities for profitable service work than preceding, larger portables.

N. H. LESSEM

WAS a time when anything with a handle was called a "portable." Even the much-heralded "low-battery drain" portables of 2 years ago—the creation resulting from the development of the 1.4 V. series of tubes—weighed as much as 16 lbs. These were swell for picnics, boatings, and extended vacation trips because of the long life of the batteries, but you had to have an automobile in which to carry them around.

From the viewpoint of the customer they were not ideal as portables. The Serviceman, however, loved them because they were nice to handle, the tubes being more or less standard size and the chassis and chassis components being no different in physical size than the ordinary A.C.-D.C. receivers to which they had become accustomed. And they brought in additional revenue from the frequent sale of tubes and replacement batteries.

WATCH-SIZE COMPONENTS

Now, however, the picture is changed because not only are the tubes themselves

smaller but all the other normally-large components, P.M. dynamic, the I.F.s, the R.F. coils, the variable condensers, even the high-capacity electrolytics, are all of watch-size proportions. Consequently, if there is anything which the modern Serviceman likes less than a headache, it's servicing the modern "personal" portables.—And manufacturers are now talking about bringing out in quantity the recently-announced, still smaller tubes, with $\frac{5}{8}$ -V. filaments!

Some time ago, your writer, noticing the trend of set design, jestingly predicted that the future Serviceman would require a set of tools akin to those of a jeweler. Today, it's no longer funny. In servicing the "personals" the Serviceman can't push aside Resistor R2 and Condenser C4 in order to get to burned-out Resistor R6. He has to unsolder a layer or two of components which are in the way. And talking about soldering—the old soldering iron will have to go in for streamlining. It's too fat and cumbersome in its present form for these "personals." Most Servicemen have to resort to the old trick of wrapping several turns of

No. 10 wire around the tip of the iron and have one end of the wire extend down to form a fine point. This works well but is a bit clumsy since it extends the overall length of the iron and is kind of wobbly. Even the task of "disrobing" the receiver—that is, getting the chassis out of its case—is a major operation in itself. No 2 sets are alike. In some of the metal-case receivers, if the bottom is removed, the sides bulge out making it difficult to get the bottom back on again. In others, in order to remove the chassis, you have to unsolder the 2 loop leads. In still others, the batteries first have to be removed and then the screws which hold the chassis to the cabinet, removed with a long-shank, screw-holding screwdriver.

But there is money in servicing these sets—which compensates for everything!

Unlike the A.C.-D.C. midgets, which could be picked-up for anywhere from \$6 in Radio Row to \$12 in the sporting-goods chain stores, these personal portables retail for about \$20, so that even if the Serviceman charges \$5 for a repair job, he cannot get the retort, "It's cheaper to get a new one."



Front and rear views of the Admiral 28-G5 5-tube Battery/Electric Portable. Ventilation for the rectifier tube is provided at the top of the molded plastic case.

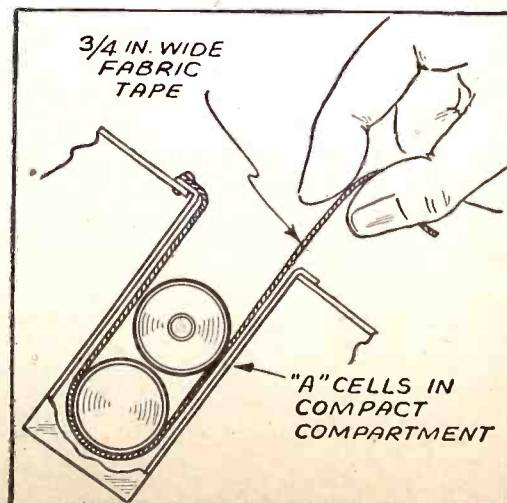

Flip the flap, and presto! the "A" cells hop into your hand. It's as simple as that.

GENERAL UTILITY 32-W. AMPLIFIER

Lafayette Radio Corp.
100 6th Ave., New York, N. Y.

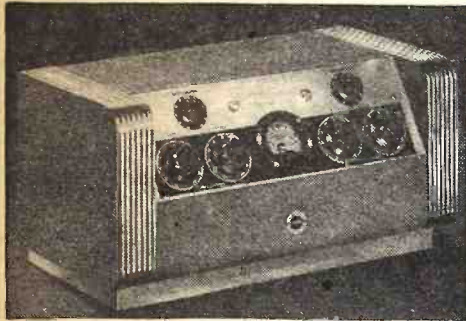

MODEL 451-T amplifier is a general-purpose unit designed to bridge the gap between "economy" and "de luxe" classes of amplifiers. It provides 32 watts of normal output and 45 watts on instantaneous peaks. It is capable of handling most types of rental or permanent job. Inputs provide for 2 mikes and 2 pickups, and mixing and fading them. Overall gain 120 db.; that of the phono channels, 92 db. Other controls include individual bass and treble equalizers and master mike gain control. Has field supply for two 2,500-ohm speakers. A universal output transformer is provided. Measures 9 x 17½ x 9 ins.; operates on 115-125 V., 50-60 cycles (or as specified).—*Radio-Craft*

UNIVERSAL AMPLIFIER

Emco Radio Products, Inc.
78 Reade St., New York, N. Y.



SPECIALY designed to give equal performance when operated either from a 6 V. battery or from the 110 V. A.C. line. Among its many features are beam power output, stand-by switch for conserving battery, unique fader-mixer system, an acoustic tone equalizer for frequency adjustment, and a built-in phono turntable and crystal pickup mounted on top of amplifier dust cover. The amplifier has a normal output of 17 W. and a peak of 23 W. Frequency response 50 to 10,000 c.p.s. Mike gain 127 db., phono gain, 76 db., hum level below rated output -66 db., output impedance 2, 4, 8, 16, 250 and 500 ohms. Size 10 x 17 x 14.—*Radio-Craft*

3 NEW ANTENNAS

Vertrod Mfg. Company
132 Nassau St., New York, N. Y.

MODEL 100 is designed for high-fidelity and broadcast receivers. This is a vertical rod antenna designed for maximum efficiency and noise elimination on the band between 500 and 1,700 kc.

Model 103 is a vertical rod antenna designed for communications receivers. This

model is most efficient on 10-, 20- and 40-meter bands, although it is claimed that it has an overall efficiency capable of covering from 500 kc. to 30 mc.

Model 104 is a vertical rod antenna designed specially for F.M. and A.M. receiver combinations. Its utmost efficiency is achieved on the F.M. band of 40 to 60 mc. and the A.M. band of 500 to 1,700 kc.—*Radio-Craft*

TIME DELAY SWITCH

Betts & Betts Corporation
New York, N. Y.

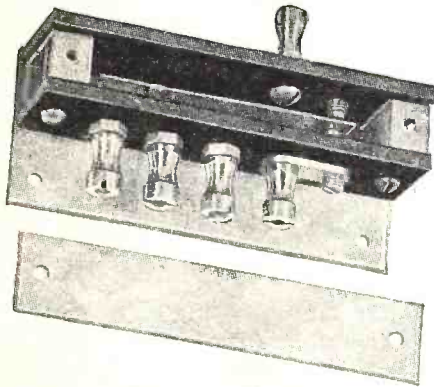

THIS new time delay switch for use in the radio industry was developed to provide a predetermined time delay in electrical control. Designed for laboratory and industrial application in conjunction with magnetic relays and generally used where temperature changes are fairly constant and slight variation in timing are not detrimental. (Special compensating switches are provided where accurate delay is essential.) The switches are made as small as technically possible without sacrificing the performance. Provided with 4 terminals, 2 for the heater coil, 2 for the main circuit and adjustable within the time limits of 1 second to 5 minutes. Available in immediately or not immediately recycling types, normally-open or normally-closed models. Size with soldering lugs 3 x 7/8 x 7/8 ins.; with binding posts 3 x 7/8 x 1¼ ins. Wiring diagrams and timing chart sent on request.—*Radio-Craft*

RECORDER—RECORD CHANGER

Allied Radio Corp.
833 W. Jackson Blvd., Chicago, Ill.



A 3-WAY instrument which provides for recording, automatic changing, record playing, and P.A. operation, all housed in a single carrying case. It is a wonderful item for home use, schools, churches, etc. Plays manually at 78 r.p.m. all home recordings or commercial records up to 12 inches in diameter. Automatically, it plays twelve 10-in. or ten 12-in. records. Built-in amplifier delivers 3 watts output. Other features include 6½-in. P.M. dynamic speaker, electric "eye" volume indicator, crystal recording head, crystal pickup, constant-speed self-starting A.C. motor, and volume and tone controls. Operates on the 110 V., 60 cycle A.C. line.—*Radio-Craft*

"ORGANETTE" SPEAKER

Atlas Sound Corporation
1443 39th St., Brooklyn, New York

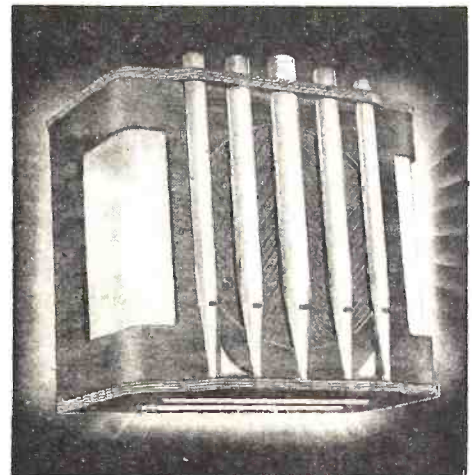

DESIGNED especially for night clubs, cafes, restaurants, and other such glamour institutions where P.A. equipment is used, model OR-12LT is a high-fidelity 12-in. combination-type speaker mounted in an illuminated "Organette" speaker housing. The housing is designed of walnut veneers and colored plastic, and is illuminated all around. Measures 17 x 13½ x 8 ins.—*Radio-Craft*

POCKET TESTER

Radio City Products Co.
88 Park Place, New York, N. Y.



THIS tester has been especially designed for checking electrical appliances. Known as model 417, the instrument is so designed as to speed-up testing, trouble diagnosing, and power-consumption demonstrations by elimination of the usual connection terminals. It is merely necessary to plug the instrument into the line and the appliance into a receptacle provided on the face of the instrument. Two 2-position toggle switches and a 3-position rotary switch permit the selection of the type of measurement to be made. Eighteen measurement ranges are provided. These include A.C. and D.C. line voltages up to 250; 4 D.C. ampere ranges up to 250 amperes; the same for A.C.; and 4 A.C. and D.C. power ranges up to 3,000 watts.

The instrument is compact, measuring 5½ x 3¼ x 2 ins.—*Radio-Craft*

• LATEST RADIO APPARATUS •

LABORATORY CONDENSER BRIDGE

The Triplett Electrical Instrument Co.
Bluffton, Ohio



MODEL 1640 condenser bridge checks the capacity, at 60 cycles, of all types of condensers—paper, electrolytic, or mica—from 0.00025-mf. to 250 mmf. Checks shorts, opens, leakage, and breakdown. Two 3-inch meters are employed. One has a GOOD-BAD scale, for leakage of electrolytics from 2 to 250 mf., based on 0.2-ma.-per-mf. at rated voltage. A control permits other ratings in milliamperes. For condenser leakage measurements both meters (voltmeter and milliammeter) are on the circuit at the same time. Tester operates from 110 V., 60 cycles A.C. line.—*Radio-Craft*

10-TUBE RECORDER-RADIO CHASSIS

Howard Radio Company
1731 Belmont Ave., Chicago, Ill.

VERSATILE chassis for the semi-professional recording studios or for installing in old or custom-built cabinets. Radio set has tuned-radio-frequency on all bands and 2 I.F. stages. Tunes 3 full bands to 13 meters. Records radio programs direct from the air, from microphone, or microphone

and radio programs can be mixed and faded. A separate channel is provided for connection of extra pickup and turntable, and records can be dubbed electrically so that singer can use a recording for musical accompaniment. Microphone can be mixed and faded while dubbing record. Supplied with 12-in. Jensen electro-dynamic speaker, Astatic crystal microphone, cutting arm and pickup, and all necessary hardware. Can also be used as a public address system. Maximum output, 11 watts.—*Radio-Craft*

MOLDED MICA CONDENSER

Cornell-Dubilier Electric Corp.
South Plainfield, N. J.

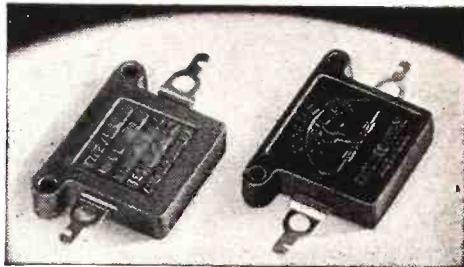

KKNOWN as Type 7, these mica dielectric condensers are moulded in bakelite and have insulated mounting holes to meet the 1½ in. standard called-for in a great number of applications.

Standard units are moulded in brown bakelite and are available in capacities beginning at 0.00005-mf. up to 0.03-mf. at 600 V.; up to 0.003-mf. at 2,500 V. Standard tolerance is ± 10%. Insulation resistance is 20,000 megohms. Each unit is clearly stamped with the capacity value, D.C. working voltage and D.C. test voltage.—*Radio-Craft*

INDUSTRIAL PAGING SYSTEM

Allied Radio Corp.
833 W. Jackson Blvd., Chicago, Ill.

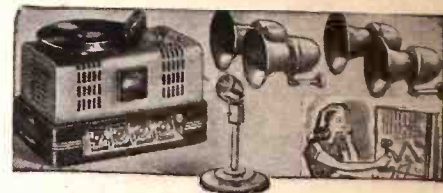

THIS paging system has been designed especially for use in factories, hotels, offices, warehouses, transportation terminals, etc. The amplifier, producing 30 watts of usable power, satisfactorily handles 4 or more 8-in. P.M. dynamic speakers. Controls are provided for regulation of output power and tone.

The system comprises a Knight 30-watt amplifier with tubes and volume level meter & Shure crystal microphone, 5 Jensen P.M. dynamic speakers, each installed in its steel projector baffle, and all necessary accessories.—*Radio-Craft*

NEW RECORDING DISC

Howard Radio Company
1735 Belmont Ave., Chicago, Ill.



ILLUSTRATED is one of the new economy recording discs in the 6½-in. size. These discs have the same type C black coating used on this company's metal-base discs which feature low surface noise and

good reproduction of both high and low frequencies. For the radio dealer and Serviceman-dealer, a new counter display is available, 11 x 14¾ ins., with easel for easy placement.—*Radio-Craft*

SAPPHIRE PHONO NEEDLE

The Electrovox Co.
424 Madison Ave., New York, N. Y.

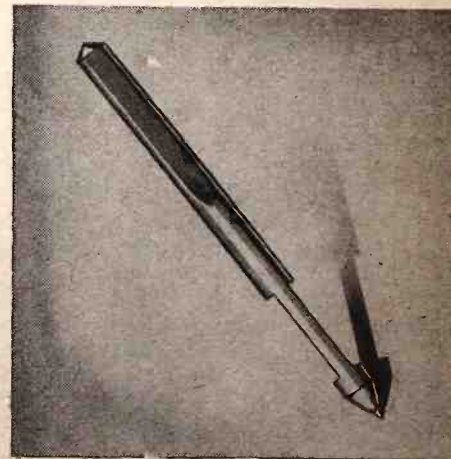

KKNOWN as model WN-55, this sapphire phonograph needle was designed especially for the new low-pressure pickups of 2 ounces or less. The stylus consists of a genuine sapphire point mounted in a straight duralumin shank which has 2 parallel in-cut flats, ground near the tip, to provide a lateral flexibility which eliminates "needle talk" and minimizes surface noise. The upper flat is for the set screw which automatically insures correct positioning in the pickup. At a pressure of 1 ounce, the needle will permit 12,000 playings.—*Radio-Craft*



Get This Electric Dry Shaver ABSOLUTELY FREE!

JUST THINK OF IT—you can get absolutely FREE, the useful DRY ELECTRIC SHAVER which is shown at the left. This ELECTRIC DRY SHAVER is sent to you by the publishers with a one-year subscription to RADIO-CRAFT.

Here Are the Features of the ELECTRIC DRY SHAVER

Constructed of metal with attractive red bronze finish. Scientifically constructed to give a perfectly clean shave. 5-foot rubber insulated cord and plug. Constructed to last for many years.

Operates from 110-volt, 60-cycle A.C. electric line. Carries a two-year manufacturer's guarantee. A fine quality, self-sharpening toilet necessity.

Send your subscription to RADIO-CRAFT for One Year (12 issues) and receive absolutely FREE one of these remarkable Electric Dry Shavers. New subscribers are accepted or you may extend your present subscription another twelve months. Mail your remittance of \$2.00 (plus 25c for shipping charges on Shaver) to the publishers. (Canada and foreign \$2.75.) You will receive your DRY ELECTRIC SHAVER immediately by return mail. Use coupon below to enter your subscription.

RADIO-CRAFT

20 Vesey Street, New York, N. Y.

RADIO-CRAFT, 20 Vesey Street, New York, N. Y.

Gentlemen: Enclosed find my remittance of \$2.00 for which enter my subscription to RADIO-CRAFT for one year (12 Issues). Send me immediately FREE, ELECTRIC DRY SHAVER (Canada and foreign \$2.75). In U. S. add only 25c additional to cover shipping charges on Shaver.

New Subscriber Extend Present Subscription

Name

Address

City State

(Send remittance by check, money order or unused U.S. Postage Stamps. Register letter if you send cash or stamps.) RC-741

OPERATES ON
110-VOLT, 60-CYCLE
A.C. LINE

WE SHIP ELECTRIC DRY
SHAVER THE SAME DAY
YOUR SUBSCRIPTION
ORDER IS RECEIVED.

CLIP COUPON—
AND MAIL!

Where to Buy It! —

CLASSIFIED RADIO DIRECTORY

Handy Buying Guide, by Products and Manufacturers' Names and Addresses, for the Entire Radio Industry

There is no charge for regular light-face listings in the Classified Radio Directory. However, if dominant bold-face listings are desired, we make a charge of \$2 for concern names and \$1 for trade names for each bold-face listing. Please write to the Advertising Dept., Radio-Craft, 20 Vesey St., New York, N. Y., for details.

This DIRECTORY is published in sections—1 section per month. This method of publication permits the DIRECTORY to be constantly up-to-date since necessary revisions and corrections can be made monthly. All names preceded by an asterisk (*) indicate that they are trade names.

If you cannot find any item or manufacturer in this section or in previously-published sections, just drop us a line for the information. Canadian radio manufacturers are unable to purchase any merchandise from the States, Radio-Craft is advised. Our readers, however, may wish to make Canadian purchases, and hence, current listings are being continued.

Presented here is Section IV of the completely revised Second Edition of the CLASSIFIED RADIO DIRECTORY.

While every precaution is taken to insure accuracy, Radio-Craft cannot guarantee against the possibility of occasional errors and omissions in the preparation of this Classified Directory. Manufacturers and readers are urged to report all errors and omissions at the earliest moment to insure corrections in the very next issue.

POWER SUPPLIES (A.C. and/or D.C.)

(Also see Batteries [& Cells] Dry & Wet [Storage])



- A.C. regulated AR
- Converters C
- Dynamotors D
- Gas-engine GE
- Generators G
- Generators, hand-driven HG
- Inverters, electronic IN
- Metallic (dry-disc) rectifiers MP
- Miniature generators & motors M
- Motor generators MG
- Power-packs (battery) for portables PB
- Power-packs (lightline) for portables PP
- Power-packs (6 V. to high voltage) for neon tubes PV
- Tube-type TP
- Vibrator V
- Wind-driven W

- *AC—National Company, Inc.
- AIR-ELECTRIC MACHINE CO., INC., Lohrville, Iowa—G, PB
- *AIRLINE—Montgomery Ward & Co., Inc.
- ALLIANCE MANUFACTURING CO., Lake Park Blvd., Alliance, Ohio—M
- ALLIED RADIO CORP., 833 W. Jackson Blvd., Chicago, Ill., *"Knight"—C, D, GE, G, MP-TP, PB, PP, TP, W
- AMERICAN COMMUNICATIONS CORP., 123 Liberty St., New York, N. Y.—TP
- AMERICAN TELEVISION & RADIO CO., 300 E. 4th St., St. Paul, Minn.—C, D, G, MP, MP-TP, PB, PP, V
- AMPLIFIER CO. OF AMERICA, 17 W. 20th St., New York, N. Y.—TP
- ARLAVOX MANUFACTURING CO., 430 S. Green St., Chicago, Ill.—TP
- AUDIO DEVELOPMENT CO., 123 Bryant Ave. N., Minneapolis, Minn.—TP
- THE BENWOOD-LINZE CO., 1870 Washington Ave., St. Louis, Mo.—MP, PB, PP, TP
- BOND ELECTRIC CORP., Div. of Western Cartridge Co., 275 Winchester Ave., New Haven, Conn.—PB
- BRIGHT STAR BATTERY CO., 200 Crooks Ave., Clifton, N. J., *"Bright Star," "Unedit," "Eclipse," "Mars"—PB, PP
- *BRIGHT STAR—Bright Star Battery Co.
- BURGESS BATTERY CO., Freeport, Ill.—PB
- CANADIAN MARCONI CO., 211 St. Sacrament St., Montreal, Can.—C, D, GE, G, PB, TP, V
- CANADIAN RADIO CORP., LTD., 622 Fleet St., W., Toronto, Ont., Can.—PB
- CARTER MOTOR CO., 1608 Milwaukee Ave., Chicago, Ill.—C, D, G
- *CO-RECT—Electronic Sound & Music Co.
- THE CROSLY CORPORATION, Cincinnati, Ohio—PB
- CRUMPACKER DISTRIB. CORP., 1801 Fannin St., Houston, Tex.—C, D, GE, G, PB, V, W

- HAROLD DAVIS, INC., 428 W. Capitol St., Jackson, Miss.—C, D, GE, G, V, W
- DOW RADIO SUPPLY CO., 1759 E. Colorado, Pasadena, Calif.—C, D, PB, V
- *ECLIPSE—Bright Star Battery Co.
- EICOR, INC., 515 S. Laflin St., Chicago, Ill.—C, D, GE, G, W
- ELECTRONIC CONTROL CORP., 2667 East Grand Blvd., Detroit, Mich.—C, TP
- ELECTRONIC LABS., INC., 122 W. New York St., Indianapolis, Ind.—C, TP, V
- ELECTRONIC PRODUCTS CO., St. Charles, Ill.—TP
- ELECTRONIC SOUND & MUSIC CO., 10 Stuyvesant St., New York, N. Y., *"Co-Rect"—C
- ELECTRO PRODUCTS LABS., 549 W. Randolph St., Chicago, Ill.—MP, MP-TP, PP, TP
- FEDERAL TELEGRAPH CO., 200 Mt. Pleasant Ave., Newark, N. J.—TP
- FEDERATED PURCHASER, INC., 80 Park Place, New York, N. Y.—C, D, GE, G, PB, PP, TP, V, W
- FISCHER DISTRIB. CORP., 222 Fulton St., New York, N. Y.—C, D, GE, G, PB, V, W
- FONDA CORPORATION, 29 W. 57th St., New York, N. Y.—D
- GENERAL DRY BATTERIES, INC., 13000 Athens Ave., Cleveland, Ohio—PB
- GENERAL ELECTRIC CO., Schenectady, N. Y. & Bridgeport, Conn.—C, D, G, TP
- GENERAL TRANSFORMER CORP., 1250 W. Van Buren St., Chicago, Ill.—MP, PP, TP
- GLOBE PHONE MANUFACTURING CORP., Reading, Mass.—PB
- GOLDENTONE RADIO CO., 15123 Warren Ave., Dearborn, Mich.—PB
- GUIDED RADIO CORP., 118 E. 25th St., New York, N. Y.—TP
- ROBERT M. HADLEY CO., 709 E. 61st St., Los Angeles, Calif.—TP
- HAMMOND MANUFACTURING CO., 40 Wellington St., W., Guelph, Ont., Can.—MP-TP
- HARRISON RADIO CO., 12 W. Broadway, New York, N. Y.—C, D, GE, PB, PP, TP, V
- HARTMAN ELECTRICAL MFG. CO., Mansfield, Ohio—PP, TP
- HARVEY WELLS COMMUNICATIONS, INC., North St., Southbridge, Mass.—TP
- HEINTZ & KAUFMAN, LTD., S. San Francisco, Calif.—GE, HG
- HILET ENGINEERING CO., 34 S. Park Dr., W. Orange, N. J.—TP
- HERBERT H. HORN, 1201 S. Olive St., Los Angeles, Calif.—PB
- INTERNATIONAL TRANSFORMER CO., 17 W. 20th St., New York, N. Y.—AR, IN
- JANETTE MANUFACTURING CO., 556 W. Monroe St., Chicago, Ill.—C, D, G, MG
- KATO ENGINEERING CO., INC., 530 N. Front St., Mankato, Minn.—C, GE, G
- KELLOGG SWITCHBOARD & SUPPLY CO., 6650 S. Cicero Ave., Chicago, Ill.—C, GE, PB, TP
- *KNIGHT—Allied Radio Corp.
- LAFAYETTE RADIO CORP., 100 6th Ave., New York, N. Y.—C, GE, G, PB, TP, V, W
- LeJAY MANUFACTURING CO., 1406 W. Lake St., Minneapolis, Minn.—GE, G, PB, PP
- FRED M. LINK, 125 W. 17th St., New York, N. Y.—V
- M. & G. HEARING AIDS CO., 30 N. Michigan Ave., Chicago, Ill.—PB
- M & H SPORTING GOODS CO., 512 Market St., Phila., Pa.—PB
- MAC-ADAMS EQUIPMENT CO., INC., 507 W. 56th St., New York, N. Y.—V
- P. R. MALLORY & CO., INC., 3029 E. Washington St., Indianapolis, Ind.—V
- *MARS—Bright Star Battery Co.
- MELLAPHONE CORPORATION, 65 Atlantic Ave., Rochester, N. Y.—TP
- MILES REPRODUCER CO., INC., 812 Broadway, New York, N. Y.—TP

- JAMES MILLEN MFG. CO., INC., 150 Exchange St., Malden, Mass.—TP
- MONTGOMERY WARD & CO., INC., 619 W. Chicago Ave., Chicago, Ill., *"Airline"—C, D, G, MP-TP, PB, PP, TP, W
- MUSIC MASTER MFG. CO., 508 S. Dearborn St., Chicago, Ill.—TP
- NATIONAL CARBON CO., INC., 30 E. 42nd St., New York, N. Y.—PB
- NATIONAL COMPANY, INC., 61 Sherman St., Malden, Mass., *"National," "AC"—BP, MP-TP, PP, TP, V
- *NATIONAL—National Company, Inc.
- NATIONAL UNION RADIO CORP., 57 State St., Newark, N. J.—PB
- NORTHERN ELECTRIC CO., LTD., 1261 Shearer St., Montreal, Que., Can.—C, D, G, PB, V
- OFFENBACH ELECTRIC CO., 1452 Market St., San Francisco, Calif.—C, GE, PB, TP, V
- OHIO CRANKSHAFT CO., Tocco Div., 6600 Clement Ave., Cleveland, Ohio—C
- *ONAN—D. W. Onan & Sons
- D. W. ONAN & SONS, 43 Royalston Ave., Minneapolis, Minn., *"Onan"—D, GE
- PHILCO RADIO & TELEVISION CORP., Tioga & "C" Sts., Phila., Pa.—PB
- PIONEER GEN-E-MOTOR CORP., 466 W. Superior St., Chicago, Ill.—C, D, GE, G
- RADIO ELECTRIC SERVICE CO., INC., N.W. Cor. 7th & Arch Sts., Phila., Pa.—C, D, GE, G, PB, TP, V, W
- RADIO EQUIPMENT CORP., 326 Elm St. Buffalo, N. Y.—C, D, GE, G, PB, TP, V
- RADIO RECEPTOR CO., INC., 251 W. 19th St., New York, N. Y.—TP
- RADOLEK COMPANY, 601 W. Randolph St., Chicago, Ill.—C, GE, PB, PP, TP
- RAY-O-VAC COMPANY, Madison, Wis.—PB
- RAYTHEON MANUFACTURING CO., 190 Willow St., Waltham, Mass.—TP
- STANDARD TRANSFORMER CORP., 1500 N. Halsted St., Chicago, Ill.—TP
- MAURICE SCHWARTZ & SON, 710-712 Broadway, Schenectady, N. Y.—C, D, GE, G, PB, TP, V, W
- SEATTLE RADIO SUPPLY CO., INC., 2117 2nd Ave., Seattle, Wash.—C, D, GE, PB, PP, TP, V
- SENTINEL RADIO CORP., 2020 Ridge Ave., Evanston, Ill.—PB
- SHELLEY RADIO CO., 1841 S. Flower St., Los Angeles, Calif.—GE, PB, V
- S.O.S. CINEMA SUPPLY CORP., 636 11th Ave., New York, N. Y.—TP
- SUN RADIO CO., 212 Fulton St., New York, N. Y.—C, D, GE, G, PB, TP, V, W
- TAYLOR AIRPHONE PRODUCTS, Hangar 15th, Long Beach Airport, Long Beach, Calif.—W
- TECHNICAL PRODUCTS INTERNATIONAL, 135 Liberty St., New York, N. Y.—C, D, GE, G, W
- *UNEEDIT—Bright Star Battery Co.
- VICTOR ANIMATOGRAPH CORP., Davenport, Iowa—C, V
- WESTINGHOUSE ELEC. & MFG. CO., East Pittsburgh, Pa.—C, G, MP
- WILCOX ELECTRIC CO., INC., 40th & State Line, Kansas City, Mo.—V
- WILLARD STORAGE BATTERY CO., 246 E. 131st St., Cleveland, Ohio—PB, PP
- WINCHARGER CORPORATION, Sioux City, Iowa—G, W

PUBLIC ADDRESS See Amplifiers; Loudspeakers (& parts); Microphones (& accessories); Sound Systems (& accessories)

Please say you saw it in the Radio-Craft "Classified Radio Directory"

• CLASSIFIED RADIO DIRECTORY •

RADIO LOGS, MAPS & GLOBES



- Amateur station logs A
- Geographical globes G
- OSL & SWL card albums CA
- Radio logs R
- Radio-set globes RG
- Shortwave charts S
- Watches (sweep-second for program timing, non-magnetic for Servicemen, etc.) W
- World time clocks WC
- World's-tour maps WM

*AC—National Company, Inc.
ALLIED RADIO CORP., 833 W. Jackson Blvd., Chicago, Ill., *"Knight"—A, G, CA, R, RG, S, WC, WM
THE GEORGE F. CRAM CO., INC., 730 E. Washington, Indianapolis, Ind.—A, G, R, RG, WM
FEDERATED PURCHASER, INC., 80 Park Pl., New York, N. Y.—A, G, CA, R, RG, S, WC, WM
GORDON SPECIALTIES CO., 1104 S. Wabash Ave., Chicago, Ill.—CA, WC
CARL GORR PRINTING CO., 1801 W. Byron St., Chicago, Ill.—A, G, R, RG, S, WM
HAYNES' RADIO LOG, P. O. Box 444, Park Ridge, Ill.—A, R, S, WM
 *KNIGHT—Allied Radio Corp.
LAFAYETTE RADIO CORP., 100 6th Ave., New York, N. Y.—A, G, CA, R, RG, S, WC, WM
NATIONAL COMPANY, INC., 61 Sherman St., Malden, Mass., *"National," "AC"—A, CA, R, S, WM
 *NATIONAL—National Company, Inc.
PIERCE WATCH CO., INC., 22 W. 48th St., New York, N. Y.—W
RCA MANUFACTURING CO., INC., Camden, N. J.—A, WM
ROGERS-MAJESTIC CORP. LTD., 622 Fleet St., Toronto, Can.—R, S, WM
SUN RADIO CO., 212 Fulton St., New York, N. Y.—A, G, CA, R, RG, S, WC, WM
WEBER COSTELLO CO., 12th & McKinley, Chicago Heights, Ill.—G, R, S, WM

RECEIVING SETS (INCLUDING ADAPTERS & CONVERTERS)

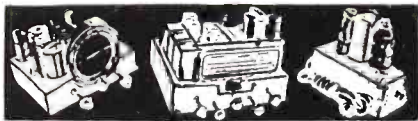

- All-wave (see "Multiple-band," below)
- Amateur (ham-radio communications) A
- Auto-radio AU
- Aviation AV
- Battery (home) B
- Battery (portable) BA
- Coin meters for radio receivers CM
- Commercial C
- Custom-built (see Custom Construction)
- Crystal CR
- Direction finders D
- Direction finders (aircraft) DA
- Facsimile F
- Farm FA
- Frequency Modulation (sets and/or adapters) FM
- High-fidelity HF
- F.M./A.M. Combinations AF
- Home H
- Kits KI
- Loop adapters LA
- Loop converters LC
- Loop receivers LR
- Marine MA
- Multiple-band MB
- Phonograph PH
- Phonograph - Radio PR

- Police P
- Police-auto PO
- Preamplifiers (R.F. boosters) PA
- Radio - Recorder combinations RR
- Shortwave S
- Shortwave adapters SA
- Shortwave converters SC
- Shortwave converters, auto-radio SW
- Television TE
- Tuners TU
- Ultra-high frequency UH

ABC RADIO LABS., 3334 W. New Jersey St., Indianapolis, Ind.—SW
 *AC—National Company, Inc.
 *AIRLINE—Montgomery Ward & Co., Inc.
ALLIED RADIO CORP., 833 W. Jackson Blvd., Chicago, Ill., *"Knight"—A, AU, B, BA, C, FA, FM, H, KI, LA, LR, MA, MB, PR, S, SA, SC
AMERICAN COMMUNICATIONS CORP., 123 Liberty St., New York, N. Y.—C, MA, PR, P, PO
AMERICAN LEADER PRODUCTS CO., 8450 S. Ashland, Chicago, Ill.—CR
AMERICAN TELEVISION CORP., 130 W. 56th St., New York, N. Y.—TE
ANSLEY RADIO CORP., 4377 Bronx Blvd., New York, N. Y., *"Dynaphone," "Dynatone"—D, FM, PR
 *ARVIN—Noblitt-Sparks Industries, Inc.
 *AUTOCRAT—Autocrat Radio Co.
AUTOCRAT RADIO CO., 3855 N. Hamilton Ave., Chicago, Ill., *"Autocrat"—B, BA, FA, H, MB, PR
AUTOMATIC RADIO MFG. CO., INC., 122 Brookline Ave., Boston, Mass.—AU, B, BA, H, LR, MB, PR, S
BARBER & HOWARD, INC., East Ave., Westerly, R. I.—AV, C, FM, H, KI, MA, MB, PR, P
BARKER & WILLIAMSON, Ardmore, Pa.—A, AV, C, MA, P, PO, S, SC, UH
REX BASSETT, INC., 214 Star Bldg., Niles, Mich.—AV, MA, P, PO, UH
BELMONT RADIO CORP., 1257 Fullerton Ave., Chicago, Ill.—AU, B, BA, FA, H, MB, PR
BENDIX RADIO CORP., 920 E. Fort Ave., Baltimore, Md.—AV, DA, LR
DAVID BOGEN CO., 663 Broadway, New York, N. Y.—TU
BOND PRODUCTS CO., 13139 Hamilton Ave., Detroit, Mich.—BA, HM, MB, PR
BRETING RADIO MFG. CO., 1815 Venice Blvd., Los Angeles, Calif.—A, AV
BROWNING LABORATORIES, INC., 750 Main St., Winchester, Mass.—A, FM, KI, MB, PO, SA, SC, UH
CALVERT MOTORS ASSOCIATES, LTD., 1028 Linden Ave., Baltimore, Md.—AU, BA, H
CANADIAN MARCONI CO., 211 St. Sacramento St., Montreal, Can.—A, AU, AV, B, BA, C, F, FA, FM, MA, MB, PR, P, PO, S, SA, SC, TE, UH
CANADIAN RADIO CORP., LTD., 622 Fleet St., W. Toronto, Ont., Can.—AU, B, BA, FA, H, LR, MB, PR
CANTON TRADING CO., 135 Liberty St., New York, N. Y.—PR
CARRON MANUFACTURING CO., 415 S. Aberdeen St., Chicago, Ill.—KI
CONTINENTAL RADIO & TELEVISION CORP., 3800 Cortland St., Chicago, Ill.—B, BA, FA, H, MB, PR, RR, S
THE CROSLY CORPORATION, Cincinnati, Ohio—FA, PR
CRUMPACKER DISTRIB. CORP., 1801 Fannin St., Houston, Tex.—AU, AV, B, BA, FA, PR, P, PO
HAROLD DAVIS, INC., 428 W. Capitol St., Jackson, Miss.—A, FM
 *DEWALD—DeWald Radio Mfg. Corp.
DeWALD RADIO MFG. CORP., 440 Lafayette St., New York, N. Y., *"DeWald"—AU, B, BA, FA
DOOLITTLE RADIO, INC., 7421 Loomis Blvd., Chicago, Ill.—P, PO
DOW RADIO SUPPLY CO., 1759 E. Colorado St., Pasadena, Calif.—A, AU, B, BA, C, H, MB, PR, PO, S
 *DYNAPHONE—Ansley Radio Corp.
 *DYNATONE—Ansley Radio Corp.
E. A. ECKSTEIN COMPANY, LeRoy, Minn.—B, FA
ESPEY MFG. CO., INC., 305 E. 63rd St., New York, N. Y.—BA, FM, H, LR, MA, MB, PR, TE
FARNSWORTH TELEVISION RADIO CORP., 3700 E. Pontiac St., Ft. Wayne, Ind.—FM, H, PR, TE
FEDERAL TELEGRAPH CO., 200 Mt. Pleasant Ave., Newark, N. J.—MA
FEDERATED PURCHASER, INC., 80 Park Pl., New York, N. Y.—A, AU, B, BA, C, FA, FM, H, KI, MB, PR, S, UH
FERGUSON RADIO, INC., 14553 Madison Ave., Lakewood, Ohio—H, KI, MB, PR, S
FINCH TELECOMMUNICATIONS, INC., 1919 Broadway, New York, N. Y.—F
FISHER RESEARCH LAB., 1961 University Ave., Palo Alto, Calif.—A, AV, C, FM, LA, LC, LR, MA, MB, P, PO, UH
FREED RADIO CORP., 39 W. 19th St., New York, N. Y.—FM

GALVIN MANUFACTURING CORP., 4545 W. Augusta Blvd., Chicago, Ill., *"Motorola"—AU, AV, B, BA, FA, FM, H, LR, MB, PR, P, PO, S, UH
GAROD RADIO CORP., 70 Washington St., Brooklyn, N. Y.—BA, H, LR, MA, MB, PR, S
GENERAL ELECTRIC CO., Schenectady, N. Y., & Bridgeport, Conn.—AU, B, BA, FA, FM, H, PR, P, PO, TE
GOLDENTONE RADIO CO., 15123 Warren Ave., Dearborn, Mich.—B, BA, FA, H, MB, PR
THE HALLICRAFTERS, INC., 2611 Indiana Ave., Chicago, Ill.—A, C, FM, H, LR, MA, MB, S, UH
HAMMARLUND MFG. CO., INC., 424 W. 33rd St., New York, N. Y.—A, AV, C, MB, S
HARRISON RADIO CO., 12 W. Broadway, New York, N. Y.—A, AV, BA, C, FM, KI, MA, MB, S, UH
HARVEY-WELLS COMMUNICATIONS, INC., North St., Southbridge, Mass.—AV, BA, FM, MA, P, PO, S, UH
HETRO ELECTRICAL INDUSTRIES, INC., 5819 N. Drake Ave., Chicago, Ill., *"Hetro"—AU, B, BA, FA, H, MB, PR, S
 *HETRO—Hetro Electrical Industries, Inc.
HOWARD RADIO CO., 1731 W. Belmont Ave., Chicago, Ill.—A, AV, B, BA, C, FA, FM, H, LA, LC, LR, MA, MB, PR, P, PO, PA, S, SA, SC, UH
RAY JEFFERSON, INC., 182 Milburn Ave., Baldwin, N. Y., *"Mansley"—LR, MA, P, PO
KAAR ENGINEERING CO., 619 Emerson St., Palo Alto, Calif.—AV, MA, P, PO
KADETTE RADIO CORP., 200 Hill St., Ann Arbor, Mich.—BA, H, PR
KARNS-WHITE CORPORATION, 1775 Broadway, New York, N. Y.—B, BA, C, FA, LR, MA, P
KINGSTON RADIO CO., INC., Kokomo, Ind.—B, FA, H, LR, PR, S
 *KNIGHT—Allied Radio Corp.
LAFAYETTE RADIO CORP., 100 6th Ave., New York, N. Y.—A, AU, AV, B, BA, C, FA, FM, H, KI, LR, MA, MB, PR, S, SA, SC, UH
LAUREHK RADIO MFG. CO., 3918 Monroe Ave., Wayne, Mich.—BA
 *LEARADIO—Lear Avia, Inc.
LEAR AVIA, INC., 30 Rockefeller Plaza, New York, N. Y., *"Learadio"—AV, BA, D, S (aircraft), UH (aircraft)
FRED M. LINK, 125 W. 17th St., New York, N. Y.—P, PO, UH
MAC-ADAMS EQUIPMENT CO., INC., 507 W. 56th St., New York, N. Y.—AU, FM, H, TE
MAJESTIC RADIO & TELEVISION CORP., 2600 W. 50th St., Chicago, Ill.—B, BA, FA, FM, H, MB, PR, P, PO, S
 *MANSLEY—Ray Jefferson, Inc.
MARINEPHONE, INC., 123 Liberty St., New York, N. Y.—D, MA
MARINE RADIO CORP., 117-19 168th St., Jamaica, N. Y.—A, AU, AV, C, D, FM, MA, MB, P, PO, S
 *MARK-TIME—M. H. Rhodes, Inc.
MEISSNER MANUFACTURING CO., Mt. Carmel, Ill.—A, AV, B, BA, C, FM, H, KI, MB, PR, S, TE, UH
 *MIDWEST—Midwest Radio Corp.
MIDWEST RADIO CORP., 909 Broadway, Cincinnati, Ohio, *"Midwest"—A, H, MB
JAMES MILLEN MFG. CO., INC., 150 Exchange St., Malden, Mass.—C
J. W. MILLER COMPANY, 5917 S. Main St., Los Angeles, Calif., *"Miller Quality Products," "Miller"—KI
 *MILLER—J. W. Miller Company
 *MILLER QUALITY PRODUCTS—J. W. Miller Company
MISSION BELL RADIO MFG. CO., INC., 831 Venice Blvd., Los Angeles, Calif.—AV, BA, FM, H, PR, P, PO, S, TE
MONTGOMERY & CO., INC., 619 W. Chicago Ave., Chicago, Ill., *"Airline"—A, AU, B, BA, FA
 *MOTOROLA—Galvin Manufacturing Corp.
MUSIC MASTER MFG. CO., 508 S. Dearborn St., Chicago, Ill.—A, KI, PR, S
NATIONAL COMPANY, INC., 61 Sherman St., Malden, Mass., *"National," "AC"—A, AV, B, BA, C, FM, H, MA, MB, P, S, UH
 *NATIONAL—National Company, Inc.
NATIONAL UNION RADIO CORP., 57 State St., Newark, N. J.—BA, H
NOBLITT-SPARKS INDUSTRIES, INC., Columbus, Ind., *"Arvin"—AU, BA, H, LR, PR
NORTHERN ELECTRIC CO., LTD., 1261 Shearer St., Montreal, Que., Can.—AV, B, BA, C, FA, H, MB, P, PO, S
OFFENBACH ELECTRIC CO., 1452 Market St., San Francisco, Calif.—A, BA, C, H, KI, LR, MA, MB, PR, S, UH
PACENT ENGINEERING CORP., 79 Madison Ave., New York, N. Y.—FM, HF, H, PR, UH
PHILCO RADIO & TELEVISION CORP., Tioga & "C" Sts., Phila., Pa.—AU, B, BA, FA, H, LA, LR, MB, PR, P, PO, S
PHILHARMONIC RADIO CO., 21 W. 45th St., New York, N. Y.—PR
PHILMORE MFG. CO., INC., 113 University Pl., New York, N. Y.—B, BA, H, KI, LA, S
PIERSON-DELANE, INC., 2345 W. Washington Blvd., Los Angeles, Calif.—A, AV, BA, C, MB, P, PO, S, UH

Please say you saw it in the Radio-Craft "Classified Radio Directory"

CLASSIFIED RADIO DIRECTORY

PILOT RADIO CORP., 37-06 36th St., L. I. City, N. Y.—B, BA, FA, FM, H, MB, PR, S
RADIO ELECTRIC SERVICE CO., INC., N.W.
 Cor. 7th & Arch Sts., Phila., Pa.—A, AU, B, BA, FA, FM, H, KI, MA, MB, PR, P, S, TE, UH
RADIO EQUIPMENT CORP., 326 Elm St., Buffalo, N. Y.—A, AU, B, BA, C, FA, H, KI, LR, MA, MB, PR, S, UH
RADIO MFG. ENGINEERS, INC., 111 Harrison St., Peoria, Ill.—A, AV, BA, C, MA, MB, P, S, SC, UH
RADIO NAVIGATIONAL INSTRUMENT CORP., 500 5th Ave., New York, N. Y.—AV, DA, LR, MA
RADIO TRANSCIEVER LABS., 8627 115th St., Richmond Hill, N. Y.—S, UH
RADOLEK COMPANY, 601 W. Randolph St., Chicago, Ill.—A, AU, AV, B, BA, C, F, FA, FM, H, KI, LA, LC, LR, MB, PR, S, SA, SC, UH
RCA MANUFACTURING CO., INC., Camden, N. J.—A, AU, AV, B, BA, C, F, FA, H, MA, MB, PR, P, PO, S, TE, UH
 *RECORDIO—Wilcox-Gay Corporation
REGAL AMPLIFIER MFG. CORP., 14 W. 17th St., New York, N. Y.—PH
M. H. RHODES, INC., 30 Bartholomew Ave., Hartford, Conn.—*Mark-Time—CM
ROGERS-MAJESTIC CORP., LTD., 622 Fleet St., Toronto, Can.—B, BA, FA, H, LR, MB, PR, P, S
ROWE INDUSTRIES, INC., 3120 Monroe St., Toledo, Ohio—AV
MAURICE SCHWARTZ & SON, 710-712 Broadway, Schenectady, N. Y.—A, AU, AV, B, BA, C, F, FA, FM, H, KI, LA, LC, LR, MA, MB, PR, P, PO, S, SA, SC, TE, UH
E. H. SCOTT RADIO LABS., INC., 4450 Ravenswood Ave., Chicago, Ill.—A, FM, H, MB, PR
SEATTLE RADIO SUPPLY CO., INC., 2117 2nd Ave., Seattle, Wash.—B, BA, C, FA, FM, H, KI, LR, MA, MB, PR, P, PO, S, UH
SENTINEL RADIO CORP., 2020 Ridge Ave., Evanston, Ill.—B, BA, FA, H, MB, PR, S
SETCHELL CARLSON, INC., 2233 University Ave., St. Paul, Minn.—AU, AV, B, BA, FA, FM, H, MA, MB, P, PO, S, UH
SHELLEY RADIO CO., 1841 S. Flower St., Los Angeles, Calif.—A, AU, B, BA, C, MA, MB, PR
SKY CHIEF RADIO CORP., 345 E. 27th St., New York, N. Y.—B, BA, C, F, H, PR
SONORA RADIO & TELEVISION CORP., 2626 W. Washington Blvd., Chicago, Ill.—AU, B, BA, H, PR
STEWART-WARNER-ALEMITE CORP. OF CANADA, LTD., Belleville, Ont., Can.—AU, AV, B, BA, FA, H, MA, MB, PR
STEWART-WARNER CORP., 1826 Diversey Pkwy., Chicago, Ill.—B, BA, FA, FM, H, MB, PR, S
STROMBERG-CARLSON TELEPHONE MFG. CO., 100 Carlson Rd., Rochester, N. Y.—BA, FM, H, MB, PR, TE
SUN RADIO CO., 212 Fulton St., New York, N. Y.—A, AU, B, BA, C, F, FA, FM, H, KI, LA, LC, LR, MA, MB, PR, S, SA, SC, TE, UH
TAY BERN EQUIPMENT CO., INC., 135 Liberty St., New York, N. Y.—AV, C, MA, P, PO, UH
TAYLOR AIRPHONE PRODUCTS, INC., Long Beach Municipal Airport, Long Beach, Calif.—AV, C
TRAV-LER RADIO & TELEVISION CORP., 1036 Van Buren, Chicago, Ill.—AU, B, BA, FA, H, MB, PR, S
TREBOR RADIO CO., Pasadena, Calif.—H
TROY RADIO & TELEVISION CO., 1144 S. Olive St., Los Angeles, Calif.—AV, B, BA, FA, H, MB, PR, S, TE
UNITED STATES TELEVISION MFG. CORP., 220 E. 51st St., New York, N. Y.—TE
THE VOGUE COMPANY, 8134 Vincennes Ave., Chicago, Ill.—CR
VICTOR ANIMATOGRAPH CORP., Davenport, Iowa—PR
WARWICK MANUFACTURING CORP., 1700 W. Washington Blvd., Chicago, Ill.—AU, B, BA, FA, H, PR, S
WELLS GARDNER & CO., 2701 W. Kildare Ave., Chicago, Ill.—A, AU, B, BA, FA, PR, S
WESTERN ELECTRIC CO., INC., 300 Central Ave., Kearney, N. J.—MA, P, PO
WESTINGHOUSE ELEC. SUPPLY CO., 150 Varick St., New York, N. Y.—H, PR
WILCOX ELECTRIC CO., 40th & State Line, Kansas City, Mo.—AV, F, FM, MA, P, PO, UH
WILCOX-GAY CORPORATION, Charlotte, Mich.—*Recordio—B, BA, H, PR, P

Cutting heads, vertical (hill-and-dale) CV
 Cutting heads, lateral & vertical (combined) CC
 Cuttings remover CU
 Discs (blank) DB
 Envelopes EN
 Equalizers EQ
 Film (blank for indenting) FI
 Film (blank for photographing) FP
 Lead screws LS
 Magnetic-tape recorders MR
 Monitor meters MM
 Needles NE
 Pickups (see Records & Recording Equipment)
 Playback demonstrators (booths, counters, etc.) PD
 Portable disc recorders PR
 Recording machine assemblies (cutter, pickup, motor, turntable) RE
 Recording supplies (record preservers, etc.) RU
 Sound-effects kits SK
 Sound-on-disc (for talking pictures) SD
 Sound-on-film recorders (indenting) SI
 Transcription equipment TR

ACOUSTIC EQUIPMENT CO., 323 Walton Bldg., Atlanta, Ga.—TR
 H. W. ACTON CO., INC., 370 7th Ave., New York, N. Y.—NE
 *AIRLINE—Montgomery Ward & Co., Inc.
 ALLIANCE MANUFACTURING CO., Lake Park Blvd., Alliance, Ohio—RE
ALLIED RADIO CORP., 833 W. Jackson Blvd., Chicago, Ill.—*Knight—CA, CR, CL, DB, EQ, NE, RE, RU, TR
 AMPLIFIER CO. OF AMERICA, 17 W. 20th St., New York, N. Y.—EQ, TR
THE ASTATIC CORPORATION, 830 Market St., Youngstown, Ohio—CL, NE, RE
 AUDAK COMPANY, 500 5th Ave., New York, N. Y.—*Microdyne—CL
 AUDIO DEVICES, INC., 1600 Broadway, New York, N. Y.—CU, DB, EQ, NE, SK
 AUDIOGRAPH SOUND SYSTEMS, 1313 W. Randolph St., Chicago, Ill.—CA, CR, CL, TR
 *AUTOCRAT—Autocrat Radio Co.
 AUTOCRAT RADIO CO., 3855 N. Hamilton Ave., Chicago, Ill.—*Autocrat—CR, DB, RE
 BANK'S MANUFACTURING CO., 5019 N. Winthrop Ave., Chicago, Ill.—CA, CR
 BELL SOUND SYSTEMS, INC., 1183 Essex Ave., Columbus, Ohio—PR
 A. BITTER CONSTRUCTION CORP., 27-01 Bridge Pl. N., Long Island City, N. Y.—PD
 DAVID BOGEN CO., INC., 663 Broadway, New York, N. Y.—CA, DB, NE
 THE BRUSH DEVELOPMENT CO., 3311-3405 Perkins Ave., Cleveland, Ohio—CL
 CANADIAN MARCONI CO., 211 St. Sacrament St., Montreal, Can.—CR, CL, CV, DB, EQ, RE, TR
 CARBIDE & CARBON CHEMICALS CORP., 30 E. 42nd St., New York, N. Y.—DB
 CARRON MANUFACTURING CO., 415 S. Aberdeen St., Chicago, Ill.—DB, NE
 CHICAGO SOUND SYSTEMS CO., 315 E. Grand Ave., Chicago, Ill.—CA
 COMMUNICATIONS, INC., 3215 Western Ave., Seattle, Wash.—*Commun-O-Phone, *Incriminator, *Electro-Phone—MR
 *COMMUN-O-PHONE—Communications, Inc.
 *CO-RECHT—Electronic Sound & Music Co.
 THE CROSLY CORPORATION, Cincinnati, Ohio—CA, CR
 CRUMPACKER DISTRIBUTOR, 1801 Fannin St., Houston, Tex.—CA, CR, DB, NE
 THE DAVEN COMPANY, 158 Summit St., Newark, N. J.—EQ
 HAROLD DAVIS, INC., 428 W. Capitol St., Jackson, Miss.—CA, CR, CL, CV, DB, NE, RE, RU, TR
 DEVRY CORPORATION, 1111 Armitage Ave., Chicago, Ill.—CA
 *DICTAFILM—Miles Reproducer Co., Inc.
 DOW RADIO SUPPLY CO., 1759 E. Colorado St., Pasadena, Calif.—CA, CR, DB, NE, RE
 DUPLEX RECORDING DEVICES CO., 1041 Manor Ave., New York, N. Y.—RE, SD, TR
 EASTMAN KODAK COMPANY, Rochester, N. Y.—FP
 ELECTRONIC APPLICATIONS, Brunswick, Maine—EQ
 ELECTRONIC SOUND & MUSIC CO., 10 Stuyvesant St., New York, N. Y.—*Co-recht—CA, CR
 *ELECTRO-PHONE—Communications, Inc.
 ESPEY MANUFACTURING CO., INC., 305 E. 63rd St., New York, N. Y.—CR

FAIRCHILD AVIATION CORP., Sound Equipment Div., 88-06 Van Wyck Blvd., Jamaica, L. I., N. Y.—CL, DB, EQ, NE, RE, TR
 FARNSWORTH TELEVISION & RADIO CORP., 3700 E. Pontiac St., Ft. Wayne, Ind.—CA, CR
 FEDERAL RECORDER CO., INC., 630 S. Wabash Ave., Chicago, Ill.—CA, CR, CL, DB, NE
FEDERAL RECORDER CO., INC., 630 S. Wabash Ave., Chicago, Ill.—CA, CR, CL, DB, NE
 *FILMGRAPH—Miles Reproducer Co., Inc.
 FISCHER DISTRIBUTING CORP., 222 Fulton St., New York, N. Y.—CA, CR, CL, CV, DB, EQ, NE, RE, RU, TR
 FONDA CORPORATION, 29 W. 57th St., New York, N. Y.—CL, EQ
 GALVIN MANUFACTURING CORP., 4545 W. Augusta Blvd., Chicago, Ill.—*Motorola—CA, DB, NE
 GENERAL CEMENT MFG. CO., 919 Taylor Ave., Rockford, Ill.—NE, RU
 GENERAL COMMUNICATION PRODUCTS CO., 6245 Lexington Ave., Hollywood, Calif.—CA, CL
 GENERAL ELECTRIC CO., Schenectady, N. Y., & Bridgeport, Conn.—CR
 M. A. GERETT CO., 2947 N. 30th St., Milwaukee, Wis.—NE
CARL GORR PRINTING CO., 1801 W. Byron St., Chicago, Ill.—DB
 HARRISON RADIO CO., 12 W. Broadway, New York, N. Y.—CA, CR, CL, DB, EQ, NE, RE, RU, TR
 HOME RECORDING CO., 54 E. 11th St., New York, N. Y.—*Home Recordio—CU
 *HOME RECORDIO—Home Recording Co.
 HERBERT H. HORN, 1201 S. Olive St., Los Angeles, Calif.—CR, DB, NE, TR
 HOWARD RADIO CO., 1731 W. Belmont Ave., Chicago, Ill.—CA, CR, DB, NE
 *INCRIMINATOR—Communications, Inc.
 INSULINE CORP. OF AMERICA, 30-30 Northern Blvd., Long Island City, N. Y.—DB, NE
 J. F. D. MANUFACTURING CO., 4111 Ft. Hamilton Pkwy., Brooklyn, N. Y.—DB, NE, RU
 *KNIGHT—Allied Radio Corp.
 LAFAYETTE RADIO CORP., 100 6th Ave., New York, N. Y.—CA, CR, CL, DB, EQ, NE, RE, RU, TR
 M & H SPORTING GOODS CO., 512 Market St., Phila., Pa.—CA, CR, CL, DB, NE, RU
 MAJESTIC RADIO & TELEVISION CORP., 2600 W. 50th St., Chicago, Ill.—CA, CR, DB
 JOHN MECK INDUSTRIES, 1313 Randolph St., Chicago, Ill.—CA, RE, TR
 MEISSNER MANUFACTURING CO., Mt. Carmel, Ill.—CA, RE
 MELLOPHONE CORPORATION, 65 Atlantic Ave., Rochester, N. Y.—CL, RE
 CHARLES MICHELSON ELECTRICAL TRANSCRIPTIONS, 67 W. 44th St., New York, N. Y.—TR
 *MICRODYNE—Audak Company
 MILES REPRODUCER CO., INC., 812 Broadway, New York, N. Y.—*Filmgraph, *Dictafilm—CA, CR, CL, FI, NE, SI
 MIRROR RECORD CORP., 58 W. 25th St., New York, N. Y.—*Mirror—DB, EN, NE, RU
MISSION BELL RADIO MFG. CO., INC., 831 Venice Blvd., Los Angeles, Calif.—CR, DB
 MONTGOMERY WARD & CO., INC., 619 W. Chicago Ave., Chicago, Ill.—*Airline—CA, CR, CL, CV, DB, NE
 *MOTOROLA—Galvin Manufacturing Corp.
 MUSIC MASTER MFG. CO., 508 S. Dearborn St., Chicago, Ill.—CA, DB, NE, TR
 NASH RADIO PRODUCTS CO., 6267 Gravois Ave., St. Louis, Mo.—RU
NATIONAL UNION RADIO CORP., 57 State St., Newark, N. J.—CA
 NORTHERN ELECTRIC CO., LTD., 1261 Shearer St., Montreal, Que., Can.—CA, RE, TR
 OFFENBACH ELECTRIC CO., 1452 Market St., San Francisco, Calif.—CL, DB, EQ, NE, RE
 PACENT ENGINEERING CORP., 79 Madison Ave., New York, N. Y.—CA, CR, TR
 PEERLESS ALBUM CO., INC., 38 W. 21st St., New York, N. Y.—DB, NE
 PHILCO RADIO & TELEVISION CORP., Tioga & "C" Sts., Phila., Pa.—CR, CL, DB, NE
 PHONOGRAPH NEEDLE MFG. CO., INC., 42-46 Dudley St., Providence, R. I.—NE
 PHONOTONE LABORATORIES, INC., S.E. 15th & State Sts., Washington, Ind.—CA, CL, DB, RE, TR
 POINSETTIA, INC., 97 Cedar Ave., Pitman, N. J.—CL, CV
PRESTO RECORDING CORP., 242 W. 55th St., New York, N. Y.—CA, CR, CL, DB, EQ, NE, RE, RF, TR
 B. A. PROCTOR COMPANY, INC., 230 Park Ave., New York, N. Y.—CA, CL, DB, RE, TR
RADIO ELECTRIC SERVICE CO., INC., N.W.
 Cor. 7th & Arch Sts., Phila., Pa.—CA, CR, CL, CB, DB, EQ, NE, RE, RU, TR
 RADIO EQUIPMENT CORP., 326 Elm St., Buffalo, N. Y.—CA, CR, DB, EQ, NE
RADIOTONE, INC., 7356 Melrose Ave., Hollywood, Calif.—CA, CR, CL, DB, EQ, NE, RE, RU, TR
 RADOLEK COMPANY, 601 W. Randolph St., Chicago, Ill.—CA, CR, CL, CV, DB, NE, RE, RU, TR

RECORDING EQUIPMENT



Chemicals (for hardening, etc.)
 (See Recording Supplies, below)
 Combination public-address & recording amplifiers CA
 Combination Radio-Recorders CR
 Cutting heads, lateral CL

Please say you saw it in the Radio-Craft "Classified Radio Directory"

CLASSIFIED RADIO DIRECTORY

RAY-LAB COMPANY, Grand Central & 11th St., Elmira Heights, N. Y., *Ray-Lab"—CA
 *RAY-LAB—Ray-lab Company
 RCA MANUFACTURING CO., INC., Camden, N. J.—CA, CR, DB, EQ, NE, RE, RU, TR
 *RECORDIO—Wilcox-Gay Corporation
 RECOTON CORPORATION, 178 Prince St., New York, N. Y.—NE
 REGAL AMPLIFIER MFG. CORP., 14 W. 17th St., New York, N. Y.—CA, TR
 REK-O-KUT CORPORATION, 173 Lafayette St., New York, N. Y.—LS, MM, RE
 *ROCKET—Shure Brothers
 ROCK-OLA MANUFACTURING CORP., 800 N. Kedzie Ave., Chicago, Ill.—CR
 ROWE INDUSTRIES, INC., 3120 Monroe St., Toledo, Ohio—CA
 MAURICE SCHWARTZ & SON, 710-712 Broadway, Schenectady, N. Y.—CA, CR, CL, CV, DB, EQ, NE, RE, RU, TR
 SEATTLE RADIO SUPPLY CO., INC., 2117 2nd Ave., Seattle, Wash.—CA, CR, CL, DB, EQ, NE, RE, RU, TR
 SELECTAR MANUFACTURING CORP., 30 W. 15th St., New York, N. Y.—CA, CL, DB, NE, RE, TR
 SENTINEL RADIO CORP., 2020 Ridge Ave., Evanston, Ill.—CR
 SHELLEY RADIO CO., 1841 S. Flower St., Los Angeles, Calif.—CR, DB, NE
 *SHURE—Shure Brothers
 SHURE BROTHERS, 225 W. Huron St., Chicago, Ill., *Shure, "Unidyne," "Uniplex," "Rocket," "Stratoliner," "Super-Level," "Ultrawide-Range," "Zephyr"—CL
 SKY CHIEF RADIO CORP., 345 E. 27th St., New York, N. Y.—CR
 S.O.S. CINEMA SUPPLY CORP., 636 11th Ave., New York, N. Y.—CA
 SOUND APPARATUS CO., 150 W. 46th St., New York, N. Y.—CA, CR, CL, CV, DB, EQ, NE, RE, RU, TR
 SPEAK-O-PHONE RECORDING & EQUIPMENT CO., 23 W. 60th St., New York, N. Y.—CA, CR, CL, DB, NE, RE, RU, TR
 *STRATOLINER—Shure Brothers
 SUN RADIO CO., 212 Fulton St., New York, N. Y.—CA, CR, CL, CV, DB, EQ, NE, RE, RU, TR
 *SUPER-LEVEL—Shure Brothers
 TALK-A-PHONE MANUFACTURING CO., 1219 W. Van Buren St., Chicago, Ill.—CA, RE
 TALKING DEVICES CO., 4447-55 Irving Park Rd., Chicago, Ill.—CL, CV, DB, RE, TR
 TALKING SALES PICTURES, INC., 317 E. Ontario St., Chicago, Ill.—TR
 THE TONOFON COMPANY, 15 E. 26 St., New York, N. Y.
 TRANSFORMER CORP. OF AMERICA, 69 Wooster St., New York, N. Y., *Clarion"—CA, EQ, NE, RE, TR
 *ULTRAWIDE-RANGE—Shure Brothers
 *UNIDYNE—Shure Brothers
 *UNIPLEX—Shure Brothers
 UNITED TRANSFORMER CORP., 150 Varick St., New York, N. Y.—CA, EQ
 UNIVERSAL MICROPHONE CO., LTD., 424 Warren Lane, Inglewood, Calif.—CL, DB, NE, RE, RU, TR
 VICTOR ANIMATOGRAPH CORP., Davenport, Iowa—CA
 WEBSTER-CHICAGO CORPORATION, 5622 W. Bloomingdale Ave., Chicago, Ill.—CL
 WEBSTER ELECTRIC CO., Clark & DeKoven Ave., Racine, Wis.—CL, NE
 WESTERN ELECTRIC CO., 300 Central Ave., Kearney, N. J.—CC
 WESTERN SOUND & ELECTRIC LABS., INC., 311 W. Kilbourn Ave., Milwaukee, Wisc.—CA, CR, CL, CV, DB, EQ, NE, RE, RU, TR
 WILCOX ELECTRIC CO., 40th & State Line, Kansas City, Mo.—EQ
 WILCOX-GAY CORPORATION, Charlotte, Mich., *Recordio"—CA, CR, DB
 *ZEPHYR—Shure Brothers

Pickup crystal cartridges PI
 Pickups (crystal) PC
 Pickups (dynamic) PD
 Pickups (magnetic) PM
 Record albums RL
 Record cabinets RB
 Record carrying cases RS
 Record player attachments RT
 Record racks RR
 Records RC
 Sound-effects records SR
 Transcription record players TP
 Turntable felt TF
 Turntables TU
 Turntables (broadcasting) TB
 Wireless players WI

H. W. ACTON CO., INC., 370 7th Ave., New York, N. Y.—NE
 *AIRLINE—Montgomery Ward & Co., Inc.
 ALLIANCE MANUFACTURING CO., Lake Park Blvd., Alliance, Ohio—MO, TU
 ALLIED RADIO CORP., 833 W. Jackson Blvd., Chicago, Ill., *Knight"—AU, EL, MO, NE, PC, PD, PM, RL, RB, RT, RC, TP, TU, WI
 ALOHA MUSICAL INSTRUMENT & PUBLISHING CO., 807 W. 79th St., Chicago, Ill.—AU, EL, RC
 ALTO MANUFACTURING CO., 1647 Wolfram St., Chicago, Ill.—FC
 AMERICAN COMMUNICATIONS CORP., 123 Liberty St., New York, N. Y.—EL
 ANSLEY RADIO CORP., 4377 Bronx Blvd., New York, N. Y., *Dynaphone," "Dynatone"—EL
 THE ASTATIC CORPORATION, 830 Market St., Youngstown, Ohio—NE, PC
 AUDAK COMPANY, 500 5th Ave., New York, N. Y., *Microdyne"—PM
 AUDIO DEVICES, INC., 1600 Broadway, New York, N. Y.—PD
 AUDIOGRAPH SOUND SYSTEMS, 1313 W. Randolph St., Chicago, Ill.—AU, EL, PC, PD, RT, TP, TU
 *AUTOCRAT—Autocrat Radio Co.
 AUTOCRAT RADIO CO., 3855 N. Hamilton Ave., Chicago, Ill., *Autocrat"—AU, EL, EP, MO, PC, RT, TU
 AUTOMATIC RADIO MFG. CO., INC., 122 Brookline Ave., Boston, Mass.—EL
 BANK'S MANUFACTURING CO., 5019 N. Winthrop Ave., Chicago, Ill.—AU, EL
 BELL SOUND SYSTEMS, INC., 1183 Essex Ave., Columbus, Ohio—AU, EL, TP, TU
 A. BITTER CONSTRUCTION CORP., 27-01 Bridge Pl. N., L. I. City, N. Y.—RB
 DAVID BOGEN CO., 663 Broadway, New York, N. Y.—AU, EL, MO, NE, PC, PM, RT, TP, TU, WI
 THE BRUSH DEVELOPMENT CO., 3311-3405 Perkins Ave., Cleveland, Ohio—PC
 BUD RADIO, INC., 5205 Cedar Ave., Cleveland, Ohio—WI
 CALVERT MOTORS ASSOCIATES, LTD., 1028 Linden Ave., Baltimore, Md.—EL, WI
 CANADIAN MARCONI CO., 211 St. Sacramento St., Montreal, Can.—AU, EL, MO, NE, PC, PD, PM, TP, TU
 CANTON TRADING CO., 135 Liberty St., New York, N. Y.—EL, RL, RT, WI
 CARRON MANUFACTURING CO., 415 S. Aberdeen St., Chicago, Ill.—EL, MO, NE, PC, PM, RC, WI
 CHICAGO SOUND SYSTEMS CO., 315 E. Grand Ave., Chicago, Ill.—AU, CP
 CLARK PHONOGRAPH RECORD CO., 216 High St., Newark, N. J.—RC
 COMMUNICATIONS, INC., 3215 Western Ave., Seattle, Wash., *Commun-O-Phone," "Incriminator," "Electro-Phone"—CP
 *COMMUN-O-PHONE—Communications, Inc.
 CONTINENTAL RADIO & TELEVISION CORP., 3800 Cortland St., Chicago, Ill.—WI
 *CO-RECHT—Electronic Sound & Music Co.
 CRACRAFT, INC., 28 Grove St., New York, N. Y.—RC
 CRUMPACKER DISTRIB. CORP., 1801 Fannin St., Houston, Tex.—NE, PC, PM, RT, RC, TP, TU, WI
 HAROLD DAVIS, INC., 428 W. Capitol St., Jackson, Miss.—AU, CP, EL, MO, NE, PC, PD, PM, RT, RC, TP, TU, WI
 DEVRY CORPORATION, 1111 Armitage Ave., Chicago, Ill.—EL
 DOW RADIO SUPPLY CO., 1759 E. Colorado St., Pasadena, Calif.—AU, MO, NE, PC, PD, PM, RT, RC, TU, WI
 DUPLEX RECORDING DEVICES CO., 1041 Manor Ave., New York, N. Y.—TP
 *DYNAPHONE—Ansley Radio Corp.
 *DYNATONE—Ansley Radio Corp.
 ELECTRONIC SOUND & MUSIC CO., 10 Stuyvesant St., New York, N. Y., *Co-recht"—EL, RT, TU, WI
 *ELECTRO-PHONE—Communications, Inc.
 ERWOOD SOUND EQUIP. CO., 224 W. Huron St., Chicago, Ill.—AU
 ESPEY MANUFACTURING CO., INC., 305 E. 63rd St., New York, N. Y.—EL, RT, TU, WI

FAIRCHILD AVIATION CORP., Sound Equipment Div., 88-6 Van Wyck Blvd., Jamaica, L. I., N. Y.—PC, TP
 FARNSWORTH TELEVISION & RADIO CORP., 3700 E. Pontiac St., Ft. Wayne, Ind.—AU, EL, RT
 FEDERAL RECORDER CO., INC., 630 S. Wash. Ave., Chicago, Ill.—NE, PC
 FEDERATED PURCHASER, INC., 80 Park Pl., New York, N. Y.—AU, EL, MO, NE, PC, PD, PM, RL, RB, RT, TP, TU, WI
 FERGUSON RADIO, INC., 14553 Madison Ave., Lakewood, Ohio—EL, RT, WI
 FISCHER DISTRIB. CORP., 222 Fulton St., New York, N. Y.—AU, EL, MO, NE, PC, PD, PM, RT, RC, TP, TU, WI
 FLOCK PROCESS CORP., 17 W. 31st St., New York, N. Y.—TU
 FONDA CORPORATION, 29 W. 57th St., New York, N. Y.—PC, PD, PM
 THE JOHN GABEL MFG. CO., 1200 W. Lake St., Chicago, Ill.—AU, CP, EL, PM
 GALVIN MANUFACTURING CORP., 4545 W. Augusta Blvd., Chicago, Ill., *Motorola"—AU, NE, WI
 GARRARD SALES CORP., 296 Broadway, New York, N. Y.—AU, EL, MO, NE, PC, PD, PM, RB, RT, TP, TU
 GENERAL CEMENT MFG. CO., 919 Taylor Ave., Chicago, Ill.—NE, TF
 GENERAL COMMUNICATION PRODUCTS CO., 6245 Lexington Ave., Hollywood, Calif.—CP, PM, TP, TU
 GENERAL ELECTRIC CO., Schenectady, N. Y., & Bridgeport, Conn.—EL, MO, RT, TP, TU, WI
 GENERAL INSTRUMENT CORP., 829 Newark Ave., Elizabeth, N. J.—AU
 M. A. GERETT CO., 2947 N. 30th St., Milwaukee, Wis.—NE (long life)
 HARTONE MANUFACTURING CORP., 127-133 S. 15th St., Newark, N. J.—AU, EL
 HARRIS MANUFACTURING CO., 2422 W. 7th St., Los Angeles, Calif.—EL, RL
 HARRISON RADIO CO., 12 W. Broadway, New York, N. Y.—AU, EL, MO, NE, PC, PD, PM, RC, TP, TU, WI
 HETRO ELECTRICAL INDUSTRIES, INC., 5819 N. Drake Ave., Chicago, Ill., *Hetro"—AU, EL, RT
 *HETRO—Hetro Electrical Industries, Inc.
 HERBERT H. HORN, 1201 S. Olive St., Los Angeles, Calif.—PC
 HOWARD RADIO CO., 1731 W. Belmont Ave., Chicago, Ill.—AU, EL, NE, PC, RL, RC
 *INCRIMINATOR—Communications, Inc.
 CHARLES JACK MFG. CORP., 27 E. Philadelphia St., York, Pa.—EL, RC
 J. F. D. MANUFACTURING CO., 4111 Ft. Hamilton Pkwy., Brooklyn, N. Y.—NE
 KADETTE RADIO CORP., 200 Hill St., Ann Arbor, Mich.—EL
 *KNIGHT—Allied Radio Corp.
 LAFAYETTE RADIO CORP., 100 6th Ave., New York, N. Y.—AU, EL, MO, NE, PC, PM, RL, RB, RT, RC, TP, TU, WI
 THE LINCROPHONE CO., INC., 1661 Howard Ave., Utica, N. Y.—AU, EL, TP
 M & H SPORTING GOODS CO., 512 Market St., Phila., Pa.—PC, PM, RT, TU, WI
 MAJESTIC RADIO & TELEVISION CORP., 2600 W. 50th St., Chicago, Ill.—EL, WI
 JOHN MECK INDUSTRIES, 1313 Randolph St., Chicago, Ill.—AU, EL, TP
 MELLOPHONE CORPORATION, 65 Atlantic Ave., Rochester, N. Y.—PC, PM
 CHARLES MICHELSON ELECTRICAL TRANSCRIPTIONS, 67 W. 44th St., New York, N. Y.—EL, RC, SR, TP
 *MICRODYNE—Audak Company
 *MIDWEST—Midwest Radio Corp.
 MIDWEST RADIO CORP., 909 Broadway, Cincinnati, Ohio, *Midwest"—AU
 MILLION RADIO & TELEVISION, 1617 N. Damen Ave., Chicago, Ill.—EL, TU
 *MIRROR—Mirror Record Corp.
 MIRROR RECORD CORP., 58 W. 25th St., New York, N. Y., *Mirror"—NE, RC
 MONTGOMERY WARD & CO., INC., 619 W. Chicago Ave., Chicago, Ill., *Airline"—AU, EL, MO, NE, PC, PD, PM, RL, RT, RC, TU, WI
 *MOTOROLA—Galvin Manufacturing Corp.
 MILES REPRODUCER CO., INC., 812 Broadway, New York, N. Y., *Filmgraph," "Dictafilm"—EL, NE, RC, PM, WI
 MUSIC MASTER MFG. CO., 508 S. Dearborn St., Chicago, Ill.—AU, EL, MO, NE, PC, RT, TP, WI
 MUSICRAFT RECORDS, INC., 10 W. 47th St., New York, N. Y.—EL (custom built), RL, RB, RS, RR, RC
 NASH RADIO PRODUCTS CO., 6267 Gravois Ave., St. Louis, Mo.—NE
 NATIONAL UNION RADIO CORP., 57 State St., Newark, N. J.—AU, EL, RT, TP, TU
 NORTHERN ELECTRIC CO., LTD., 1261 Shearer St., Montreal, Que., Can.—PC, PD, PM, TB
 OFFENBACH ELECTRIC CO., 1452 Market St., San Francisco, Calif.—AU, EL, MO, NE, PC, PM, RT, RC, TU, WI
 OPERADIO MANUFACTURING CO., St. Charles, Ill.—EL
 PACENT ENGINEERING CORP., 79 Madison Ave., New York, N. Y.—EL, PC, PM, RT, TP

RECORDS & RECORD-PLAYING EQUIPMENT



Automatic record changers AU
 Automatic record changers (wireless) AW
 Coin phonographs CP
 Electric phonographs EL
 Electric phonographs (portable) EP
 Fiber-needle cutters FC
 Miniature phonographs MP
 Motors MO
 Needles NE

Please say you saw it in the Radio-Craft "Classified Radio Directory"

• CLASSIFIED RADIO DIRECTORY •

PEERLESS ALBUM CO., INC., 38 W. 21st St., New York, N. Y.—NE, RL, RB
 PERMO PRODUCTS CORP., 6415 Ravenswood Ave., Chicago, Ill.—NE
 PHILCO RADIO & TELEVISION CORP., Tioga & "C" Sts., Phila., Pa.—AU, AW, EL, MO, NE, PC, RB, RT, TU, WI
 PHONOGRAPH NEEDLE MFG. CO., INC., 42-46 Dudley St., Providence, R. I.—NE
 PHONOTONE LABORATORIES, INC., S. E. 15th & State Sts., Washington, Ind.—AU, EL, RT, RC, TP, TU
 POINSETTIA, INC., 97 Cedar Ave., Pitman, N. J.—RC
PRESTO RECORDING CORP., 242 W. 55th St., New York, N. Y.—PM, TP, TU
 B. A. PROCTOR COMPANY, INC., 230 Park Ave., New York, N. Y.—PC, TP, TU
RADIO ELECTRIC SERVICE CO., INC., N. W. Cor. 7th & Arch Sts., Phila., Pa.—AU, EL, MO, NE, PC, PD, PM, RT, RC, TP, TU, WI
 RADIO EQUIPMENT CORP., 326 Elm St., Buffalo, N. Y.—AU, EL, MO, NE, PC, PD, RT, RC, TP, TU, WI
RADIOTONE, INC., 7356 Melrose Ave., Hollywood, Calif.—EL, MO, NE, PC, PM, RC, TP, TU
 RADOLEK COMPANY, 601 W. Randolph St., Chicago, Ill.—AU, EL, MO, NE, PC, PD, PM, RL, RB, RT, RC, TP, TU, WI
 RANGERTONE, INC., 201 Verona Ave., Newark, N. J.—NE, RC
 RAY-LAB COMPANY, Grand Central & 11th St., Elmira Heights, N. Y., **"Ray-Lab"—TP
 *RAY-LAB—Ray-lab Company
 RCA MANUFACTURING CO., INC., Camden, N. J.—AU, EL, NE, PC, PM, RL, TP, TU, WI
 *RECORDIO—Wilcox-Gay Corporation
 RECOTON CORPORATION, 178 Prince St., New York, N. Y.—NE
 REGAL AMPLIFIER MFG. CORP., 14 W. 17th St., New York, N. Y.—EL, PC, RT, TP, TU, WI
 REK-O-KUT CORPORATION, 173 Lafayette St., New York, N. Y.—MO, TU
 *ROCKET—Shure Brothers
 ROCK-OLA MANUFACTURING CORP., 800 N. Kedzie Ave., Chicago, Ill.—AU, CP, EL, TU
 ROWE INDUSTRIES, INC., 3120 Monroe St., Toledo, Ohio—PM
 MAURICE SCHWARTZ & SON, 710-712 Broadway, Schenectady, N. Y.—AU, CP, EL, MO, NE, PC, PD, PM, RL, RB, RT, RC, TP, TU, WI
 E. H. SCOTT RADIO LABS., INC., 4450 Ravenswood Ave., Chicago, Ill.—AU
 SEATTLE RADIO SUPPLY CO., INC., 2117 2nd Ave., Seattle, Wash.—AU, EL, MO, NE, PC, PM, RT, TP, TU, WI
 SELECTAR MANUFACTURING CORP., 30 W. 15th St., New York, N. Y.—PM, TP, TU
 SHELLEY RADIO CO., 1841 S. Flower St., Los Angeles, Calif.—AU, CP, EL, MO, NE, PC, PD, PM, RT, RC, TU, WI
 SHURE BROTHERS, 225 W. Huron St., Chicago, Ill.; **"Shure," "Unidyne," "Uniplex," "Rocket," "Stratoliner," "Super-Level," "Ultrawide-Range," "Zephyr"—PC, PI
 *SHURE—Shure Brothers
 MARK SIMPSON DISTRIB. CO., INC., 16 Hudson St., New York, N. Y.—RT, WI
 SKY CHIEF RADIO CORP., 345 E. 27th St., New York, N. Y.—AU, EL, RB, WI
 SONORA RADIO & TELEVISION CORP., 2626 W. Washington Blvd., Chicago, Ill.—RT, WI
 SOUND APPARATUS CO., 150 W. 46th St., New York, N. Y.—MO, NE, PC, PD, PM, TP, TU
 SPEAK-O-PHONE RECORDING & EQUIPMENT CO., 23 W. 60th St., New York, N. Y.—PC, PM
 *STRATOLINER—Shure Brothers
SUNDT ENGINEERING CO., 4787 Ravenswood Ave., Chicago, Ill.—RC
 SUN RADIO CO., 212 Fulton St., New York, N. Y.—AU, EL, MO, NE, PC, PD, PM, RL, RB, RT, RC, TP, TU, WI
 *SUPER-LEVEL—"Shure Brothers"
 TALK-A-PHONE MANUFACTURING CO., 1219 W. Van Buren St., Chicago, Ill.—EL, RT, WI
 TALKING DEVICES CO., 4447-51 Irving Park Pl., Chicago, Ill.—AU, MP, PM, RT, RC, TP, TU
 TALKING SALES PICTURES, INC., 317-19 E. Ontario St., Chicago, Ill.—EL, TP, TU
TONK MANUFACTURING CO., 1912 N. Magnolia Ave., Chicago, Ill.—RB
 THE TONOFON COMPANY, 15 E. 26 St., New York, N. Y.—DB, NE
 TRANSFORMER CORP. OF AMERICA, 69 Wooster St., New York, N. Y., **"Clarion"—AU, EL, TP, TU, WI
 TROY RADIO & TELEVISION CO., 1144 S. Olive St., Los Angeles, Calif.—EL, RT, WI
 *ULTRAWIDE-RANGE—Shure Brothers
 *UNIDYNE—Shure Brothers
 *UNIPLEX—Shure Brothers
 UNIVERSAL MICROPHONE CO., LTD., 424 Warren Lane, Inglewood, Calif.—MO, NE, TU
 VICTOR ANIMATOGRAPH CORP., Davenport, Iowa—TU
WEBSTER ELECTRIC CO., Clark & DeKoven Ave., Racine, Wisc.—NE, PC, PD, PM

WEBSTER-CHICAGO CORPORATION, 5622 W. Bloomingdale Ave., Chicago, Ill.—AU, MO, PC, PM, RT, TU
 WESTERN SOUND & ELECTRIC LABS., INC., 311 W. Kilbourn Ave., Milwaukee, Wis.—AU, EL, MO, NE, PC, PD, PM
 WILCOX-GAY CORPORATION, Charlotte, Mich., **"Recordio"—RT, WI
 *ZEPHYR—Shure Brothers

RECTIFIERS



Mercury-arc MA
 Metallic (dry-disc) M
 Tube-type T
 Vibrator V

Preceding Listings in RADIO-CRAFT'S CLASSIFIED RADIO DIRECTORY

Sec. I (Revised), April '41:

Amplifiers
 Antennas & Accessories
 Automatic Tuners & Parts
 Auto-Radio Controls
 Aircraft Radio (see Receiving Sets—including Adapters and Converters)
 Battery Chargers (& Parts)
 Batteries (& Cells) Dry & Wet (Storage)
 Books (see Service Manuals, Books & Magazines)
 Cabinets, Cases, Parts & Services
 Chemicals for Radio
 Coils & Transformers (R.F. & I.F.) & Accessories
 Coin Controls (see Records & Record-Playing Equipment; also, Receiving Sets)
 Condensers, Fixed
 Condensers, Variable
 Crystals (Quartz)

Sec. II (Revised), May '41:

Crystals (for detection—receiving) & Detectors
 Dials & Parts
 Electric Fence Controllers
 Electronic Equipment
 Electronic Musical Instruments & Parts
 Facsimile
 Fluorescent & Neon Lamps (& Equipment)
 Frequency Modulation Equipment
 Hardware—Connectors & Misc. Parts & Supplies
 Headphones
 Hearing-Aids
 Hearing-Aid Parts

Sec. III (Revised), June '41:

Insulation
 Intercommunicating Systems
 Kits
 Knobs (see Dials & Parts)
 Line Filters (Also see Noise Elimination Equipment)
 Loudspeakers (& Parts)
 Machinery (Production)
 Magnets & Solenoids
 Metal for Radio
 Metal, Ore, Oil & Leak Locators
 Microphones and Accessories
 Noise-Elimination Equipment
 Paint, Cement & Wax Products
 Plastics
 Plastic Molders

Sec. III, Dec. '40 (in part):

Radio Logs, Maps & Globes
 Receiving Sets (including Adapters & Converters)
 Records & Record-Playing Equipment

Sec. IV, Jan. '41:

Recording Equipment
 Resistors & Volume Controls (Attenuators & Networks)
 Schools
 Service Manuals, Books & Magazines
 Servicing Equipment
 Sound Systems, Amplifiers & Accessories

Sec. V, Feb. '41:

Speakers (& Parts)
 Switches & Relays
 Television
 Test Equipment—Laboratory & Production
 Tools
 Transformers & Chokes
 Transmitters (& Equipment)

Sec. VI, March '41:

Tubes (& Parts)
 Vibrators
 Wire
 Literature

The above back-issues of *Radio-Craft* are available at the regular price of 25c per copy.
 Next month: Section IV of the Classified Radio Directory, revised, with new classifications, and new names and addresses added; and with obsolete listings removed. Reserve your copy, today, from your regular newsdealer.

*AIRLINE—Montgomery Ward & Co., Inc.
 ALLIED RADIO CORP., 833 W. Jackson Blvd., Chicago, Ill., **"Knight"—MA, M, T, V
 AMERICAN COMMUNICATIONS CORP., 123 Liberty St., New York, N. Y.—T
 AMERICAN TELEVISION & RADIO CO., 300 E. 4th St., St. Paul, Minn.—M, V
 ARCO TUBE CO., 227 Central Ave., Newark, N. J.—T
 THE BENWOOD-LINZE CO., 1870 Washington Ave., St. Louis, Mo.—M, T
 CANADIAN MARCONI CO., 211 St. Sacrament St., Montreal, Que., Can.—V
 CONTINENTAL ELECTRIC CO., Geneva, Ill.—MA
 EITEL-McCULLOUGH, INC., San Bruno, Calif.—T
 ELECTRONIC LABORATORIES, INC., 122 W. New York St., Indianapolis, Ind.—V
 ELECTRONS, INC., 127 Sussex Ave., Newark, N. J.—T
 FEDERAL TELEGRAPH CO., 200 Mt. Pleasant Ave., Newark, N. J.—MA, T
 FEDERATED PURCHASER, INC., 80 Park Place, New York, N. Y.—M, T
 FONDA CORPORATION, 29 W. 57th St., New York, N. Y.—M
 GENERAL ELECTRIC CO., Schenectady, N. Y. & Bridgeport, Conn.—MA, T
 GUIDED RADIO CORP., 118 E. 25th St., New York, N. Y.—T
 HARRISON RADIO CO., 12 W. Broadway, New York, N. Y.—M, T
 HARTMAN ELECTRICAL MFG. CO., Mansfield, Ohio—T
 HYTRONIC LABORATORIES, 23 New Derby St., Salem, Mass.—T
 *KNIGHT—Allied Radio Corp.
 LAFAYETTE RADIO CORP., 100 6th Ave., New York, N. Y.—MA, M, T
 P. R. MALLORY & CO., INC., 3029 E. Washington St., Indianapolis, Ind.—M
 MEISSNER MFG. CO., Mt. Carmel, Ill.—V
 MONTGOMERY WARD & CO., INC., 619 W. Chicago Ave., Chicago, Ill., **"Airline"—T
 OFFENBACH ELECTRIC CO., 1452 Market St., San Francisco, Calif.—MA, M, T
 RADIO CITY PRODUCTS CO., INC., 88 Park Pl., New York, N. Y.—M
RADIO ELECTRIC SERVICE CO., INC., N. W. Cor. 7th & Arch Sts., Phila., Pa.—M, T
 RADIO EQUIPMENT CORP., 326 Elm St., Buffalo, N. Y.—T
 RADOLEK COMPANY, 601 W. Randolph St., Chicago, Ill.—MA, M, T
 RAYTHEON PRODUCTION CORP., 420 Lexington Ave., New York, N. Y.—M, MA, T
 RCA MANUFACTURING CO., INC., Camden, N. J.—T
 MAURICE SCHWARTZ & SON, 710-712 Broadway, Schenectady, N. Y.—MA, M, T
 SEATTLE RADIO SUPPLY CO., INC., 2117 2nd Ave., Seattle, Wash.—M, T
 S.O.S. CINEMA SUPPLY CORP., 636 11th Ave., New York, N. Y.—T
 SUN RADIO CO., 212 Fulton St., New York, N. Y.—T
 TAYLOR TUBES, INC., 2341 Wabansia Ave., Chicago, Ill.—T
 THE TURNER COMPANY, 909 17th St., Cedar Rapids, Iowa, **"Turner"—V
 *TURNER—The Turner Company
 UNITED ELECTRONICS CO., 42 Spring St., Newark, N. J.—T
 UNITED TRANSFORMER CORP., 150 Varick St., New York, N. Y.—M
 WESTINGHOUSE ELEC. & MFG. CO., E. Pittsburgh, Pa.—MA, M, T

RELAYS (See Switches & Relays)

Please say you saw it in the Radio-Craft "Classified Radio Directory"

CLASSIFIED RADIO DIRECTORY

Index to advertisers

PUBLISHERS

Amplifier Co. of America.....	5
Book Give-Away Plan.....	29
Data Print Co.....	6
National Plans Inst.....	4
Raderaft Publications, Inc.....	8, 52, 56
Radio & Technical Pub. Co.....	7
Supreme Publications.....	24
Technifax.....	37, 47

RADIO PARTS

Amperite Co.....	19
General Transformer Corporation.....	3
Hammarlund Mfg. Co.....	36
National Union Radio Corp.....	Back Cover
Solar Mfg. Corp.....	24

RADIO RESEARCH

RCA Laboratories.....Inside Front Cover

RADIO SETS

Meissner Mfg. Company.....	27
Midwest Radio Corp.....	19

RADIO SUPPLY HOUSES

Allied Radio Corp.....	43
Burstein-Applebee Co.....	31
Leotone Radio Co.....	40
Hudson Specialties Co.....	49
Lafayette Radio Corp.....	32, 33
Radolek Co.....	24
Wholesale Radio Laboratories.....	17

SCHOOLS

Capitol Radio Eng. Inst.....	7
Commercial Radio Institute.....	6
Coyne Radio School.....	5
Lincoln Engineering School.....	6
National Radio Institute.....	1
National Schools.....	7
New York Y.M.C.A. Schools.....	6
Port Arthur College.....	4
Radio Training Assoc.....	7
RCA Institutes.....	7
Sprayberry Academy of Radio.....	Inside Back Cover

SOUND & RECORDING EQUIPMENT

Amplifier Co. of America.....	37
Erwood Sound Equipment Co.....	30
Lifetime Corp., The.....	30
John Meck Industries.....	31
University Laboratories.....	36
Universal Microphone Co., Ltd.....	31

TEST EQUIPMENT

Radio City Products Co.....	37
Readrite Meter Works.....	24
Supreme Instruments Corp.....	19
Triplett Electrical Instruments Co.....	31
Weston Elec. Instrument Corp.....	23

TUBES

Hygrade Sylvania Corp.....	41
----------------------------	----

MISCELLANEOUS

Classified Section.....	42
Flight Magazine.....	43
Henry Hudson Hotel.....	47
Lancaster Allwine & Rommel.....	30
McGee Radio.....	4
Premium Distributing Service.....	40
Radio Servicemen of America, Inc.....	50
Warner Electric Company.....	6
Wellworth Trading Co.....	36
Woodstock Typewriter Co.....	30

(While every precaution is taken to insure accuracy, we cannot guarantee against the possibility of an occasional change or omission in the preparation of this index.)

RESISTORS—Fixed, Adjustable and Variable (ATTENUATORS & NETWORKS)



Adjustable.....	VA
Attenuators & Networks (precision).....	AT
Fixed, composition.....	F
Fixed, wirewound.....	FI
Industrial, fixed.....	IN
Plug-in (tubes).....	P
Power rheostats.....	PO
Precision.....	PR
Suppressors.....	S
Variable (volume and tone controls, etc.).....	VO

AEROVOX CORPORATION, New Bedford, Mass.—F, FI
 *AIRLINE—Montgomery Ward & Co., Inc. Milwaukee, Wis.—F, S, VA, VO
 ALLEN BRADLEY COMPANY, 1326 S. 2nd St., Milwaukee, Wis.—F, S, VA, VO
 ALLIED RADIO CORP., 833 W. Jackson Blvd., Chicago, Ill.—*“Knight”—AT, F, FI, IN, P, PO, PR, S, VA, VO
 AMERICAN RADIO HARDWARE CO., INC., 476 Broadway, New York, N. Y.—S
 ASSOCIATED RESEARCH, INC., 431 S. Dearborn St., Chicago, Ill.—PR
 *ATOMS—Sprague Products Co.
 *BROWN DEVILS—Ohmite Manufacturing Co.
 CANADIAN RADIO CORP., LTD., 622 Fleet St., W., Toronto, Ont., Can.—AT, S, VA, VO
 THE CARBORUNDUM CO., GLOBAR Div., Niagara Falls, N. Y.—F, IN
 CENTRALAB, DIV. OF GLOBE-UNION, INC., 900 E. Keefe Ave., Milwaukee, Wis.—AT, F, PO, S, VA, VO
 CHICAGO TELEPHONE SUPPLY CO., 1142 W. Beardsley Ave., Elkhart, Ind.—VA, VO
 CINEMA ENGINEERING CO., 1508 W. Verdugo Ave., Burbank, Calif.—AT, FI, PR, VA, VO
 CONSOLIDATED WIRE & ASSOCIATED CORPS., 512 S. Peoria St., Chicago, Ill.—F, FI, IN, S, VA, VO
 CONTINENTAL CARBON, INC., 13900 Lorain Ave., Cleveland, Ohio—F, FI, IN, PR, S
 CRUMPACKER DISTRIB. CORP., 1801 Fannin St., Houston, Tex.—F, FI, S, VO
 THE DAVEN COMPANY, 158 Summit St., Newark, N. J.—AT, FI, PO, PR, VO
 HAROLD DAVIS, INC., 428 W. Capitol St., Jackson, Miss.—AT, F, FI, PR, S, VA, VO
 *DETERMOHM—Ohmite Manufacturing Co.
 DOW RADIO SUPPLY CO., 1759 E. Colorado St., Pasadena, Calif.—AT, FI, IN, P, PO, S, VA, VO
 THE ELECTRO MOTIVE MFG. CO., INC., Williamantic, Conn.—F, S
 ERIE RESISTOR CORP., 644 W. 12th St., Erie, Pa.—F, S
 FEDERATED PURCHASER, INC., 80 Park Pl., New York, N. Y.—AT, F, FI, P, PO, PR, S, VA, VO
 FISCHER DISTRIB. CORP., 222 Fulton St., New York, N. Y.—AT, F, FI, IN, P, PO, PR, S, VA, VO
 FONDA CORPORATION, 29 W. 57th St., New York, N. Y.—AT
 GENERAL ELECTRIC CO., Schenectady, N. Y. & Bridgeport, Conn.—IN, P, PO
 GENERAL RADIO CO., 30 State St., Cambridge, Mass.—AT
 GIRARD-HOPKINS, 1000 40th Ave., Oakland, Calif.—F
 HARDWICK, HINDLE, INC., 40 Hermon St., Newark, N. J.—FI, IN, PO, PR, VA
 HARRISON RADIO CO., 12 W. Broadway, New York, N. Y.—AT, F, FI, IN, PO, PR, VA, VO
 HYTRON CORPORATION, 76 Lafayette St., Salem, Mass.—P
 INSTRUMENT RESISTORS, INC., 25 Amity St., Little Falls, N. J.—AT, FI, IN, PR, VA
 INTERNATIONAL RESISTANCE CO., 401 N. Broad St., Phila., Pa.—AT, F, FI, IN, PO, PR, S, VA, VO
 J. F. D. MANUFACTURING CO., 4111 Ft. Hamilton Pkwy., Brooklyn, N. Y.—P, S
 KELLOGG SWITCHBOARD & SUPPLY CO., 6650 S. Cicero Ave., Chicago, Ill.—IN, PR, VO
 *KNIGHT—Allied Radio Corp.
 *KOOLOHMS—Sprague Products Co.
 LAFAYETTE RADIO CORP., 100 6th Ave., New York, N. Y.—AT, F, FI, IN, P, PO, PR, S, VA, VO
 LECTROHM, INC., 5133 W. 25th Pl., Cicero, Ill.—FI, IN, VA
 M & H SPORTING GOODS CO., 512 Market St., Phila., Pa.—AT, F, FI, IN, P, PO, PR, S, VA, VO
 P. R. MALLORY & CO., INC., 3029 E. Washington St., Indianapolis, Ind.—AT, F, FI, VA, VO
 MICAMOLD RADIO CORP., 1087 Flushing Ave., Brooklyn, N. Y.—FI, P

MONTGOMERY WARD & CO., INC., 619 W. Chicago Ave., Chicago, Ill.—*“Airline”—F, FI, S, VA, VO
 *MULTIVOLTS—Ohmite Manufacturing Co. THE MUTER COMPANY, 1255 S. Michigan Ave., Chicago, Ill.—FI, P
 NATIONAL ELECTRIC CONTROLLER CO., 5307 Ravenswood Ave., Chicago, Ill.—PO
 OFFENBACH ELECTRIC CO., 1452 Market St., San Francisco, Calif.—AT, F, FI, PO, PR, S, VA, VO
 THE OHIO CARBON CO., 12508 Berea Rd., Cleveland, Ohio—F, FI, S
 OHMITE MANUFACTURING CO., 4835 W. Flournoy St., Chicago, Ill.—*“Ohmite,” “Brown Devils,” “Multivolts,” “Determohm,” “Riteohm”—AT, FI, IN, P, PO, PR, VA
 *OHMITE—Ohmite Manufacturing Co.
 PHILCO RADIO & TELEVISION CORP., Tioga & “C” Sts., Phila., Pa.—AT, S, VA, VO
 PRECISION RESISTOR CO., 334 Badger Ave., Newark, N. J.—FI, IN, PR
 RADIO ELECTRIC SERVICE CO., INC., N. W. Cor. 7th & Arch Sts., Phila., Pa.—AT, F, FI, IN, P, PO, PR, S, VA, VO
 RADIO EQUIPMENT CORP., 326 Elm St., Buffalo, N. Y.—AT, F, FI, PO, S, VA, VO
 RADOLEK COMPANY, 601 W. Randolph St., Chicago, Ill.—AT, F, FI, IN, P, PO, PR, S, VA, VO
 RCA MANUFACTURING CO., INC., Camden, N. J.—AT
 *RITEOHM—Ohmite Manufacturing Co.
 REX RHEOSTAT CO., 37 W. 20th St., New York, N. Y.—IN, PO, VA
 ROWE RADIO RESEARCH LAB. CO., 4201 Irving Park Blvd., Chicago, Ill.—AT
 MAURICE SCHWARTZ & SON, 710-712 Broadway, Schenectady, N. Y.—AT, F, FI, IN, P, PO, PR, S, VA, VO
 SEATTLE RADIO SUPPLY CO., INC., 2117 2nd Ave., Seattle, Wash.—AT, F, FI, P, PO, PR, S, VA, VO
 SHALLCROSS MANUFACTURING CO., 10 Jackson Ave., Collingdale, Pa.—AT (fixed), PR
 SHELLEY RADIO CO., 1841 S. Flower St., Los Angeles, Calif.—FI, P, PR, S, VA, VO
 *600 LINE—Sprague Products Co.
 SPRAGUE PRODUCTS CO., N. Adams, Mass.—*“Sprague,” “600 Line,” “Atoms,” “Koolohms,” “Telohmike”—FI, IN
 *SPRAGUE—Sprague Products Co.
 STACKPOLE CARBON CO., Tannery St., St. Mary’s, Pa.—F, VA, VO
 THE STATES COMPANY, 19 New Park Ave., Hartford, Conn.—FI, IN
 SUN RADIO CO., 212 Fulton St., New York, N. Y.—AT, F, FI, IN, P, PO, PR, S, VA, VO
 *TELOHMIKE—Sprague Products Co.
 TILTON ELECTRIC CORP., 15 E. 26th St., New York, N. Y.—F, FI, S, VO
 UTAH RADIO PRODUCTS CO., 812 Orleans St., Chicago, Ill.—F, FI
 WARD LEONARD ELECTRIC CO., 31 South St., Mt. Vernon, N. Y.—FI, IN, PO, VA
 WESTINGHOUSE ELEC. & MFG. CO., E. Pittsburgh, Pa.—IN
 WIRT COMPANY, 5221 Greene St., Phila., Pa.—F, FI, IN, S, VA, VO

IMPORTANT

DO YOU

. . . . find the Classified Radio Directory useful in your work?

Please let us have your vote on whether you wish this department to be continued. Or, if you would prefer to see other material in the same space, kindly let us have your recommendations.

If your answer is “yes!” be sure to let us know at once; otherwise, the readers who prefer other use of these pages may outnumber you.

OPERATING NOTE

Trouble in

. . . . CROSLY 517

I have serviced 3 sets with the same complaint: low volume.

The voltage readings at the tube terminals were a little below normal (about 10 or 15%), and the power transformer was not too hot.

The trouble was due to a partial short-circuit in the high-voltage secondary of the power transformer (as explained on pg. 525, “Modern Radio Servicing,” by Ghirdi). A normal volume was “got” after rewinding the transformer.

JORGE MARTINEZ CAROL, Matanzas, Cuba.

TRAIN NOW FOR TECHNICAL RADIO WORK

**I GIVE YOU FULL
RADIO EQUIPMENT
TO DO OVER 100 ACTUAL EXPERIMENTS**



You Are Pre-conditioned with
RADIO REPAIR EXPERIENCE
... In Your Own Home!

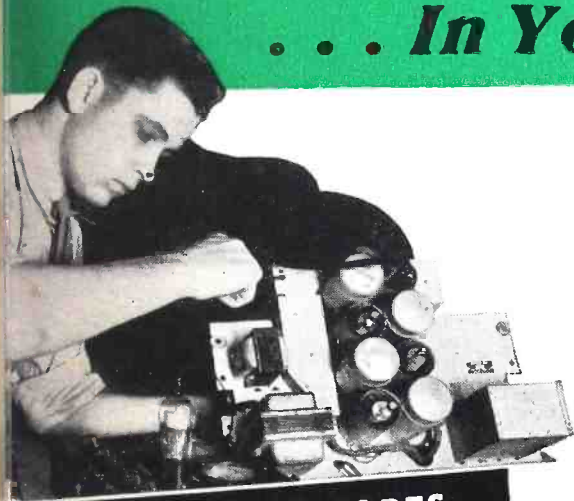

TRAINING PREPARES YOU FOR A BUSINESS OF YOUR OWN OR GOOD RADIO JOBS AT EXCELLENT PAY

Specially designed to help you make fast progress, SPRAYBERRY Training starts right at the beginning of Radio . . . unfolds each subject in a simplified, logical, understandable style. You easily learn in your spare hours . . . AT HOME or AT CAMP. Course covers Television, Frequency Modulation, Signal Tracing, Mobile Radio (Auto-Tank), Aviation Radio, Electronics, Facsimile Radio, Radio Set Repair and Installation Work and other essential subjects.

CASH IN ON RADIO'S RICH OPPORTUNITIES

There is good money to be made. My Training will give you quick access to excellent opportunities. Sprayberry Methods are thorough and practical. Your Training will not interfere with your present work. You get PROFESSIONAL TEST EQUIPMENT plus EXPERIMENTAL OUTFITS. Includes 146 RADIO PARTS for building a complete Receiver, RADIO TOOLS and a modern TESTER-ANALYZER. You also receive 8 BIG SHIPMENTS OF RADIO EQUIPMENT. I show you how to create Radio defects . . . how to correct them, ALL EQUIPMENT BECOMES YOUR PERSONAL PROPERTY!

LEARN MORE ABOUT SPRAYBERRY TRAINING AND HOW EASY IT IS TO START

Regardless of previous education or experience, I can fit you for a good-paying Radio job. My BUSINESS BUILDERS will show you how to put your Equipment to actual use in handling money-making Radio Service Jobs shortly after you begin Training. You can EARN WHILE YOU LEARN. Get complete details AT ONCE . . . in my new, valuable 52-page FREE BOOK. Mail coupon below.

**REMEMBER THE SPRAYBERRY COURSE IS SOLD
UNDER MONEY-BACK AGREEMENT**

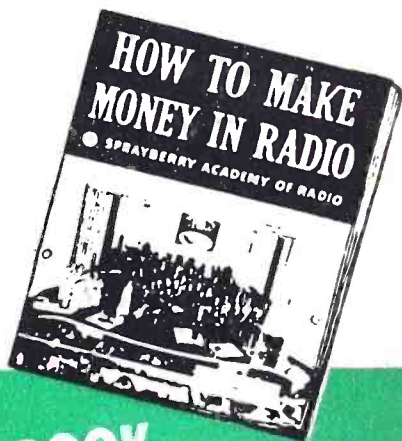

READ THESE LETTERS



"Grossed Between \$150 and \$200"
"Since finishing your training I've started in the Radio repair business. I have about all the work I can take care of. I have grossed between \$150 and \$200 in the last few months in my spare time. I think your Course is 'tops'." W. Francis Waseka, Fountain City, Wisconsin.

"Salary Has Increased"
"Your Radio Training has made it possible for me to make more money. My salary has increased from \$40.00 to around \$50.00 per week. I now have about all the Radio repair work I can handle." Asa Smith, P. O. Box 628, Fort Leavenworth, Ky.



Get **FREE BOOK**

SPRAYBERRY ACADEMY OF RADIO
F. L. Sprayberry, Pres.

420-G University Place, N. W.
Washington, D. C.

Please send me FREE copy of "HOW TO MAKE MONEY IN RADIO".

Name

Address

City

State

Tear off this coupon, mail in envelope or paste on penny postcard.

146 RADIO PARTS

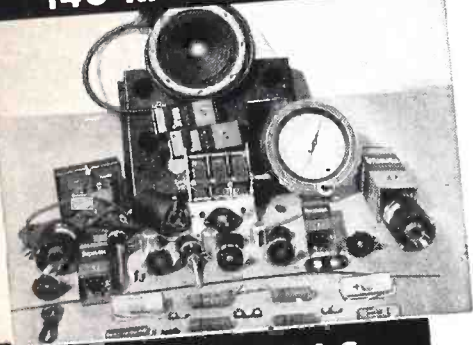

RADIO TOOLS

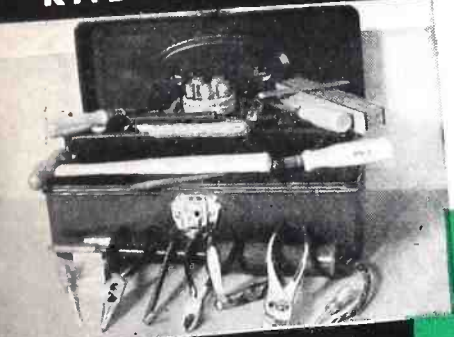

TESTER-ANALYZER



2 more of NATIONAL UNION'S *50,000 Reasons Why!

POPULAR CONDENSER
ASSORTMENT with
TOOL SUPPORTER

2.75

TAKES
BOTH

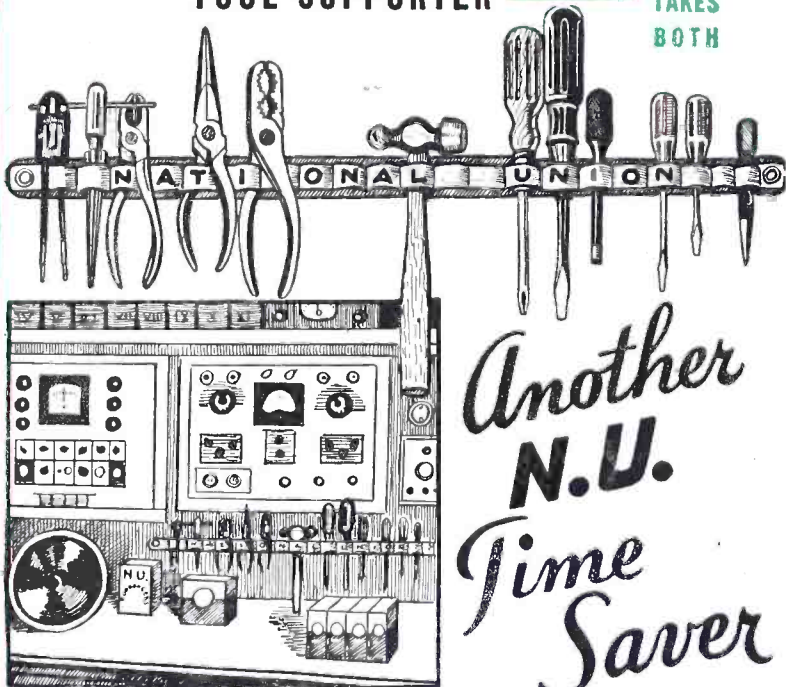

Another
N.U.
Time
Saver

Tool Supporter is 24" long,—holds 20 tools,—sturdily constructed.

THE basic tools of your profession always at your finger-tips — No more hunting — no more wasted time — your tools are where you want them — when you want them.

FOR A LIMITED
TIME ONLY

Get this POPULAR CONDENSER ASSORTMENT
WITH TOOL SUPPORTER — \$5.25
LIST
TOTAL VALUE \$6.10

This fine assortment of popular type N.U. Condensers will move fast, give you a good profit and insure the good will of your customers. If you're already using N.U. condensers, you'll be sure to snap up this offer in a hurry. If you don't know yet how really good N.U. condensers are, here's a great opportunity to try them! The assortment you get on this limited offer consists of:

1—AT1025 1—AT2015 2—AT8450 1—AT2215
2—T601 3—T605 3—T610 1—T625

See your N. U. Distributor or write

AND NOW

A BATTERY MERCHANDISER

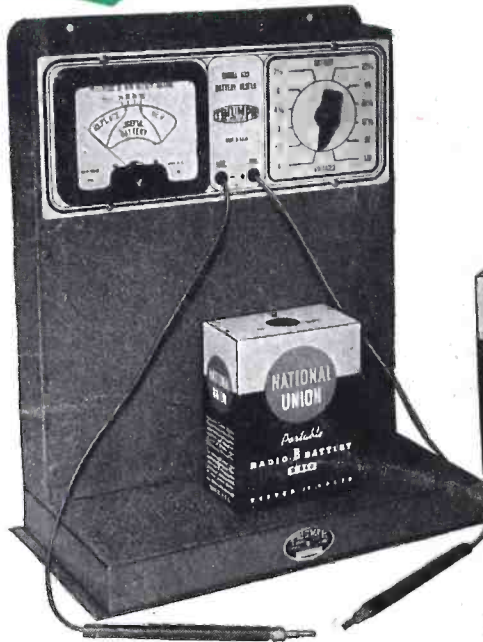

Sells More
Batteries
•
Lets Your
Customer See



win trade
from drug stores
and
filling stations

- Set Switch for Voltage
- Read condition of battery on percentage of useful life meter
- Made by TRIUMPH
- For Counter use or Can Be Mounted on Wall

Only \$9.00 Deposit

Delivery made at once on \$9.00 deposit and order for \$10.00 worth of batteries, dealer prices. Deposit refunded on purchase of 430 points. All purchases of N.U. tubes, condensers and batteries count as points.

MAKE MORE MONEY WITH N.U. BATTERIES
Sold Exclusively to Radio Service Dealers

The N.U. line of radio replacement batteries has been developed exclusively for radio service specialists. All popular types are included. Batteries are attractively packaged in rugged boxes incorporating the standard N.U. color scheme—black and two shades of green.

N.U. Batteries are carefully manufactured from the finest materials obtainable and are fully guaranteed against defects in workmanship and materials. All types equipped with standard plugs for quick and easy replacement installation.

Thoroughly moisture proof for satisfactory and reliable service under all climatic conditions.

Install N.U. replacement batteries for more hours of reliable service and satisfied customers.

N.U. brings you a line of replacement batteries on which you can

make your full radio service profit. It is not necessary now for you to test sets and install batteries without adequate compensation for your time and knowledge.

N.U. has been identified with the radio service dealer and his problems since the beginning. You can definitely make more money handling N.U. products.

SEE YOUR DISTRIBUTOR
OR SEND COUPON

NATIONAL UNION RADIO CORPORATION
57 State Street, Newark, N. J.

I am interested in your new Battery Merchandiser calling for only \$8.00 deposit. Please send more information.

Please have salesman call. RC 7-41

Name

Street Address.....

City..... State.....



Over a 10 year period Servicemen have earned through their purchases of N. U. tubes, batteries and condensers, in excess of 50,000 pieces of high calibre test bench equipment.

© 1941 N.U.R. Corp.

NATIONAL UNION RADIO

57 STATE STREET, NEWARK, N. J.

Corp

ADV Plans, LLC

Copyright Notice:

The entire contents of this CD/DVD are copyright 2014 by ADV Plans, LLC. All Rights Reserved.

Reproduction or distribution of this disk, either free or for a fee is strictly prohibited. We actively monitor and remove listings on eBay thru Vero.

You are free to copy or use individual images in your own projects, magazines, brochures or other school projects.

Only the sellers listed here are authorized distributors of this collection:
www.theclassicarchives.com/authorizedsuppliers

Please view our other products at
www.theclassicarchives.com,
or our ebay stores:

[TheClassicArchives](#)
[ADVPlans](#)
[SuperShedPlans](#)

